

# Major Planned Development Amendment Staff Report

**Date:** April 29, 2026  
**To:** Douglas County Board of County Commissioners  
**Through:** Douglas J. DeBord, County Manager  
**From:** Kati Carter, AICP, Director of Community Development *K Carter*  
**CC:** Matt Jakubowski, AICP, Chief Planner  
Curt Weitkunat, AICP, Long Range Planning Manager  
Steven E. Koster, AICP, Deputy Director of Community Development  
**Subject:** Highlands Ranch Planned Development, 84<sup>th</sup> Amendment  
**Project File:** ZR2026-002

---

<b>Planning Commission Hearing:</b>	<b>April 6, 2026 @ 6:00 p.m.</b>
<b>Board of County Commissioners Hearing:</b>	<b>May 12, 2026 @ 2:30 p.m.</b>

---

## I. EXECUTIVE SUMMARY

The applicant is requesting a Major Planned Development (PD) Amendment to the Highlands Ranch PD (HRPD) to add 350 residential dwelling units to Planning Area 85 (PA 85) of the HRPD. The applicant intends to develop multi-family residential units on two adjacent parcels, 4.61 and 10.2 acres in size, owned by the Englewood McLellan Reservoir Foundation. PA 85 currently allows “multiple-family dwellings” as a use permitted by right but does not have assigned units available for residential development. The amendment request is to add 350 units for future residential development.

The Planning Commission heard the application at its April 6, 2026 public hearing and recommended approval of the proposal by a vote of 5 to 0.

## II. APPLICATION INFORMATION

### A. Applicant

Adam Wallace  
Pagewest Acquisitions, LLC  
414 N. Mill Street, Floor 2  
Aspen, Colorado 81611

### B. Applicant’s Representative

Norris Design  
1101 Bannock Street  
Denver, Colorado 80204

**C. Request**

The applicant requests approval of a Major Amendment to the HRPD through addition of 350 dwelling units to PA 85. The multi-family use is currently allowed in the HRPD by right, but no residential units are assigned to the planning area.

**D. Process**

A Major PD Amendment application is processed pursuant to Douglas County Zoning Resolution (DCZR) Sections 1519 through 1523. The request is considered a major amendment because it increases the total number of units allowed in the HRPD.

Per Section 1522.08 of the DCZR, “The Board shall evaluate the major amendment, referral agency comments, staff report, the Planning Commission recommendation and public testimony, and shall approve, conditionally approve, table for further study, remand to the Planning Commission or deny the amendment. The Board’s comments shall be based on the evidence presented, compliance with the adopted County standards, regulations, policies and other guidelines.”

**E. Location**

PA 85 is located in northwest Douglas County at the intersection of Plaza Drive and Plaza Circle. A Vicinity Map, Zoning Map, and Aerial Map highlight site location and existing conditions and are within the staff report attachments.

**F. Project Description**

The applicant is proposing a Major Amendment to the HRPD through addition of 350 dwelling units to PA 85 within the High Density residential dwelling unit subcategory of the Development Plan Zoning Map. The proposed amended Development Plan Zoning Map is attached to the staff report. The proposal would increase the total number of residential units allowed within the HRPD to 36,418. The applicant intends to develop two parcels, 4.61 and 10.2 acres in size, into 350 multi-family units. The applicant has provided a concept layout of the parcels showing 84 attached townhouse units on the 4.61-acre site, and 264 units within a multi-family building on the 10.2-acre site. The parcels were previously platted as Highlands Ranch Filing No. 157, Lot 3 and Lot 4. A future Site Improvement Plan process would be required for the development of these parcels.

**III. CONTEXT**

**A. Background**

The HRPD was originally approved in 1979. PA 85 was added to the PD in 1988. Residential development, including one-family attached, two-family, and multi-family dwellings were allowed by right in PA 85, but no residential units were assigned to the PA. In 2015, the HRPD was amended to create PA 85-A within a portion of PA 85. With creation of PA 85-A, 285 dwelling units were transferred from PA 84 (north of the site, across C-470) to PA 85-A. In 2015, the Highlands Ranch Filing No. 157 plat was approved covering PA 85-A, the subject parcels, a potential transit station site, and

Ben Franklin Academy. In 2016, PA 85-A was developed into a 285-unit multi-family development.

**B. Adjacent Land Uses and Zoning**

The site is located in an area with a variety of land uses common to an area abutting a major highway and interchange, including multi-family residences, offices, and a hospital. A potential RTD transit station and park-and-ride is proposed adjacent to the site.

**Zoning and Land Use**

Direction	Zoning	Land Use
North	HRPD	Multi-family residential, potential RTD transit station & park-and-ride, C-470 right-of-way
South	HRPD	Multi-family residential and Children’s Hospital
East	HRPD	Right-of-way for C-470 and Kendrick Castillo Way, and parking lot for an office use
West	HRPD	Ben Franklin Academy Charter School

**IV. PHYSICAL SITE CHARACTERISTICS**

**A. Site Characteristics and Constraints**

The subject parcels are undeveloped and vegetated with grasses. The site generally slopes toward C-470 such that the 10-acre parcel is approximately 20 feet lower than the adjoining Children’s Hospital building and the intersection of Plaza Drive and Greensborough Drive. Some portions of the parcel along the C-470 right-of-way include an approximately 40 foot grade differential. These physical conditions do not preclude development of the site.

**B. Access**

The project area includes frontage along both Plaza Drive and Plaza Circle. The applicant’s Traffic Impact Study (TIS) anticipates access to the development exclusively from Plaza Circle. Implementation of intersection and other traffic improvements as identified by TIS will be completed as part of future development of the site, including installation of a traffic signal at the Plaza Drive, Plaza Circle, and Greensborough Drive intersection. County Engineering provided no comments on the proposal, and the TIS is accepted.

**C. Soils and Geology**

Based on a review of the 2040 Douglas County Comprehensive Master Plan (CMP) Class 3 Hazards and Environmental Constraints Map, the property does not include any hazardous geologic or soil conditions.

**D. Drainage and Erosion**

The applicant will be required to meet all engineering requirements for drainage, grading, and erosion control during future development of the site.

**E. Floodplain**

No floodplain is present on the site.

**V. PROVISION OF SERVICES**

**A. Schools**

The Douglas County School District (DCSD) estimates 18 elementary school students, 3 middle school students, and 6 high school students to be generated by this development, with a land dedication requirement of 0.578 acres. DCSD requests a cash-in-lieu of land dedication payment to be determined with a property appraisal at the time of site development.

**B. Fire Protection**

South Metro Fire Rescue (South Metro) provides fire protection services in the area. South Metro has no objection to the proposed development.

**C. Sheriff Services**

The Douglas County Sheriff's Office (DCSO) provides police protection to the site. The DCSO Office of Emergency Management provided a no comment response. DCSO and DCSO E911 provided no response.

**D. Water**

Water service will be provided by the Highlands Ranch Water and Sanitation District (HR Water). The Colorado Division of Water Resources (CDWR) provided a referral response request and has no objection to the proposal.

**E. Sanitation**

Sanitary sewer service is also provided by HR Water.

**F. Utilities**

Utility service providers are Xcel (electrical service and natural gas), AT&T, CenturyLink, and Comcast (phone and data services). AT&T has no conflict with the proposal. Xcel requested a note on future plat documents and indicated that it has a high-pressure gas line on the south side of the development parcels. Future development in this part of the subject parcels will require approvals from Xcel. No response was received from CenturyLink and Comcast.

**G. Parks and Trails**

Douglas County Parks, Trails, and Building Grounds provided referral comments on the proposal and indicated that park land dedication is determined per Douglas County Subdivision Resolution Article 10. Per Article 10, the applicant is required to either provide a park land dedication or an equivalent cash-in-lieu of land dedication. Determination of a park land dedication or cash-in-lieu amount for the proposal will be finalized at the time of site development.

## **VI. PUBLIC NOTICE AND INPUT**

In accordance with DCZR Section 1523, public notice is required to be published in the Douglas County News Press, posted on site by the applicant, and mailed to owners of property abutting and within PA 85.

Courtesy notices of an application in process were also sent to adjacent property owners as part of the referral period. No comments from adjacent property owners or members of the public have been received. Staff provided referrals to the Highlands Ranch Community Association (HRCA), the Highlands Ranch Golf Club HOA (HRGCA), and the Highlands Ranch Backcountry Association (Backcountry). The HRCA Development Review Committee formally approved the proposal and has no objection to the application. No response was received from HRGCA or Backcountry.

All referral agency comments are outlined in the Referral Agency Response Report attached to the staff report. The applicant provided responses to referral comments within a separate letter included in the staff report appendix.

## **VII. PLANNING COMMISSION HEARING**

The Planning Commission heard the proposal at a public hearing on April 6, 2026, and recommended approval of the request by a vote of 5 to 0 with one condition. One member of the public whose child attends Ben Franklin Academy spoke in support of the application. The citizen indicated the proposed traffic signal would benefit traffic control and traffic safety in the area, and that residential development is a complimentary land use to the school.

The Planning Commissioners asked questions regarding the conceptual site plan layout and landscaping, and the height and orientation of the proposed buildings adjacent to Children’s Hospital. The Planning Commissioners generally agreed the proposed traffic signal will be a benefit to the area.

## **VIII. STAFF ANALYSIS**

Per Section 1520 of the DCZR, the following criteria shall be considered for approval of a major amendment:

### **1520.01: Whether the amendment is consistent with the development standards, commitments, and overall intent of the planned development.**

*Staff Comment: The application is consistent with the development standards of the HRPD. The HRPD states an intent “to accommodate a balanced mix of residential, commercial, industrial, educational, recreational, and nonurban land uses,” as well as allowing “opportunities for innovative community design while at the same time being responsive to changing community needs.” It also states, the “New Town of Highlands Ranch is planned and designed to provide for a wide variety and range of housing.”*

*More specific to the subject site, the stated purpose and intent of PA 85 is “to establish land uses and development standards for an Industrial Park” as well as “to encourage the development of businesses and industries primarily engaged in research, development and testing; existing residences and new single-family attached, two-family and multi-family dwellings; compatible light general manufacturing; service industries; warehousing; and construction and activities relating thereto.” While the intent of PA 85 is an industrial park and related uses, it also envisioned residential development, including multi-family development.*

*The applicant’s request is for the addition of residential units to PA 85, not rezoning or allowing new uses. Since PA 85 was established, a diversity of land uses both in and around PA 85 have evolved. Offices, multi-family residences, and a hospital have developed adjacent to PA 85. Within PA 85, a school has been developed, and in PA 85-A (originally part of PA 85) a multi-family project has developed. The applicant’s proposal is consistent with the overall PD intent by contributing to housing options in Highlands Ranch. The applicant’s proposed concept plan includes a mixture of attached townhouse and multi-family units consistent with the purpose of the PD and PA 85, but also reflective of the evolving nature of development in this area.*

**1520.02: Whether the amendment is consistent with the intent, efficient development and preservation of the entire planned development.**

*Staff Comment: As stated above, the overall intent of the PD is a balance of land uses, including a variety of housing options. PA 85’s stated purpose is to be an industrial park, and residential development is anticipated as part of that. The proposal adds residential dwelling units to PA 85, an allowed use, and a use considered in the PA 85 intent statement. This supports the intent, efficient development, and preservation of the entire planned development.*

**1520.03: Whether the amendment will adversely affect the public interest or enjoyment of the adjacent land.**

*Staff Comment: Multi-family development is allowed by right in PA 85 and the site is adjacent to other land uses typically considered compatible to attached townhouse and multi-family development, including a potential transit station and park-and-ride, existing multi-family development, a hospital, and a school. The parcels in question are located adjacent to C-470 and provide a buffer between C-470 and surrounding parcels.*

*During future site design, the applicant will finalize site grading, building orientation, screening, buffers, and building height. The applicant’s concept plan shows lower scale townhouses along Plaza Drive, and a four-story complex of multi-family buildings and open space to the east closer to C-470 and north of Children’s Hospital, although the maximum building height permitted in PA 85 is 90 feet.*

*The applicant has addressed the 1520.03 approval criteria in its narrative and indicates a desire to construct a quality project that blends the proposal with existing development. The applicant will also implement the recommendations of its TIS, including installation of*

*a traffic signal at the intersection of Plaza Drive, Plaza Circle and Greensborough Drive. Implementation of the TIS will mitigate potential impacts on neighboring property owners.*

**1520.04: Whether the sole purpose of the amendment is to confer a special benefit upon an individual.**

*Staff Comment: The application does not as its sole purpose confer a benefit upon an individual. The proposal supports overall development of the HRPD and provides 350 additional housing units to Highlands Ranch.*

**1520.05: For applications proposing an increase in the intensity of allowed land-uses, including changes in densities, whether the amendment is consistent with the water supply standards in Section 18A, Water Supply Overlay District, of this Resolution.**

*Staff Comment: DCZR Section 1803A establishes approval standards to be used in the evaluation of land use applications reviewed under Section 18A. HR Water has the capacity to serve the proposed development and has issued a will serve letter as requested by the applicant.*

**1803A.01: The applicant has demonstrated that the water rights can be used for the proposed uses.**

*Water and sewer service are to be provided by HR Water.*

**1803A.02: The reliability of a renewable water right has been analyzed and is deemed sufficient by the County based on its priority date within the Colorado System of Water Rights Administration.**

*No new renewable water rights are being used to serve this project. HR Water has identified renewable water rights that it currently owns within its portfolio of water rights.*

**1803A.03: The Water Plan is deemed adequate and feasible by the County to ensure that water supply shortages will not occur due to variations in the hydrologic cycle.**

*A water plan is not required when water is provided by a District.*

**1803A.04: The Water Plan is sufficient to meet the demand applicable to the project based on the minimum water demand standards in Section 1805A herein.**

*A water plan is not required when water is provided by a District.*

**1520.06: Whether the public facilities and services necessary to accommodate the proposed development will be available concurrently with the impacts of such development.**

*Staff Comment: The site is in a developed area connected to infrastructure. HR Water will provide water and sewer service. The application has been reviewed by South Metro Fire, utility providers, and the Douglas County Sheriff's Office. None of these agencies expressed an inability to serve the development. Douglas County School District and Douglas County Parks, Trails, and Building Grounds will determine land dedication or cash-in-lieu fees as part of future development.*

**1520.07: Whether the roadway capacity necessary to maintain the adopted roadway level of service for the proposed development will be available concurrently with the impacts of such development.**

*Staff Comment: Public Works Engineering has reviewed the applicant’s TIS. The applicant will implement the recommendations proposed within the TIS in conjunction with future development of the site.*

**IX. STAFF ASSESSMENT**

Staff has evaluated the request in accordance with Section 15 of the DCZR. Should the Board find that the approval standards for a Major PD Amendment are met, the following conditions should be considered for inclusion in the Board motion:

1. Prior to recordation, all technical corrections to the Highlands Ranch Planned Development, 84th Amendment document shall be made to the satisfaction of Douglas County.
2. All commitments and promises made by the applicant or the applicant’s representative during the public hearing and/or agreed to in writing and included in the public record have been relied upon by the Board of County Commissioners in approving the application; therefore, such approval is conditioned upon the applicant’s full satisfaction of all such commitments and promises.

<b><u>ATTACHMENTS</u></b>	<b>PAGE</b>
Douglas County Land Use Application .....	9
Applicant’s Narrative .....	10
Vicinity Map .....	16
Zoning Map .....	17
Aerial Map.....	18
Referral Agency Response Report .....	19
Referral Response Letters.....	24
Applicant Response to Referral Comments.....	47
Neighborhood Meeting Summary .....	53
Traffic Impact Study .....	54
Water Documentation .....	282
Concept Site Plan .....	290
Planned Development Redlined Exhibit .....	291
Planned Development Clean Exhibit .....	292

# Land Use Application

Please complete, sign, and date this application. Return it with the required items on the Submittal Checklist to [planningsubmittals@douglas.co.us](mailto:planningsubmittals@douglas.co.us). Submittals may also be mailed or submitted in person to Planning Resources.

## PROJECT INFORMATION

Project Type: \_\_\_\_\_

Marketing Name: \_\_\_\_\_

Presubmittal Review Project Number: \_\_\_\_\_

## PROJECT SITE

Address: \_\_\_\_\_

State Parcel Number(s): \_\_\_\_\_

Subdivision/Block#/Lot# (if platted): \_\_\_\_\_

## PROPERTY OWNER(S)

Name(s): \_\_\_\_\_

Address: \_\_\_\_\_

Phone: \_\_\_\_\_

Email: \_\_\_\_\_

## AUTHORIZED REPRESENTATIVE

Name: \_\_\_\_\_

Company: \_\_\_\_\_

Address: \_\_\_\_\_

Phone: \_\_\_\_\_

Email: \_\_\_\_\_

*A notarized Letter of Authorization is required from the property owner, unless the owner is acting as the representative.*

## ACKNOWLEDGMENT

To the best of my knowledge, the information contained on this application is true and correct. I have received the County's information sheet regarding the *Preble's Meadow Jumping Mouse*.

Adam Wallace  
Applicant's Signature

\_\_\_\_\_  
Date

**NOTICE: Douglas County Planning does not charge "Approval" fees. Douglas County communicates through our official email accounts ending in @douglas.co.us; beware of phishing scams using similar addresses. If you have questions or concerns about the validity of an email or invoice, please call our public outreach and assistance team at 303-660-7460 or email [planning@douglas.co.us](mailto:planning@douglas.co.us).**

**Project Number (Office Use Only): ZR2026-002**



February 10, 2026

Douglas County, Department of Community Development  
100 Third Street #220  
Castle Rock, CO 80104

**RE: NARRATIVE FOR AMENDMENT 84 TO THE HIGHLANDS RANCH PLANNED DEVELOPMENT**

Dear Douglas County Department of Community Development,

On behalf of Pagewest Acquisitions, LLC, Norris Design is pleased to present the following proposal to amend the Highlands Ranch Planned Development to allow for multi-family development in Planning Area 85 (PA-85).

<p><b>OWNER:</b> Englewood McLellan Reservoir Foundation 1000 Englewood Parkway Englewood, CO 80110</p>	<p><b>DEVELOPER:</b> Pagewest Acquisitions, LLC 414 N Mill Street, Floor 2 Aspen, CO 81611 Contact: Adam Wallace, Partner <a href="mailto:adam@pagewestco.com">adam@pagewestco.com</a> 512-788-1428</p>
<p><b>ENTITLEMENTS:</b> Norris Design 1101 Bannock St. Denver, CO 80204 Contact: Mallory Mooney, Project Manager <a href="mailto:mmooney@norris-design.com">mmooney@norris-design.com</a> 720-782-0059</p>	<p><b>CIVIL ENGINEER:</b> Kimley-Horn 1125 17th St #1400 Denver, CO 80202 Contact: Eric McDaniel, PE <a href="mailto:eric.mcdaniel@kimley-horn.com">eric.mcdaniel@kimley-horn.com</a> 720-943-5657</p>

**PROJECT OVERVIEW**

The subject Site is composed of two separate parcels of land currently owned by the Englewood McLellan Reservoir Foundation. Parcel #1 (County Parcel #2229-042-08-001) is roughly 4.61 acres in size and Parcel #2 (County Parcel #2229-042-09-002) is roughly 10.2 acres in size. The Site is located within Planning Area 85 of the Highlands Ranch Planned Development.

The applicant team is exploring a multifamily development for the two parcels and intends to amend the Highlands Ranch Planned Development to support this development. This Amendment proposes the addition of 350 residential dwelling units to the Highlands Ranch Planned Development, increasing the Total Dwelling Units of the PD from 36,068 to 36,418. These additional residential units would be designated to Planning Area 85 so that the Site may be developed with multifamily residential through a future land use application.

This Amendment does not propose to rezone land within the Highlands Ranch Planned Development, it simply increases the allowed number of dwelling units by roughly 1%. Multifamily residential is already a Use Permitted by Right in Planning Area 85 per Section X-B of the Highlands Ranch Planned Development.



The applicant team has met with the Highlands Ranch Metro District (HRMD) and Highlands Ranch Water (HR Water), who confirmed that there are adequate taps and sufficient water for a residential development of up to 400 units. The Site has existing infrastructure to serve a future development of this size.

Community input is an important part of the development process. Following the submittal of this application, the development team intends to meet with adjacent businesses, the Highlands Ranch Community Association, and the community.

### **TRAFFIC, ACCESS AND CIRCULATION**

The Site is accessed through existing roadways – Plaza Drive and Plaza Circle. The nearby connection of Kendrick Castillo Way is an important thoroughfare in Highlands Ranch, with C-470 also nearby as a major regional highway. One item to note is that the Applicant intends to improve the southeast intersection of Plaza Drive and Plaza Circle with a 4-way traffic signal. Additionally, at the northwest intersection of Plaza Drive and Plaza Circle, the Applicant would like to restrict left turn movements during peak travel times, similar to what the Ben Franklin Academy exit does through signage as shown below:



Details for these improvements will come at the time of the future site plan submittal.

Access and circulation, which will be detailed in a future site plan will comply with all applicable local, state and emergency regulations at the time of Site Improvement Plan. The development team will work with the County and the Metro District on requirements.

### **PROJECT IMPROVEMENTS**

The proposed Amendment will allow the Site to be developed as a multifamily residential community. The development team is proposing a community that will complement the existing character of the neighborhood while delivering a premier experience for its residents. The development will enhance the area by providing high-quality housing that supports growing



nearby employers, promotes a healthy lifestyle, minimizes traffic impact, and fits within the area's existing infrastructure capacity.

The architecture will utilize premium materials, including masonry, glazing, and cementitious siding. Ample on-site parking, including covered garages and surface spaces, will fully accommodate residents and guests, preventing any overflow onto surrounding streets.

The community will feature a state-of-the-art fitness center equipped with weight training, cardio facilities, and spin bikes as well as an outdoor pool and spa, dog parks, pet wash stations, pedestrian-friendly pathways, bicycle storage and repair stations, and wellness-focused gathering spaces such as yoga areas and passive outdoor courtyards.

The proposed community will bring much needed housing for nearby employment centers, prioritize high-quality design, thoughtful infrastructure integration, and lifestyle-driven amenities in a location well suited for density.

### **CONFORMANCE WITH THE GOALS, OBJECTIVES, AND POLICIES OF THE COMPREHENSIVE PLAN**

The proposed PD Amendment is in conformance with the Douglas County 2040 Comprehensive Master Plan in the following ways.

#### **Goal 2-1: Improve and enhance existing infrastructure; support healthy living; reduce vehicle miles travelled; maintain air quality standards; and conserve open space.**

The project is proposed within the Primary Urban Area (PUA), in accordance with Objective 2-1A to "Direct urban-level development to designated urban areas". Additionally, as the Site is in close proximity to two major hospital systems, a school, and one of the area's premier employment centers, the community intends for future residents to live and work in the same area. This supports healthy living and reduces vehicle miles traveled while maintaining air quality standards. Further, future residential development of the Site is intended to be programmed with abundant fitness and recreation facilities both indoors and outdoors.

#### **Goal 2-5: Minimize the impact of development on natural and historic resources.**

The proposed PD Amendment will allow future residential development of the Site which will not impact natural and historic resources. The Site is already served by existing streets and it is not located near environmentally or visually-sensitive lands, making it an appropriate location for development.

#### **Policy 2-5A.5: Encourage compact development patterns that conserve natural resources.**

Future residential development of the Site would be infill development which is more sustainable than a greenfield development because instead of building new infrastructure, it will improve the existing infrastructure that is already in place.

#### **Goal 2-6: Achieve compatibility between residential and nonresidential land uses, in terms of land use and design.**

The Site is adjacent to existing higher-density residential development. The proposed PD Amendment will allow for higher-density residential ensuring that future development is consistent with surrounding land uses. The proximity of a nearby school, hospital, office, and retail will provide services to future residents as well as housing for the nearby employers.

#### **Objective 2-6F: Ensure residential and nonresidential building design, scale, and orientation are compatible with the natural and built environment.**



The PD Amendment only proposes to add residential units to PA-85 of the Highlands Ranch Planned Development. No changes to the existing residential standards of the Highlands Ranch PD are proposed with this application. Future residential development will comply with the existing standards of the PD ensuring development will be compatible with the natural and built environment of the area.

**Policy 2-7B.3: Create opportunities for residents to access transportation and community services**

Given the Site's location, future development would provide residents with excellent access to transportation and community services. The Site is located close to the intersection of Kendrick Castillo Way, a major arterial, and C-470, a state freeway, offering future residents' easy access to major road corridors in the region. The parcel directly north of the Site is owned by RTD and if it were to ever develop as a transit center, it would provide future residents with adjacent transit access. For bicyclists and other outdoor enthusiasts, Fly'n B Park is located to the north of the Site along Plaza Drive. The park is a trailhead for the Highline Canal, a major regional trail corridor throughout the larger metro area. To the east of the Site is the nearby Central Park retail center as well as the Arc 470 business park campus.

**Goal 2-9: Ensure development occurs concurrently with essential services and infrastructure.**

The applicant team has met with the Highlands Ranch Metro District (HRMD) and Highlands Ranch Water (HR Water), who confirmed that there are adequate taps and sufficient water for residential development of up to 400 units. The project site has existing infrastructure to serve a future development of this size.

**COMPLIANCE WITH CRITERIA FOR APPROVAL**

**1. Whether the Amendment is consistent with the development standards, commitments, and overall intent of the planned development.**

The proposed Amendment is consistent with the development standards, commitments, and overall intent of the Highlands Ranch Planned Development (HRPD). The HRPD Master Plan and Development Guide provides a comprehensive controlling document for the regulation of land within the HRPD area and this Amendment to the HRPD proposes development consistent with the overall intent of the Planned Development. The HRPD features lots and standards consistent with what is proposed by this Amendment. The proposed amendment will allow for the subject property to be developed in a land use pattern that was approved previously and that is in concert with the surrounding area. The development standards for this property will be those found in Section VI – High Density Residential of the HRPD Development Guide and represent a development approach for the subject property that is consistent with the surrounding area.

**2. Whether the Amendment is consistent with the intent, efficient development and preservation of the entire planned development.**

The proposed Amendment is consistent with the intent, efficient development and preservation of the entire Planned Development. One of the stated Objectives of the Highlands Ranch Planned Development Guide is to be "...responsive to changing community needs". The Site has remained vacant for many years, while a need for housing, particularly near major employers, has grown. This demonstrates a changing community need for the planning area. Furthermore, a portion of PA 85 has already been re-designated for high-density housing, and the proposed multifamily use is consistent with the surrounding area, which includes the Creekside at Highlands Ranch Apartments, Longs Ridge Apartments, Solana Lucent Sation Apartments, and Windcrest Summit Square Apartments.



The proposed land use does not represent a significant change from the existing land use pattern and allows for the continued success of the HRPD by activating a long vacant property with needed housing. Also, future residential development of the Site is supported by the capacity of existing infrastructure which aligns with the Highlands Ranch Planned Development's Legislative Intent C.5. to "Encourage a more efficient use of land and public services".

**3. Whether the Amendment will adversely affect the public interest or enjoyment of the adjacent land.**

The proposed Amendment will not adversely affect the public interest or enjoyment of the adjacent land. The proposed Amendment allows for the Site to develop as a residential community similar in size and character to existing nearby uses. The proposed land use is compatible with the surrounding area and will not increase or change the nature and character of the area. Included with this application is a Traffic Study which revealed that the proposal would have minimal impact on the existing traffic patterns in Highlands Ranch. Potential roadway improvements such as a full service intersection at Plaza Circle and Plaza Drive will improve traffic safety in the area. The intent of the proposal is to allow for the development of the subject property in a manner consistent and in harmony with the surrounding area.

**4. Whether the sole purpose of the Amendment is to confer a special benefit upon an individual.**

The sole purpose of the Amendment is not to confer a special benefit upon an individual. The purpose of this Amendment is to allow for the subject property to be developed in a manner consistent with the surrounding area. The benefit is to the entire community by adding additional and more diverse housing to Highlands Ranch.

**5. For applications proposing an increase in the intensity of allowed land uses, including changes in densities, whether the Amendment is consistent with the water supply standards in Section 18A, Water Supply Overlay District, of this Resolution.**

A meeting was held with the Highlands Ranch Water (HR Water) on December 20, 2024. HR Water expressed their capacity to serve this proposed community and stated they will need the final unit count plus the size of proposed irrigation meters and the proposed tap for community center in order to issue a will serve letter. Once this information is available, the development team will provide it to HR Water to obtain the will serve letter and comply with the water supply standards in Section 18A.

**6. Whether the public facilities and services necessary to accommodate the proposed development will be available concurrently with the impacts of such development.**

Public facilities and services such as school and fire protection are available and have the capacity to support the proposed development. Please see the attached will serve letter from South Metro Fire Rescue stating the capacity to provide fire prevention, fire suppression, emergency medical, and special team response services to properties within its jurisdictional boundaries of which the subject parcel is within. A will serve letter from the Douglas County School District is also included with the application materials.

**7. Whether the roadway capacity necessary to maintain the adopted roadway level of service for the proposed development will be available concurrently with the impacts of such development.**



Included with this application is a detailed traffic study that examined the impact of proposal on the roadway level of service available in the area. The adopted roadway level of service for the proposed development will be available concurrently with the impacts of the development.

We are excited to work with Douglas County again to make this project a success, and we look forward to meeting with you.

Sincerely,  
Norris Design

*Mallory Mooney*

Mallory Mooney  
Project Manager

# Comprehensive Master Plan Land Use Reference Map

## Comprehensive Master Plan Areas

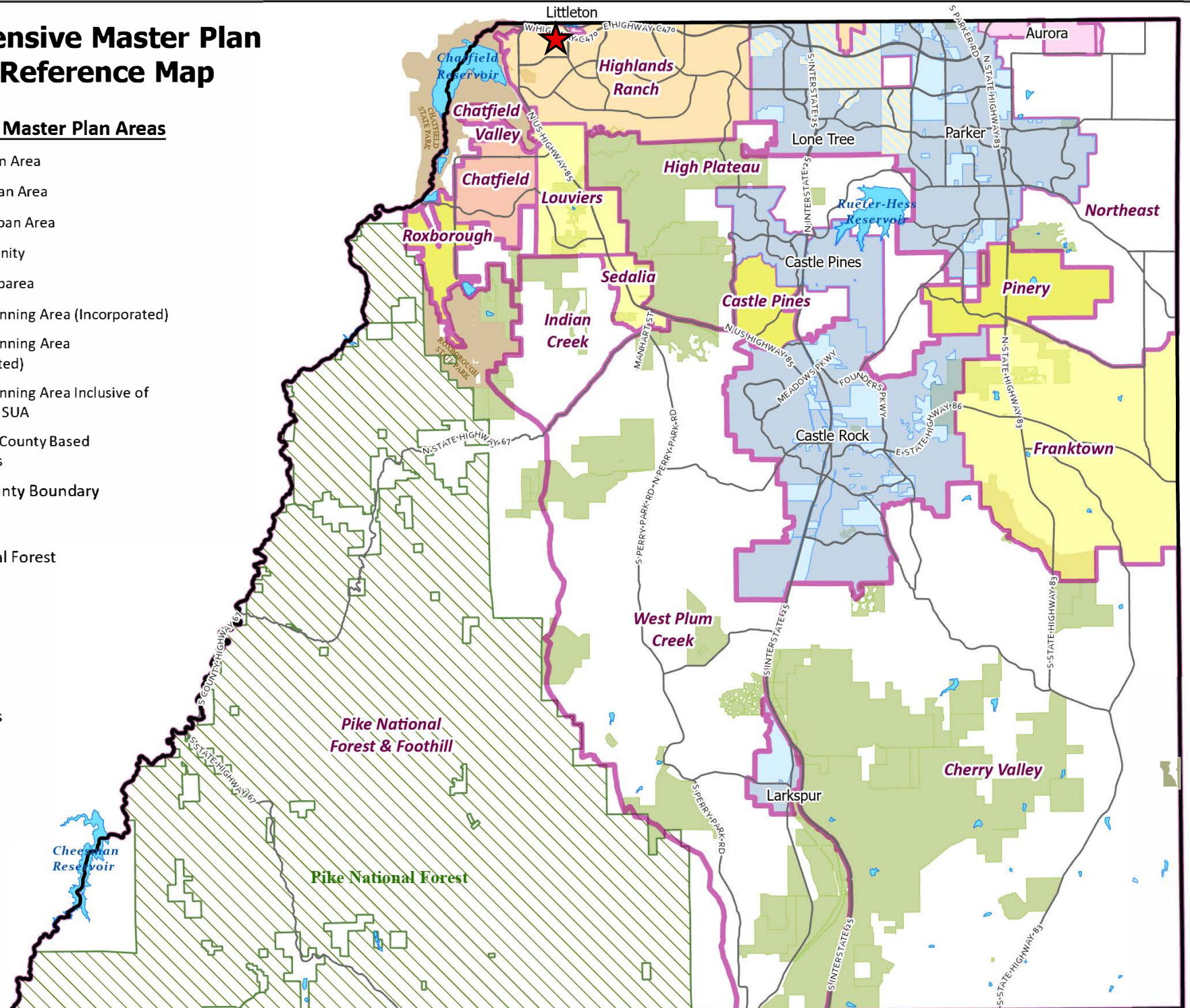
- Primary Urban Area
- Chatfield Urban Area
- Separated Urban Area
- Rural Community
- Nonurban Subarea
- Municipal Planning Area (Incorporated)
- Municipal Planning Area (Unincorporated)
- Municipal Planning Area Inclusive of County PUA / SUA
- Non-Douglas County Based Municipalities
- Douglas County Boundary

## Parks

- Pike National Forest
- State Parks
- Open Space
- Lakes

## Roadways

- Major Roads



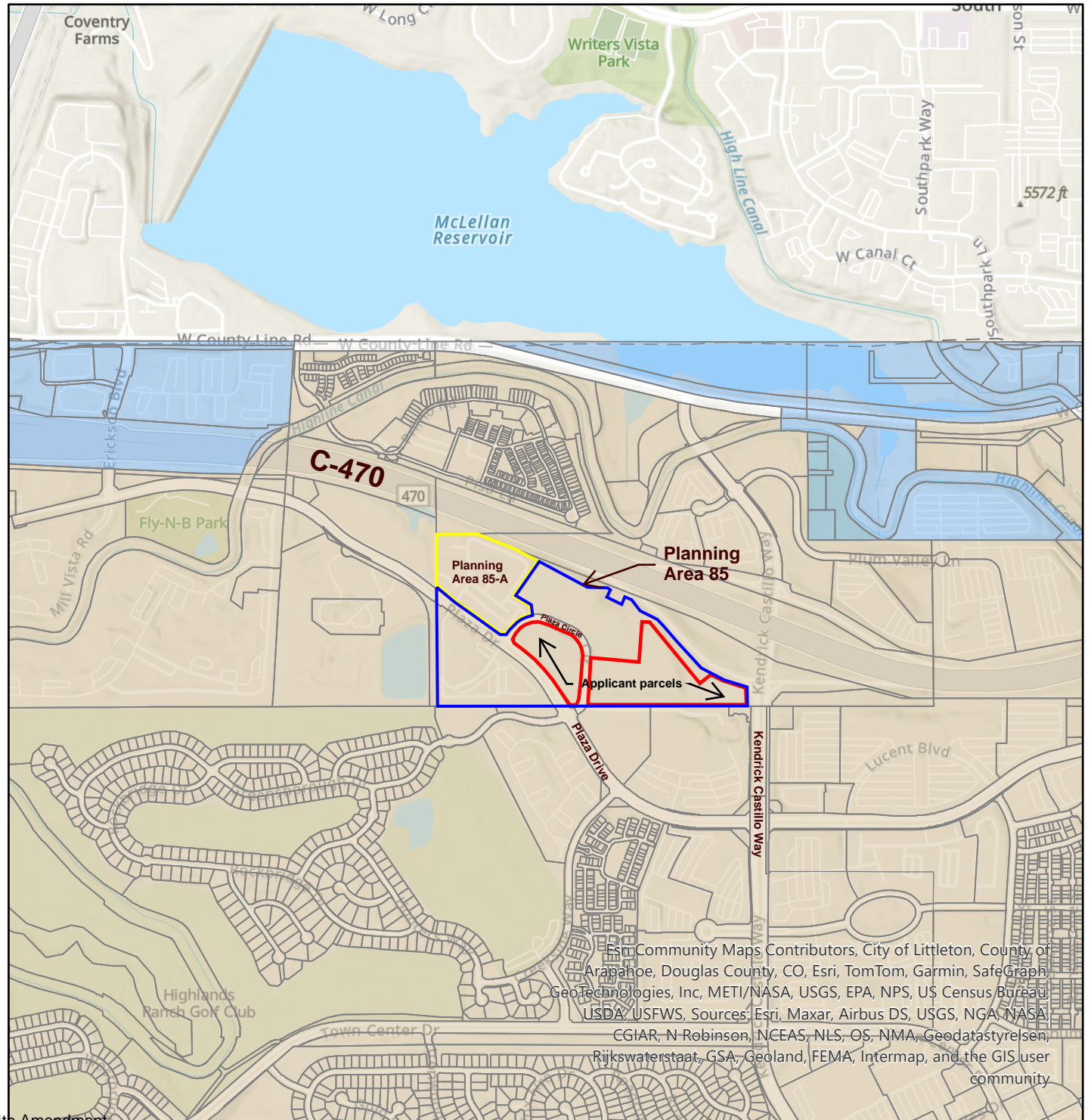
# Highlands Ranch Planned Development, 84th Amendment

ZR2026-002  
Zoning Map



## LEGEND

- A1 - AGRICULTURAL ONE
- CTY
- PD - PLANNED DEVELOPMENT
- PLANNING AREA 85
- APPLICANT PARCELS
- PLANNING AREA 85-A






Esri, Community Maps Contributors, City of Littleton, County of Arapahoe, Douglas County, CO, Esri, TomTom, Garmin, SafeGraph, GeoTechnologies, Inc, METI/NASA, USGS, EPA, NPS, US Census Bureau, USDA, USFWS, Sources: Esri, Maxar, Airbus DS, USGS, NGA, NASA, CGIAR, N-Robinson, NCEAS, NLS, OS, NMA, Geodatastyrelsen, Rijkswaterstaat, GSA, Geoland, FEMA, Intermap, and the GIS user community

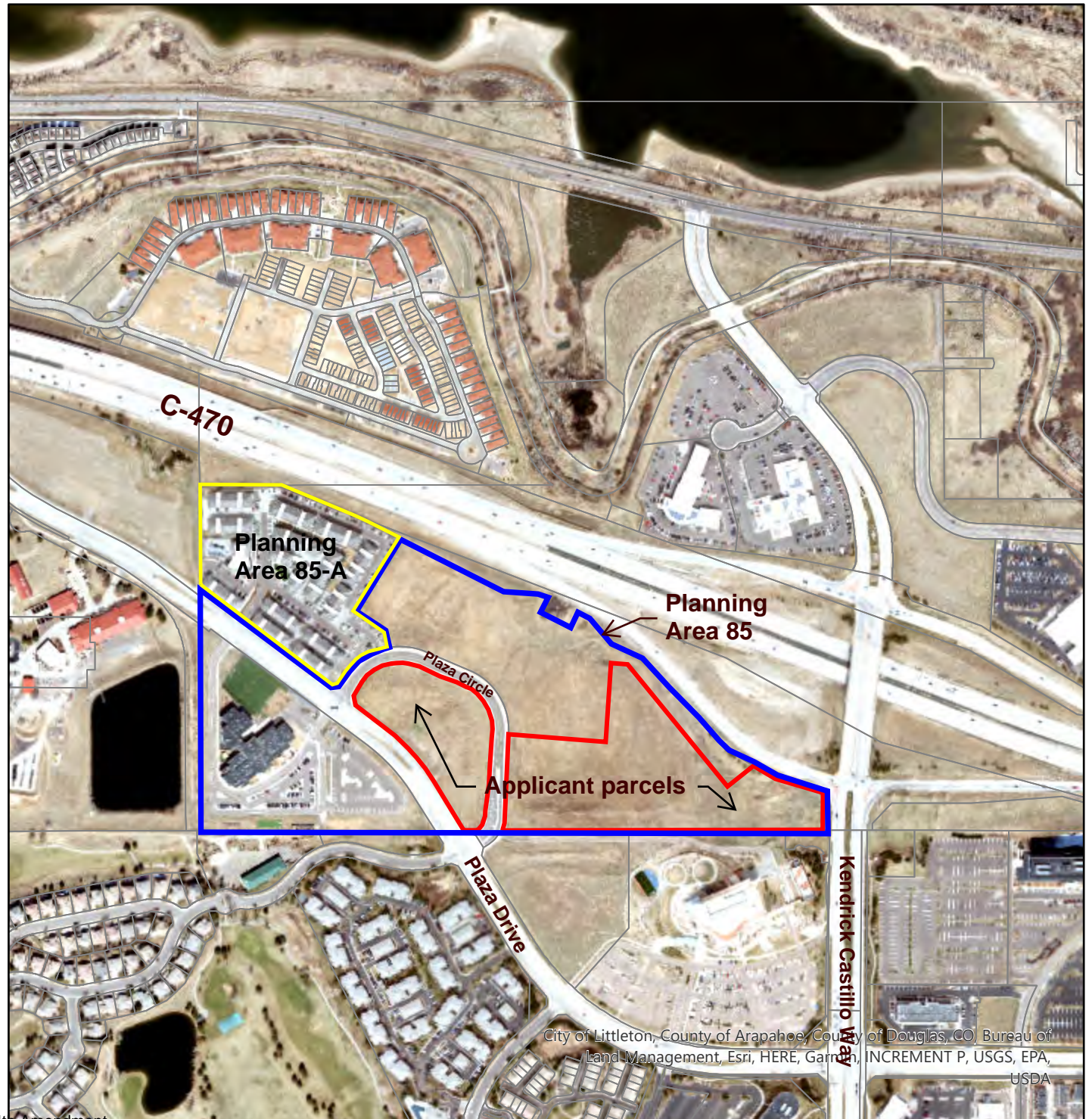
# Highlands Ranch Planned Development, 84th Amendment

ZR2026-002  
Aerial Map



## LEGEND

-  PLANNING AREA 85
-  APPLICANT PARCELS
-  PLANNING AREA 85-A



City of Littleton, County of Arapahoe, County of Douglas, CO, Bureau of  
Land Management, Esri, HERE, Garmin, INCREMENT P, USGS, EPA,  
USDA

**Referral Agency Response Report**

**Project Name:** Highlands Ranch Planned Development, 84th Amendment

**Project File #:** ZR2026-002

**Date Sent:** 02/10/2026

**Date Due:** 03/03/2026

Agency	Date Received	Agency Response	Response Resolution
Addressing Analyst	02/12/2026	No Comment.	No action necessary.
Arapahoe County Engineering Services Division		No Response Received.	No action necessary.
Arapahoe County PWD/ Planning		No Response Received.	No action necessary.
AT&T Long Distance - ROW	02/12/2026	Following is a summary of referral comments received from AT&T. See full letter for detail.  No conflicts.	No action necessary.
Backcountry Association, Inc		No Response Received.	No action necessary.
Building Services	02/13/2026	No Comment.	No action necessary.
CenturyLink		No Response Received.	No action necessary.
City of Centennial	02/17/2026	No Comment.	No action necessary.
Colorado Department of Transportation CDOT-Region # 1	02/12/2026	Received (verbatim response): I have reviewed the referral for Highlands Ranch Planned Development, 84th Amendment with PD to add 350 residential units to PA 85 and have the following comments.  <ul style="list-style-type: none"> <li>• Due to the proximity of this development to the C470 EB ramp we would like to review the drainage report to confirm no negative impact.</li> <li>• Any signing for this development visible to the state highway must be compliant with the state rules for outdoor advertising per 2 CCR 601-3.</li> <li>• We ask that the county continue to monitor cumulative impact of development on the Kendrick Castillo Way and C470 interchange.</li> </ul> Thank you for the opportunity to review this referral.	Applicant will provide drainage reports to CDOT during future development of the site and will comply with CDOT rules for outdoor advertising as necessary. The Applicant's traffic study incorporates both eastbound and westbound ramps at Kenrick Castillo Way and C-470. County Engineering has accepted the findings of the applicant's traffic study.
Colorado Division of Water Resources	03/09/2026	Following is an excerpt from the referral response received from the Colorado Division of Water Resources (CDWR). See full letter for detail.  Our office has no comments regarding this referral.	No action necessary.

**Referral Agency Response Report**

**Project Name:** Highlands Ranch Planned Development, 84th Amendment

**Project File #:** ZR2026-002

**Date Sent:** 02/10/2026

**Date Due:** 03/03/2026

Agency	Date Received	Agency Response	Response Resolution
Comcast		No Response Received.	No action necessary.
Douglas County Health Department		No Response Received.	No action necessary.
Douglas County Housing Partnership		No Response Received.	No action necessary.
Douglas County Parks and Trails	02/25/2026	<p>Received (verbatim response):                      Applicant would be responsible for meeting park land dedication as outlined in Article 10 of the Douglas County Subdivision Resolution.</p> <p>1003 Parks                      Whenever land is proposed for residential or non-residential use, the owner of the land is to provide land or cash-in-lieu of land for active and specialized recreation generated by the proposed use. In general, these lands need to be suitable for the development of active play areas, trails, or in some instances serve to preserve unique landforms or natural areas. Where no suitable land is available in a residential or non-residential development, cash-in-lieu of land or of equivalent value in the donation of recreational facilities may be substituted at the County's discretion. Additional dedication for open land may be required by the Board if deemed necessary to preserve areas of special countywide significance (refer to Sections 1003.11.5 and 1003.12.5 of these regulations).</p> <p>1003.01 The following formula is used to calculate the minimum amount of land dedication required in residential developments which is deemed necessary to provide the needed parks. This formula is based on 15 acres/1000 population.</p> <p>Local Park = Dwelling units x 0.015 acres/unit                      Regional Park = Dwelling units x 0.030 acres/unit                      Total = Dwelling units x 0.045 acres/unit</p> <p>The Board reserves the right to adjust the acreage requirement between local and regional park categories as deemed necessary to meet specific needs and to determine the amount of developed park acreage required. The Board may also consider alternative park land dedication formulas for multi-family development proposals.</p>	Final determination of land dedication or parks cash-in-lieu will occur during any future Site Improvement Plan for development of the property.

**Referral Agency Response Report**

**Project Name:** Highlands Ranch Planned Development, 84th Amendment

**Project File #:** ZR2026-002

**Date Sent:** 02/10/2026

**Date Due:** 03/03/2026

Agency	Date Received	Agency Response	Response Resolution
Douglas County School District RE 1	03/09/2026	<p>Following is a summary of the referral response received from the Douglas County School District (DCSD). See the letter for full detail.</p> <p>DCSD calculated a land dedication requirement of 0.578 acres from the 18 elementary, 3 middle school, and 6 high school students generated from the development. DCSD requests cash-in-lieu of land dedication per Douglas County Subdivision Resolution 1004.05.03 at Site Plan approval. DCSD has no objection to the proposal provided the applicant agrees to this request.</p>	Final cash-in-lieu determination will occur during any future Site Improvement Plan for development of the property.
Douglas County Water Commission	02/23/2026	No Comment.	No action necessary.
Engineering Services	03/03/2026	No Comment.	No action necessary.
High Line Canal Conservancy		No Response Received.	No action necessary.
Highlands Ranch Community Association	02/11/2026	<p>Received (verbatim response):</p> <p>HRCA appreciates the opportunity to review and opine on this application. We have reviewed the applicant's revised Planned Development amendment (ZR2026-002), which proposes to add 350 residential dwelling units within Planning Area 85 of the Highlands Ranch Planned Development (HRPD). In 2025, HRCA reviewed a substantially similar request involving approximately 400 units and communicated that it took no exceptions to the amendment.</p> <p>The current submittal reflects a reduction in total dwelling units (350 vs. 400), clarifies the residential product mix, and includes additional documentation related to infrastructure capacity and traffic mitigation measures. The proposal does not introduce a new land use, expand the development footprint beyond Planning Area 85, or increase overall development intensity beyond what HRCA previously reviewed.</p> <p>Based on this review, HRCA takes No Exceptions to the proposed 84th Amendment (ZR2026-002).</p> <p>We take this opportunity to remind the applicant that a formal submittal, made directly to HRCA, for review (via our Development Review Committee, DRC) of the SITE IMPROVEMENT PLAN, is required when this project moves into that phase.</p>	No action necessary.

**Referral Agency Response Report**

**Project Name:** Highlands Ranch Planned Development, 84th Amendment

**Project File #:** ZR2026-002

**Date Sent:** 02/10/2026

**Date Due:** 03/03/2026

Agency	Date Received	Agency Response	Response Resolution
Highlands Ranch Golf Club HOA		No Response Received.	No action necessary.
Highlands Ranch Metro District	02/26/2026	Following is an excerpt of the referral comments from Highlands Ranch Metro District (HRMD). See the full letter for detail.  No comments.	No action necessary.
Highlands Ranch Water and Sanitation District	02/26/2026	Following is a summary of the referral comments received from Highlands Ranch Water and Sanitation. See the full letter for detail.  Site, civil, architectural and MEP plans must be submitted for review and approval.  Contact the Financial Analyst for required fees.	Applicant will comply with all requirements to receive service from HR Water and at time of development of the project site.
Jefferson County Planning and Zoning	02/12/2026	Received (verbatim response): There are no comments from Jefferson County Planning and Zoning.	No action necessary.
Littleton - Planning	02/13/2026	Following is an excerpt of comments received from the City of Littleton:  No comments	No action necessary.
Littleton - Engineering	03/03/2026	Following is a summary of referral comments from the City of Littleton Engineering Staff. See full letter for detail.  Littleton Engineering requests that the intersection of Erickson Boulevard and County Line Road be included in the traffic study so Littleton can confirm that intersection has capacity to accommodate peak hour traffic.	Applicant's traffic study has been accepted by County Engineering for purposes of the proposed PD Amendment. Applicant has communicated with Littleton Engineering to discuss the proposal. However, the site is approximately 1 mile from the intersection of Erickson Boulevard and County Line Road and potential impacts to this intersection are not anticipated.

**Referral Agency Response Report****Project Name:** Highlands Ranch Planned Development, 84th Amendment**Project File #:** ZR2026-002**Date Sent:** 02/10/2026**Date Due:** 03/03/2026

<b>Agency</b>	<b>Date Received</b>	<b>Agency Response</b>	<b>Response Resolution</b>
Mile High Flood District	03/10/2026	Following is a summary of the referral comments received from Mile High Flood District. See full letter for detail.  No comments and do not need to see future submittals.	No action necessary.
Office of Emergency Management	02/23/2026	No Comment.	No action necessary.
RTD - Planning & Development Dept	03/02/2026	Following is a summary of comments received from RTD. See full letter for detail.  No exceptions from any departments.	No action necessary.
Sheriff's Office		No Response Received.	No action necessary.
Sheriff's Office E911		No Response Received.	No action necessary.
South Metro Fire Rescue	02/17/2026	Received (verbatim response): South Metro Fire Rescue (SMFR) has reviewed the provided documents and has no objection to the proposed Major Planned Development Amendment.	No action necessary.
Xcel Energy-Right of Way & Permits	02/23/2026	Following is a summary of referral comments from Xcel Energy. See the full letter for detail.  Xcel requested a note be included on future plat documents. Xcel also indicated the presence of a high-pressure natural gas line on the south side of one of the subject parcels. Any encroachments, grading, landscaping, or similar activities will require Xcel approval and a license agreement.	Applicant will comply with all requirements to receive service from Xcel Energy. The requested note is not applicable to the PD Amendment process. The location of utilities and any potential new easements will be determined as part of future development of the site.

**From:** annb cwc64.com  
**Sent:** Thursday, February 12, 2026 11:27 AM  
**To:** Matt Jakubowski  
**CC:** LANA SCARLETT-ROWELL (ls1762@att.com); duanew cwc64.com; jt cwc64.com  
**Subject:** Ben Franklin Highlands Ranch, Colorado Douglas County eReferral #ZR2026-002  
**Attachments:** Ben Franklin Highlands Ranch, Colorado.jpg

Caution: This email originated outside the organization. Be cautious with links and attachments.

Hi Matt,

This is in response to your eReferral with a utility map showing any buried AT&T Long Line Fiber Optics near Ben Franklin Highlands Ranch, Colorado. The Earth map shows the project area in red. Based on the address and/or map you provided, there should be NO conflicts with the AT&T Long Lines, as we do not have facilities in that area.

Please feel free to contact us with any questions or concerns.

Ann Barnowski  
Clearwater Consulting Group Inc  
120 9th Avenue South  
Suite 140  
Nampa, ID 83651  
Annb@cwc64.com

The attached google earth maps are intended to show approximate locations of the buried AT&T long line fiber optic cable. The maps are provided for informational purposes only. In no way should the maps be used for anything other than general guidelines as to where the fiber is or is not and any other use of these maps is strictly prohibited.

-----Original Message-----

From: mjakubow@douglas.co.us <mjakubow@douglas.co.us>  
Sent: Tuesday, February 10, 2026 2:55 PM  
To: annb cwc64.com <annb@cwc64.com>  
Subject: Douglas County eReferral (ZR2026-002) Is Ready For Review

There is an eReferral for your review. Please use the following link to log on to your account:  
<https://apps.douglas.co.us/planning/projects/Login.aspx>

Project Name: Highlands Ranch Planned Development, 84th Amendment  
Project File #: ZR2026-002

Project Summary: Applicant, Pagewest Acquisitions, is requesting a Major Planned Development (PD) amendment to the Highlands Ranch PD to add 350 residential units to PA 85. Although one-family attached, two-family, and multifamily dwelling units are allowed uses in PA 85 by right, additional units must be assigned to develop such uses. The applicant ultimately proposes multifamily and townhouse development on the two subject parcels (4.61 acres & 10.2 acres). The parcels are located on the north side of Plaza Drive at Plaza Circle, approximately ½ mile west of the intersection of Kendrick Castillo Way and Plaza Drive. Future development on the property requires separate Site Improvement Plan approval, not subject of this application.

This referral will close on Tuesday, March 3, 2026.

If you have any questions, please contact me.

Sincerely,

Matt Jakubowski, AICP | Chief Planner  
Douglas County Department of Community Development Planning Services Division Address | 100 Third St., Castle Rock, CO 80104  
Phone | 303-660-7460 Email | mjakubow@douglas.co.us



**From:** Loeffler - CDOT, Steven  
**Sent:** Thursday, February 12, 2026 8:07 AM  
**To:** Matt Jakubowski  
**CC:** Jessica Varner - CDOT; Joseph Tripple - CDOT  
**Subject:** Re: Douglas County eReferral (ZR2026-002) Is Ready For Review

**Caution:** This email originated outside the organization. Be cautious with links and attachments.

Matt,

I have reviewed the referral for Highlands Ranch Planned Development, 84th Amendment with PD to add 350 residential units to PA 85 and have the following comments.

- Due to the proximity of this development to the C470 EB ramp we would like to review the drainage report to confirm no negative impact.
- Any signing for this development visible to the state highway must be compliant with the state rules for outdoor advertising per 2 CCR 601-3.
- We ask that the county continue to monitor cumulative impact of development on the Kendrick Castillo Way and C470 interchange.

Thank you for the opportunity to review this referral.

**Steve Loeffler**  
Permits Unit- Region 1



P 303.757.9891 | F 303.757.9053  
2829 W. Howard Pl. 2nd Floor, Denver, CO 80204  
[steven.loeffler@state.co.us](mailto:steven.loeffler@state.co.us) | [www.codot.gov](http://www.codot.gov) | [www.cotrip.org](http://www.cotrip.org)



On Tue, Feb 10, 2026 at 2:56 PM <[mjakubow@douglas.co.us](mailto:mjakubow@douglas.co.us)> wrote:

There is an eReferral for your review. Please use the following link to log on to your account:

[https://urldefense.com/v3/https://apps.douglas.co.us/planning/projects/Login.aspx;!!PUG2raq7KiCZwBk!ePIT9Q8X\\_BY9BPtIbsQ46wMIiby6WJg-r-0iT7T9TXA1vmGtTDXyKV0\\_2Uyu0WEdok2I4ZKOkbZLsrAHEQrN9l6HiNeE\\$](https://urldefense.com/v3/https://apps.douglas.co.us/planning/projects/Login.aspx;!!PUG2raq7KiCZwBk!ePIT9Q8X_BY9BPtIbsQ46wMIiby6WJg-r-0iT7T9TXA1vmGtTDXyKV0_2Uyu0WEdok2I4ZKOkbZLsrAHEQrN9l6HiNeE$)

Project Name: Highlands Ranch Planned Development, 84th Amendment

Project File #: ZR2026-002

Project Summary: Applicant, Pagewest Acquisitions, is requesting a Major Planned Development (PD) amendment to the Highlands Ranch PD to add 350 residential units to PA 85. Although one-family attached,

two-family, and multifamily dwelling units are allowed uses in PA 85 by right, additional units must be assigned to develop such uses. The applicant ultimately proposes multifamily and townhouse development on the two subject parcels (4.61 acres & 10.2 acres). The parcels are located on the north side of Plaza Drive at Plaza Circle, approximately 1/2 mile west of the intersection of Kendrick Castillo Way and Plaza Drive. Future development on the property requires separate Site Improvement Plan approval, not subject of this application.

This referral will close on Tuesday, March 3, 2026.

If you have any questions, please contact me.

Sincerely,

Matt Jakubowski, AICP | Chief Planner  
Douglas County Department of Community Development  
Planning Services Division  
Address | 100 Third St., Castle Rock, CO 80104  
Phone | 303-660-7460  
Email | [mjakubow@douglas.co.us](mailto:mjakubow@douglas.co.us)



March 3, 2026

Matt Jakubowski  
303-660-7460  
email: [mjakubow@douglas.co.us](mailto:mjakubow@douglas.co.us)

RE: Douglas County eReferral (ZR2026-002)

Matt,

This letter comes in response to your request for a review for:

**Proposed Highlands Ranch Planned Development, 80th Amendment**

City of Littleton engineering staff have reviewed the referral request for a Major Planned Development amendment, which proposes additional units to the permitted uses within Planning Area 85. We have a comment concerning the Lucent Station Traffic Impact Study.

Staff acknowledges that the intersection of Erickson Blvd and Plaza Dr (#1) is included in the study. However, we request that the intersection of Erickson Blvd and County Line Rd intersection be included. Per Figure 7, Project Traffic Assignment, Intersection #1 is projected to have 37 AM peak hour trips and 24 PM peak hour trips making the WB right turn onto NB Erickson Blvd. We would like to confirm that the intersection of Erickson Blvd and County Line Rd, owned and operated by the City of Littleton, has sufficient storage and capacity to accommodate the anticipated peak hour traffic, which we assume will involve vehicles making a NB left turn onto WB County Line Rd to access Santa Fe.

Please reach out with any additional questions or comments.

Thank you,

A handwritten signature in black ink, appearing to read "J Stemley".

**Jessica Stemley**  
Development  
Engineering Manager  
[jstemley@littletonco.gov](mailto:jstemley@littletonco.gov)  
303.795.3868



February 13, 2026

Matt Jakubowski  
(303)814-4324  
email: [mjakubow@douglas.co.us](mailto:mjakubow@douglas.co.us)

RE: Highlands Ranch Planned Development, 84th Amendment, ZR2026-002

Matt,

This letter comes in response to your request for a review for:

**Highlands Ranch Planned Development, 84th Amendment, ZR2026-002**

City of Littleton planning staff have reviewed the above referral request and have **no comments**.

Thank you,

**Rachel Vigil**

Community Development

Planner I

[rvigil@littletonco.gov](mailto:rvigil@littletonco.gov)

303.795.3721

**From:** Matz - DNR, Michael  
**Sent:** Monday, March 9, 2026 12:08 PM  
**To:** Matt Jakubowski  
**CC:** Javier Vargas-Johnson - DNR  
**Subject:** Re: Douglas County eReferral (ZR2026-002) Is Ready For Review

**Caution:** This email originated outside the organization. Be cautious with links and attachments.

Good afternoon,

We have received Referral ZR2026-002 regarding a proposal to add 350 residential units to planning area 85 inside the Highlands Ranch Subdivision.

This referral does not appear to qualify as a “subdivision” as defined in section 30-28-101(10)(a), C.R.S. Therefore, pursuant to the State Engineer’s March 4, 2005 and March 11, 2011 memorandums to county planning directors, this office will only perform a cursory review of the referral information and provide informal comments. The comments do not address the adequacy of the water supply plan for this project or the ability of the water supply plan to satisfy any County regulations or requirements. In addition, the comments provided herein cannot be used to guarantee a viable water supply plan or infrastructure, the issuance of a well permit, or physical availability of water.

A review of our records indicates there are no production wells on the two subject parcels.

The proposed water source for the multifamily and townhouse dwellings on the two parcels is service through the Highlands Ranch Water District. A will-serve letter indicating the District's willingness to serve the proposed development was included in the referral documents. Our office has no comments regarding this referral.

Thank you for the opportunity to review.

Best,

Mike Matz, P.E.  
Water Resources Engineer



P 303.866.3581 x 8241  
1313 Sherman Street, Room 821, Denver, CO 80203  
[michael.matz@state.co.us](mailto:michael.matz@state.co.us) | [www.colorado.gov/water](http://www.colorado.gov/water)

On Thu, Feb 12, 2026 at 12:17 PM Matt Jakubowski <[mjakubow@douglas.co.us](mailto:mjakubow@douglas.co.us)> wrote:

Hi Mike,

This is not a subdivision action. The proposal is a zoning amendment to assign 350 units to a Planning Area within the Highlands Ranch Planned Development. A future Site Plan will follow for the specific design of the site. Referrals will be sent for the Site Plan process as well.

Matt

**Matt Jakubowski, AICP** | Chief Planner

**Douglas County Department of Community Development**

**Planning Services Division**

**Address** | 100 Third St., Castle Rock, CO 80104

**Phone** | 303-660-7460

**Email** | [mjakubow@douglas.co.us](mailto:mjakubow@douglas.co.us)

**NOTICE:** Douglas County Planning does not charge "Approval" fees. Douglas County communicates through our official email accounts ending in [@douglas.co.us](mailto:@douglas.co.us); beware of phishing scams using similar addresses. If you have questions or concerns about the validity of an email or invoice, please call our Public Outreach and Assistance team at 303-660-7460 or email [planning@douglas.co.us](mailto:planning@douglas.co.us).

---

**From:** Matz - DNR, Michael <[michael.matz@state.co.us](mailto:michael.matz@state.co.us)>

**Sent:** Thursday, February 12, 2026 9:09 AM

**To:** Matt Jakubowski <[mjakubow@douglas.co.us](mailto:mjakubow@douglas.co.us)>

**Subject:** Fwd: Douglas County eReferral (ZR2026-002) Is Ready For Review

**Caution:** This email originated outside the organization. Be cautious with links and attachments.

Good morning,

We just wanted to see if the County was considering this amendment to the Highlands Ranch PD as a subdivision action? Or would the County consider it a non-subdivision action?

Thanks,

Mike Matz, P.E.  
Water Resources Engineer



P 303.866.3581 x 8241  
1313 Sherman Street, Room 821, Denver, CO 80203  
[michael.matz@state.co.us](mailto:michael.matz@state.co.us) | [www.colorado.gov/water](http://www.colorado.gov/water)

----- Forwarded message -----

**From: Vargas-Johnson - DNR, Javier** <[javier.vargasjohnson@state.co.us](mailto:javier.vargasjohnson@state.co.us)>  
**Date:** Wed, Feb 11, 2026 at 4:16 PM  
**Subject:** Fwd: Douglas County eReferral (ZR2026-002) Is Ready For Review  
**To:** Michael Matz - DNR <[michael.matz@state.co.us](mailto:michael.matz@state.co.us)>

Hi Mike,

Please see this referral for a Major Planned Development. Please note that this may meet the definition of a subdivision as stated in 30-28-101(10)(a) : " **”Subdivision“ or ”subdivided land“** means any parcel of land in the state which is to be used for condominiums, apartments, or any other multiple-dwelling units, unless such land when previously subdivided was accompanied by a filing which complied with the provisions of this part 1 with substantially the same density, or which is divided into two or more parcels, separate interests, or interests in common, unless exempted under paragraph (b), (c), or (d) of this subsection (10). As used in this section, **”interests“ includes any and all interests in the surface of land but excludes any and all subsurface interests.**"

Javier Vargas-Johnson, P.E.  
Chief of Water Supply, Designated Basins



P 303-866-3581 x8265  
1313 Sherman Street, Room 821, Denver, CO 80203  
[javier.vargasjohnson@state.co.us](mailto:javier.vargasjohnson@state.co.us) | <https://dwr.colorado.gov/>

----- Forwarded message -----

From: <[mjakubow@douglas.co.us](mailto:mjakubow@douglas.co.us)>

Date: Tue, Feb 10, 2026 at 2:56 PM

Subject: Douglas County eReferral (ZR2026-002) Is Ready For Review

To: <[javier.vargasjohnson@state.co.us](mailto:javier.vargasjohnson@state.co.us)>

There is an eReferral for your review. Please use the following link to log on to your account:

[https://urldefense.com/v3/https://apps.douglas.co.us/planning/projects/Login.aspx;!!PUG2raq7KiCZwBk!cVyGJ1LV4H7Pc9Df4VnIwVG6FK-vsevsMl-ZFj5bJopvS0C2ot3gMdCI2NHH-Wp1lcpikh4aIjWJo3hZU3SV9Phjl7s8m19y\\$](https://urldefense.com/v3/https://apps.douglas.co.us/planning/projects/Login.aspx;!!PUG2raq7KiCZwBk!cVyGJ1LV4H7Pc9Df4VnIwVG6FK-vsevsMl-ZFj5bJopvS0C2ot3gMdCI2NHH-Wp1lcpikh4aIjWJo3hZU3SV9Phjl7s8m19y$)

Project Name: Highlands Ranch Planned Development, 84th Amendment

Project File #: ZR2026-002

Project Summary: Applicant, Pagewest Acquisitions, is requesting a Major Planned Development (PD) amendment to the Highlands Ranch PD to add 350 residential units to PA 85. Although one-family attached, two-family, and multifamily dwelling units are allowed uses in PA 85 by right, additional units must be assigned to develop such uses. The applicant ultimately proposes multifamily and townhouse development on the two subject parcels (4.61 acres & 10.2 acres). The parcels are located on the north side of Plaza Drive at Plaza Circle, approximately " mile west of the intersection of Kendrick Castillo Way and Plaza Drive. Future development on the property requires separate Site Improvement Plan approval, not subject of this application.

This referral will close on Tuesday, March 3, 2026.

If you have any questions, please contact me.

Sincerely,

Matt Jakubowski, AICP | Chief Planner  
Douglas County Department of Community Development  
Planning Services Division  
Address | 100 Third St., Castle Rock, CO 80104  
Phone | 303-660-7460  
Email | [mjakubow@douglas.co.us](mailto:mjakubow@douglas.co.us)

DV 26-120



www.douglas.co.us

Department of Community Development  
Planning Services

**REFERRAL RESPONSE REQUEST – MAJOR PLANNED DEVEL. AMD.**

Date sent: February 10, 2026

Comments due by: **March 3, 2026**

Fax: 303.660.9550

**Project Name:** Highlands Ranch Planned Development, 84<sup>th</sup> Amendment

**Project File #:** ZR2026-002

**Project Summary:**

Applicant, Pagewest Acquisitions, is requesting a Major Planned Development (PD) amendment to the Highlands Ranch PD to add 350 residential units to PA 85. Although one-family attached, two-family, and multifamily dwelling units are allowed uses in PA 85 by right, additional units must be assigned to develop such uses. The applicant ultimately proposes multifamily and townhouse development on the two subject parcels (4.61 acres & 10.2 acres). The parcels are located on the north side of Plaza Drive at Plaza Circle, approximately 1/2 mile west of the intersection of Kendrick Castillo Way and Plaza Drive. Future development on the property requires separate Site Improvement Plan approval, not subject of this application.

Information on the identified development proposal located in Douglas County is enclosed. Please review and comment in the space provided.

<input checked="" type="checkbox"/> No Comment
<input type="checkbox"/> Please be advised of the following concerns: _____ _____
<input type="checkbox"/> See letter attached for detail.
Agency: <u>ENGINEERING</u> Phone #: <u>4318</u>
Your Name: <u>AL PETERSON</u> Your Signature: <u>Al Peterson</u> (please print)
Date: <u>3/3/2026</u>

Agencies should be advised that failure to submit written comments prior to the due date, or to obtain the applicant's written approval of an extension, will result in written comments being accepted for informational purposes only.

Sincerely,

*Matt Jakubowski*  
Matt Jakubowski, Chief Planner  
Enclosure

100 Third Street, Castle Rock, Colorado 80104 • 303.660.7460



620 Wilcox Street  
Castle Rock, Colorado 80104

March 9, 2026

Matt Jakubowski, AICP | Chief Planner  
Douglas County Department of Community Development  
Planning Services Division  
Address | 100 Third St., Castle Rock, CO 80104  
Phone | 303-660-7460  
Email | [mjakubow@douglas.co.us](mailto:mjakubow@douglas.co.us)

RE: Highlands Ranch Planned Development Major Amendment-84th Amendment  
(ZR2026-002)

Mr. Jakubowski,

It is our understanding that the applicant has requested a Major Amendment to Planning Area 85 of the Highlands Ranch Planned Development to allow for additional residential units. It is also our understanding that the application proposes the addition of 350 residential units to the PD bringing the total allowed dwelling units in the Highlands Ranch PD from 36,068 to 36,418. Finally, it's our understanding that multifamily and townhouse development on two existing parcels totalling approximately 14.8-acres is being proposed. The proposed development is located directly northwest of the Children's Hospital Colorado South Campus at the intersection of Plaza Drive and Kendrick Castillo Way.

DCSD has calculated the amount of school site land requirement for students generated by the proposed planned development (as per the attached conceptual plan). Student generation and the associated land dedication requirement are shown below. A total of 18 elementary school students, 3 middle school students, and 6 high school students are expected from the development (as proposed) generating a land dedication requirement of 0.578-acres. Since this is smaller than DCSD's minimum school site size, DCSD would request cash-in-lieu of land dedication.

**CASH-IN-LIEU CALCULATION  
STUDENT GENERATION**

<b>PROJECT NAME: Highlands Ranch PD 84th Amendment (ZR2026-002)</b>				
<b>DU/ 350</b>	<b>ACRES 14.81</b>		<b>DENSITY 23.63</b>	
			<b>Generation</b>	<b>Number</b>
<b><u>STUDENT GENERATION RATES</u></b>	<b><u>No. of DU's</u></b>		<b><u>Rate</u></b>	<b><u>of Students</u></b>
<b>ELEMENTARY</b>	<b>350</b>	<b>X</b>	<b>0.05</b>	<b>18</b>
<b>MIDDLE SCHOOL</b>	<b>350</b>	<b>X</b>	<b>0.008</b>	<b>3</b>
<b>HIGH SCHOOL</b>	<b>350</b>	<b>X</b>	<b>0.017</b>	<b>6</b>
				<b>26</b>
				<b>Required</b>
			<b>School</b>	<b>Land</b>
	<b>Number</b>		<b>Acreage</b>	<b>Dedication</b>
<b><u>SCHOOL LAND DEDICATION</u></b>	<b><u>of Students</u></b>		<b><u>Per Student</u></b>	<b><u>Acreage</u></b>
<b>ELEMENTARY</b>	<b>18</b>	<b>X</b>	<b>0.018</b>	<b>0.315</b>
<b>MIDDLE SCHOOL</b>	<b>3</b>	<b>X</b>	<b>0.030</b>	<b>0.084</b>
<b>HIGH SCHOOL</b>	<b>6</b>	<b>X</b>	<b>0.030</b>	<b>0.179</b>
			<b>TOTAL</b>	<b>0.578</b>

As per Article 1004.05.3 of the Douglas County Subdivision Regulations, "The cash-in-lieu fee shall be equivalent to the full market value of the acreage required for school land dedication. Value shall be based on anticipated market value after completion of platting. The applicant shall submit a proposal for the cash-in-lieu fee and supply the information necessary for the Board to evaluate the adequacy of the proposal. This information shall include at least one appraisal of the property by a qualified appraiser."

DCSD would ask that the required cash-in-lieu fee be paid directly to the School District upon Site Plan approval.

Granted the applicant and Douglas County agrees to this request, DCSD has no objection to the proposed PD Major Amendment.

Shavon Caldwell, Planning Manager  
DCSD Planning & Construction  
[scaldwell2l@dcsdk12.org](mailto:scaldwell2l@dcsdk12.org)  
desk: 303.387.0417



February 26, 2026

Carolyn Washee-Freeland, AICP, Senior Planner  
Douglas County Department of Community Development, Planning Services  
100 Third Street  
Castle Rock, CO 80104

Project name: Highlands Ranch Planned Development 84<sup>th</sup> Amendment - Apartments

Project File #: ZR2026-002

Review Date: March 3, 2026

Project Summary: Requesting a Major Planned Development (PD) amendment to the Highlands Ranch PD to add 350 residential units to PA 85. Although one-family attached, two-family, and multifamily dwelling units are allowed uses in PA 85 by right, additional units must be assigned to develop such uses. The applicant ultimately proposes multifamily and townhouse development on the two subject parcels (4.61 acres & 10.2 acres).

The District appreciated the opportunity to review and comment on the proposed project. District staff have reviewed the proposed application for its impacts on our facilities and offers no comments.



February 26, 2026

Carolyn Washee-Freeland, AICP, Senior Planner  
Douglas County Department of Community Development, Planning Services  
100 Third Street  
Castle Rock, CO 80104

Project name: Highlands Ranch Planned Development 84<sup>th</sup> Amendment - Apartments

Project File #: ZR2026-002

Review Date: March 3, 2026

Project Summary: Requesting a Major Planned Development (PD) amendment to the Highlands Ranch PD to add 350 residential units to PA 85. Although one-family attached, two-family, and multifamily dwelling units are allowed uses in PA 85 by right, additional units must be assigned to develop such uses. The applicant ultimately proposes multifamily and townhouse development on the two subject parcels (4.61 acres & 10.2 acres).

The District appreciated the opportunity to review and comment on the proposed project. District staff has reviewed the proposed application for its impacts on our facilities and offers the following comments:

- Site civil, architectural and MEP plans must be submitted to the District for review and approval.

Jon Klassen  
Project Manager

- Contact our Financial Analyst to acquire system development and tap fees quotes. 303-791-0430

**From:** Lindsey Wire  
**Sent:** Thursday, February 12, 2026 9:26 AM  
**To:** Matt Jakubowski; Referrals  
**Subject:** Re: --{EXTERNAL}-- Douglas County eReferral (ZR2026-002) Is Ready For Review

**Caution:** This email originated outside the organization. Be cautious with links and attachments.

Hello,

Thank you for the referral.

There are no comments from Jefferson County Planning and Zoning.

Thank you,

**Lindsey Wire** (she/her)  
Engineering Supervisor  
Planning & Zoning  
o 303-271-8717  
[lwire@jeffco.us](mailto:lwire@jeffco.us) | [planning.jeffco.us](http://planning.jeffco.us)



Help us shape the future of Jefferson County by visiting the Together Jeffco website!  
<https://togetherjeffco.com>

---

**From:** [mjakubow@douglas.co.us](mailto:mjakubow@douglas.co.us) <[mjakubow@douglas.co.us](mailto:mjakubow@douglas.co.us)>  
**Sent:** Tuesday, February 10, 2026 2:54 PM  
**To:** Referrals <[Referrals@co.jefferson.co.us](mailto:Referrals@co.jefferson.co.us)>  
**Subject:** --{EXTERNAL}-- Douglas County eReferral (ZR2026-002) Is Ready For Review

There is an eReferral for your review. Please use the following link to log on to your account:  
[https://urldefense.com/v3/https://apps.douglas.co.us/planning/projects/Login.aspx;!!AimZMsSgOA4!vjoExtWG5qu7JA4oXxJu7vo9SU4KDnJ4WCL2GSEzbYTVyGyOeanvsV8Aw1EkKjvWPXgKQ6TChFjUPxGGYZ39q6HaxiYcTg\\$\[apps\[.\]douglas\[.\]co\[.\]us](https://urldefense.com/v3/https://apps.douglas.co.us/planning/projects/Login.aspx;!!AimZMsSgOA4!vjoExtWG5qu7JA4oXxJu7vo9SU4KDnJ4WCL2GSEzbYTVyGyOeanvsV8Aw1EkKjvWPXgKQ6TChFjUPxGGYZ39q6HaxiYcTg$[apps[.]douglas[.]co[.]us)

**Project Name:** Highlands Ranch Planned Development, 84th Amendment  
**Project File #:** ZR2026-002  
**Project Summary:** Applicant, Pagewest Acquisitions, is requesting a Major Planned Development (PD) amendment to the Highlands Ranch PD to add 350 residential units to PA 85. Although one-family attached, two-family, and multifamily dwelling units are allowed uses in PA 85 by right, additional units must be assigned to develop such uses. The applicant ultimately proposes multifamily and townhouse development on the two subject parcels (4.61 acres & 10.2 acres). The parcels are located on the north side of Plaza Drive at Plaza Circle, approximately ½ mile west of the intersection of Kendrick Castillo Way and Plaza Drive. Future development on the property requires separate Site Improvement Plan approval, not subject of this application.

This referral will close on Tuesday, March 3, 2026.

If you have any questions, please contact me.

Sincerely,

Matt Jakubowski, AICP | Chief Planner  
Douglas County Department of Community Development  
Planning Services Division  
Address | 100 Third St., Castle Rock, CO 80104  
Phone | 303-660-7460  
Email | [mjakubow@douglas.co.us](mailto:mjakubow@douglas.co.us)

March 10, 2026

For MHFD staff use only.	
Project ID:	106664
Submittal ID:	10014037

**To:** Douglas County  
*Via email*

**Subject:** MHFD Review Comments

**Re:** Highlands Ranch Planned Development 84<sup>th</sup> Amendment (Partner Case No. ZR2026-002)

This letter is in response to the request for our comments concerning the referenced project. We have reviewed this referral only as it relates to an MHFD drainageway and for maintenance eligibility of storm drainage features, in this case:

- Outfall to Marcy Gulch
- Outfall to Dad Clark Gulch

We have no comments to the referenced project and do not need to see future submittals.

Please feel free to contact me with any questions.

Sincerely,

**Laura Hinds, P.E.**  
Project Manager, Mile High Flood District  
[lhinds@mhfd.org](mailto:lhinds@mhfd.org)

**From:** Clayton Woodruff  
**Sent:** Monday, March 2, 2026 2:31 PM  
**To:** Matt Jakubowski  
**Subject:** RE: Douglas County eReferral (ZR2026-002) Is Ready For Review

Caution: This email originated outside the organization. Be cautious with links and attachments.

#### RTD Comments

Project Name: Highlands Ranch Planned Development, 84th Amendment - ZR2026-002 - 1st Submittal

Department	Comments
Bus Operations	No exceptions
Bus Stop Program	No exceptions
Commuter Rail	No exceptions
Construction Management	No exceptions
Engineering	No exceptions
Light Rail	No exceptions
Real Property	No exceptions
Service Development	No exceptions
Transit Oriented Development	No exceptions
Utilities	No exceptions

This review is for Design concepts and to identify any necessary improvements to RTD stops and property affected by the design. This review of the plans does not eliminate the need to acquire, and/or go through the acquisition process of any agreements, easements or permits that may be required by the RTD for any work on or around our facilities and property.

C Scott Woodruff  
Engineer III  
Capital Programs  
o. 303.299.2943  
m. 303-720-2025  
Clayton.woodruff@rtd-denver.com  
rtd-denver.com

Regional Transportation District  
1560 Broadway, Suite 700, FAS-72  
Denver, CO 80202

We make lives better through connections.

-----Original Message-----

From: mjakubow@douglas.co.us <mjakubow@douglas.co.us>  
Sent: Tuesday, February 10, 2026 2:55 PM  
To: Engineering <engineering@RTD-Denver.com>  
Subject: Douglas County eReferral (ZR2026-002) Is Ready For Review

There is an eReferral for your review. Please use the following link to log on to your account:

<https://apps.douglas.co.us/planning/projects/Login.aspx>

Project Name: Highlands Ranch Planned Development, 84th Amendment  
Project File #: ZR2026-002

Project Summary: Applicant, Pagewest Acquisitions, is requesting a Major Planned Development (PD) amendment to the Highlands Ranch PD to add 350 residential units to PA 85. Although one-family attached, two-family, and multifamily dwelling units are allowed uses in PA 85 by right, additional units must be assigned to develop such uses. The applicant ultimately proposes multifamily and townhouse development on the two subject parcels (4.61 acres & 10.2 acres). The parcels are located on the north side of Plaza Drive at Plaza Circle, approximately ½ mile west of the intersection of Kendrick Castillo Way and Plaza Drive. Future development on the property requires separate Site Improvement Plan approval, not subject of this application.

This referral will close on Tuesday, March 3, 2026.

If you have any questions, please contact me.

Sincerely,

Matt Jakubowski, AICP | Chief Planner

Douglas County Department of Community Development Planning Services Division Address | 100 Third St., Castle Rock, CO 80104

Phone | 303-660-7460 Email | [mjakubow@douglas.co.us](mailto:mjakubow@douglas.co.us)

# SOUTH METRO FIRE RESCUE FIRE MARSHAL'S OFFICE

---



Matthew Jakubowski, AICP, Chief Planner  
Douglas County Department of Community Development, Planning Services  
100 Third St  
Castle Rock Co 80104  
303.660.7460  
303.660.9550 Fax

Project Name: Highlands Ranch Planned Development, 84th Amendment  
Project File #: **ZR2026-002**  
S Metro Review #: REFPDP26-00047

Review date: February 17, 2026

Plan reviewer: Aaron Miller  
720.989.2246  
[aaron.miller@southmetro.org](mailto:aaron.miller@southmetro.org)

**Project Summary:** Applicant, Pagewest Acquisitions, is requesting a Major Planned Development (PD) amendment to the Highlands Ranch PD to add 350 residential units to PA 85. Although one-family attached, two-family, and multifamily dwelling units are allowed uses in PA 85 by right, additional units must be assigned to develop such uses. The applicant ultimately proposes multifamily and townhouse development on the two subject parcels (4.61 acres & 10.2 acres). The parcels are located on the north side of Plaza Drive at Plaza Circle, approximately ½ mile west of the intersection of Kendrick Castillo Way and Plaza Drive. Future development on the property requires separate Site Improvement Plan approval, not subject of this application.

Code Reference: Douglas County Fire Code, 2018 International Fire Code, and 2021 International Building Code with amendments as adopted by Douglas County.

South Metro Fire Rescue (SMFR) has reviewed the provided documents and has no objection to the proposed Major Planned Development Amendment.



**Right of Way & Permits**

1123 West 3<sup>rd</sup> Avenue  
Denver, Colorado 80223  
Telephone: 303.285.6612  
violeta.ciocanu@xcelenergy.com

February 23, 2026

Douglas County Planning Services  
100 Third Street  
Castle Rock, CO 80104

Attn: Matt Jakubowski

**Re: Highlands Ranch Planned Development, 84th Amendment, Case # ZR2026-002**

Public Service Company of Colorado's (PSCo) Right of Way and Permits Referral Desk has reviewed the above-mentioned application. As always, thank you for the opportunity to take part in the review process.

In the future, for these *multi-family apartment-type* lots, and to ensure that adequate utility easements are available within this development and per state statutes §31-23-214 (3) and 30-28-133(e), PSCo requests that the following language or plat note be placed on the preliminary and final plats for the subdivision:

*Minimum 10-foot-wide dry utility easements are hereby dedicated on private property abutting all public streets, and around the perimeter of each lot or platted area including tracts, parcels and/or open space areas. These easements are dedicated to the County of Douglas for the benefit of the applicable utility providers for the installation, maintenance, and replacement of electric, gas, television, cable, and telecommunications facilities (Dry Utilities). Utility easements shall also be granted within any access easements and private streets in the subdivision. Permanent structures, improvements, objects, buildings, wells, water meters and other objects that may interfere with the utility facilities or use thereof (Interfering Objects) shall not be permitted within said utility easements and the utility providers, as grantees, may remove any Interfering Objects at no cost to such grantees, including, without limitation, vegetation. Public Service Company of Colorado (PSCo) and its successors reserve the right to require additional easements and to require the property owner to grant PSCo an easement on its standard form.*

Also, Public Service Company has an existing high-pressure natural gas *transmission* pipeline along the south property line of parcel 2. Any activity including grading, proposed landscaping, erosion control or similar activities involving our existing right-of-way will require Public Service Company approval. Encroachments across Public Service Company's easements must be reviewed for safety standards, operational and maintenance clearances, liability issues, and

acknowledged with a Public Service Company License Agreement to be executed with the property owner. PSCo is requesting that, prior to any final approval of the development plan, it is the responsibility of the property owner/developer/contractor to contact PSCo's Encroachment Team for development plan review and execution of a License Agreement (upload all files in PDF format) at: [cloud.marketing.xcelenergy.com/encroachment](https://cloud.marketing.xcelenergy.com/encroachment).

The property owner/developer/contractor must complete the application process for any new natural gas or electric service, or modification to existing facilities via [Building and Remodeling | Partner Resources | Xcel Energy](#). It is then the responsibility of the developer to contact the Xcel Designer assigned to the project for approval of design details.

Additional easements may need to be acquired by separate document. The Designer must contact the appropriate Right-of-Way Agent.

As a safety precaution, PSCo would like to remind the developer to contact Colorado 811 for utility locates prior to construction.

Violeta Ciocanu (Chokanu)  
Right of Way and Permits  
Public Service Company of Colorado dba Xcel Energy  
Office: 303-285-6612 – Email: [violeta.ciocanu@xcelenergy.com](mailto:violeta.ciocanu@xcelenergy.com)

*Although “branded” as Xcel Energy, the legal owner and operator of the utility facilities in Colorado is Public Service Company of Colorado. All utility facilities and related land rights, including fee property, easements, permits, etc., are owned by, operated by and held in the name of Public Service Company of Colorado, a Colorado Corporation.*



March 23, 2026

Matt Jakubowski  
Department of Community Development  
100 Third Street  
Castle Rock, CO 80104

**Re: Highlands Ranch Planned Development, 80th Amendment (ZR2025-001) – Response to 1st Review Comments**

Dear Mr. Jakubowski,

Thank you for your comments for the initial review of a PD Major Amendment to the Highlands Ranch Planned Development to develop the property known as Lucent Station.

We are pleased to make our submittal for a Planned Development, addressing the comments provided by the County on March 10, 2026. We have provided below a response to all written County comments.

Sincerely,  
Norris Design

*Mallory Mooney*

Mallory Mooney  
Project Manager



**The following agencies had no additional comments:**

- Addressing Analyst
- Arapahoe County Engineering Services Division
- Arapahoe County PWD/ Planning
- AT&T Long Distance – ROW
- Backcountry Association, Inc
- Building Services
- CenturyLink
- City of Centennial
- Colorado Division of Water Resources
- Comcast
- Douglas County Health Department
- Douglas County Housing Partnership
- Douglas County Water Commission
- Engineering Services
- High Line Canal Conservancy
- Highlands Ranch Golf Club HOA
- Highlands Ranch Metro District
- Jefferson County Planning and Zoning
- Littleton - Planning
- Mile High Flood District
- Office of Emergency Management
- RTD - Planning & Development Dept
- Sheriff's Office
- Sheriff's Office E911
- South Metro Fire Rescue

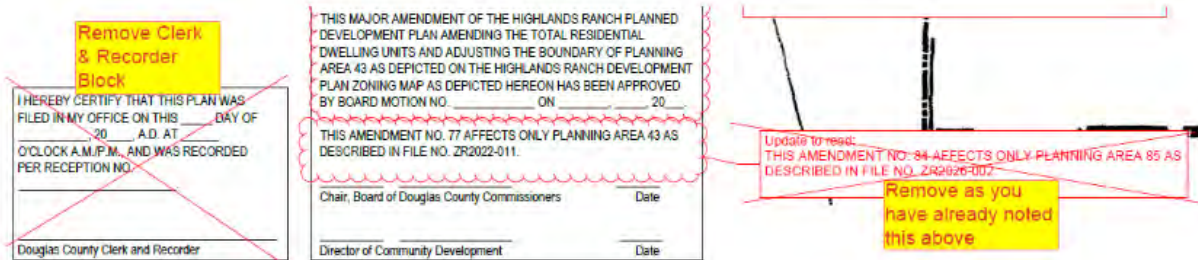
**DOUGLAS COUNTY STAFF AND REFERRAL COMMENTS:**

Planning

1. I have no additional project narrative comments at this time.

**Response: Thank you for your review.**

2. I have two minor cleanup comments on the HRPD plan exhibit. See below. Please complete and provide me a revised PD redline exhibit.



**Response: These items have been revised as indicated and a clean version of the PD Amendment is included with this resubmittal.**

3. Please prepare a “clean” version of the PD exhibit with all corrections shown. I am able to discuss preparation of this exhibit anytime.

**Response: Please see the “clean” version of the PD exhibit, included with this resubmittal.**



*Summary of major referral response comments:*

4. Douglas County Parks, Trails and Buildings Grounds responded to the referral and indicated that the applicant is responsible for meeting park land dedication requirements outlined in Article 10, Section 1003 of the Douglas County Subdivision Resolution (DCSR). Final determination of land dedication acreage or cash-in-lieu of land dedication fees would occur as part of a future Site Improvement Plan (SIP) or platting process (if necessary) following a property appraisal. No comments regarding parks, recreation, or open space were provided by the Highlands Ranch Community Association or the Highlands Ranch Metro District.

**Response: Comment noted; park land dedication or cash-in-lieu will be met at the appropriate time.**

5. Douglas County School District (DCSD) estimated an impact of 18 elementary students, 3 middle school students, and 6 high school students from the development. This generates a land dedication requirement of 0.578 acres. DCSD requests cash-in-lieu of land dedication to be calculated per DCSR Section 1004.05.03. Final calculation of cash-in-lieu fees would be determined during a future SIP or plat process (if needed) following a property appraisal.

**Response: Comment noted; land dedication or cash-in-lieu will be met at the appropriate time.**

6. In your response letter to referral comments, please also respond to the outstanding referral comments not summarized above from CDOT, City of Littleton Engineering, Highlands Ranch Water, and Xcel Energy.

**Response: Noted; please see responses to these agencies in the letter below.**

*Community outreach:*

7. Douglas County encourages community outreach with abutting property owners, nearby neighbors, and homeowners' associations, as these groups may have interest in the proposed PD amendment. If any correspondence is generated from outreach efforts (aside from the referral response received from HRCA) please provide such documentation to staff.

**Response: A first virtual neighborhood meeting was held via Zoom Webinar on April 16, 2025. At that time, no residents or stakeholders attended. In order to assure the development team that the community has had enough opportunity to share their opinions and concerns, another virtual neighborhood meeting is planned for April 2, 2026 at 6 PM. A summary of this meeting will be provided to the County as soon as the meeting is complete.**

Colorado Department of Transportation CDOT-Region # 1

1. Due to the proximity of this development to the C470 EB ramp we would like to review the drainage report to confirm no negative impact.

**Response: The drainage report will be provided for review as part of the Site Improvement Plan process.**

2. Any signing for this development visible to the state highway must be compliant with the state rules for outdoor advertising per 2 CCR 601-3.

**Response: Any signage visible to the state highway would be compliant with state standards.**



3. We ask that the county continue to monitor cumulative impact of development on the Kendrick Castillo Way and C470 interchange.

**Response: The interchange of Kendrick Castillo Way and C-470 interchange was evaluated in the traffic study for the existing, buildout, and 20-year horizons.**

#### DOUGLAS COUNTY PARKS AND TRAILS

1. Applicant would be responsible for meeting park land dedication as outlined in Article 10 of the Douglas County Subdivision Resolution.

**Response: Comment noted; park land dedication or cash-in-lieu will be met at the appropriate time.**

4. Whenever land is proposed for residential or non-residential use, the owner of the land is to provide land or cash-in-lieu of land for active and specialized recreation generated by the proposed use. In general, these lands need to be suitable for the development of active play areas, trails, or in some instances serve to preserve unique landforms or natural areas. Where no suitable land is available in a residential or non-residential development, cash-in-lieu of land or of equivalent value in the donation of recreational facilities may be substituted at the County's discretion. Additional dedication for open land may be required by the Board if deemed necessary to preserve areas of special countywide significance (refer to Sections 1003.11.5 and 1003.12.5 of these regulations

**Response: Comment noted; Applicant will work with Douglas County at the appropriate time to provide park land dedication or cash-in-lieu.**

2. The following formula is used to calculate the minimum amount of land dedication required in residential developments which is deemed necessary to provide the needed parks. This formula is based on 15 acres/1000 population.

Local Park = Dwelling units x 0.015 acres/unit

Regional Park = Dwelling units x 0.030 acres/unit

Total = Dwelling units x 0.045 acres/unit

The Board reserves the right to adjust the acreage requirement between local and regional park categories as deemed necessary to meet specific needs and to determine the amount of developed park acreage required. The Board may also consider alternative park land dedication formulas for multi-family development proposals.

**Response: Comment noted.**

#### DOUGLAS COUNTY SCHOOL DISTRICT RE 1

1. DCSD calculated a land dedication requirement of 0.578 acres from the 18 elementary, 3 middle school, and 6 high school students generated from the development. DCSD requests cash-in-lieu of land dedication per Douglas County Subdivision Resolution 1004.05.03 at Site Plan approval. DCSD has no objection to the proposal provided the applicant agrees to this request.

**Response: Comment noted; thank you for your review.**

#### HIGHLANDS RANCH COMMUNITY ASSOCIATION

1. HRCA appreciates the opportunity to review and opine on this application. We have reviewed the applicant's revised Planned Development amendment (ZR2026-002), which proposes to add 350 residential dwelling units within Planning Area 85 of the Highlands Ranch Planned Development (HRPD). In 2025, HRCA reviewed a substantially



similar request involving approximately 400 units and communicated that it took no exceptions to the amendment.

The current submittal reflects a reduction in total dwelling units (350 vs. 400), clarifies the residential product mix, and includes additional documentation related to infrastructure capacity and traffic mitigation measures. The proposal does not introduce a new land use, expand the development footprint beyond Planning Area 85, or increase overall development intensity beyond what HRCA previously reviewed.

Based on this review, HRCA takes No Exceptions to the proposed 84th Amendment (ZR2026-002).

We take this opportunity to remind the applicant that a formal submittal, made directly to HRCA, for review (via our Development Review Committee, DRC) of the SITE IMPROVEMENT PLAN, is required when this project moves into that phase.

**Response: Comment noted; thank you for your review. A Site Improvement Plan will be submitted to the DRC at the appropriate time.**

#### HIGHLANDS RANCH WATER AND SANITATION DISTRICT

1. Site, civil, architectural and MEP plans must be submitted for review and approval.  
**Response: Comment noted; when these plans are available, they will be shared for review.**
2. Contact the Financial Analyst for required fees.  
**Response: The project team will coordinate with the Financial Analyst regarding the required fees.**

#### LITTLETON ENGINEERING

1. Littleton Engineering requests that the intersection of Erickson Boulevard and County Line Road be included in the traffic study so Littleton can confirm that intersection has capacity to accommodate peak hour traffic.  
**Response: The project team is coordinating with the City of Littleton to determine the extent of this requirement. This was the second application for this PD Amendment. Our first application was last year for a higher density of up to 400-units. As part of that application, we coordinated with Chris Martin at the County on the scope of the traffic study and the study was previously approved by County staff and already had PC and BOCC hearings without adding the intersection of Erickson Blvd and County Line Road. This second application is for a lower density of up to 350-units and we do not anticipate any impact to the LOS at the intersection of Erickson Blvd and County Line Road that is approximately 1-mile travel distance from the Site. We are still determining whether this request is still needed by the City of Littleton.**

#### RTD – PLANNING & DEVELOPMENT DEPT

1. No comment  
**Response: Thank you for your review.**

#### XCEL ENERGY – ROW & PERMITS

1. In the future, for these multi-family apartment-type lots, and to ensure that adequate utility easements are available within this development and per state statutes §31-23-214 (3) and 30-28-133(e), PSCo requests that the following language or plat note be placed on the preliminary and final plats for the subdivision:



Minimum 10-foot-wide dry utility easements are hereby dedicated on private property abutting all public streets, and around the perimeter of each lot or platted area including tracts, parcels and/or open space areas. These easements are dedicated to the County of Douglas for the benefit of the applicable utility providers for the installation, maintenance, and replacement of electric, gas, television, cable, and telecommunications facilities (Dry Utilities). Utility easements shall also be granted within any access easements and private streets in the subdivision. Permanent structures, improvements, objects, buildings, wells, water meters and other objects that may interfere with the utility facilities or use thereof (Interfering Objects) shall not be permitted within said utility easements and the utility providers, as grantees, may remove any Interfering Objects at no cost to such grantees, including, without limitation, vegetation. Public Service Company of Colorado (PSCo) and its successors reserve the right to require additional easements and to require the property owner to grant PSCo an easement on its standard form.

**Response: Comment noted.**

2. Also, Public Service Company has an existing high-pressure natural gas transmission pipeline along the south property line of parcel 2. Any activity including grading, proposed landscaping, erosion control or similar activities involving our existing right-of-way will require Public Service Company approval. Encroachments across Public Service Company's easements must be reviewed for safety standards, operational and maintenance clearances, liability issues, and acknowledged with a Public Service Company License Agreement to be executed with the property owner. PSCo is requesting that, prior to any final approval of the development plan, it is the responsibility of the property owner/developer/contractor to contact PSCo's Encroachment Team for development plan review and execution of a License Agreement (upload all files in PDF format) at: [cloud.marketing.xcelenergy.com/encroachment](https://cloud.marketing.xcelenergy.com/encroachment).

**Response: Comment noted.**

3. The property owner/developer/contractor must complete the application process for any new natural gas or electric service, or modification to existing facilities via Building and Remodeling | Partner Resources | Xcel Energy. It is then the responsibility of the developer to contact the Xcel Designer assigned to the project for approval of design details.

**Response: Comment noted.**

4. Additional easements may need to be acquired by separate document. The Designer must contact the appropriate Right-of-Way Agent.

**Response: Comment noted.**

5. As a safety precaution, PSCo would like to remind the developer to contact Colorado 811 for utility locates prior to construction.

**Response: Comment noted.**

*End of comment response letter.*



## MEETING NOTES

<b>PROJECT:</b>	HR PD Amendment #80	<b>DATE:</b>	4/16/25
<b>SUBJECT:</b>	Neighborhood Meeting	<b>TIME:</b>	6:00 PM
<b>MINUTES BY:</b>	Mallory Mooney	<b>LOCATION:</b>	Zoom

COMPANY	ATTENDEES	EMAIL
<i>Development Team:</i>		
Pagewest	Adam Wallace	x@x.com
Norris Design	Daniel Jennings	
Norris Design	Mallory Mooney	
Kimley-Horn	Jeff Planck	
Kimley-Horn	Eric McDaniel	
<i>Neighbors:</i>		

**Summary:**

The development team hosted a virtual neighborhood meeting on Wednesday, April 16, 2025 at 6:00 PM. Notices were sent to adjacent property owners and stakeholders on Thursday, April 3, 2025. However, as of 6:15 PM, no one other than the development team was in attendance. As a result, the team ended the meeting early.

**Questions/Comments:**

None.

# TRAFFIC IMPACT STUDY

## Lucent Station Douglas County, Colorado

Prepared for:

**Pagewest Acquisitions, LLC**

**Kimley»Horn**

**Lucent Station**

Douglas County, Colorado

**Prepared for**  
**Pagewest Acquisitions, LLC**  
2106 W 32<sup>nd</sup> Avenue  
Denver, Colorado 80211

**Prepared by**  
**Jeffrey R. Planck, P.E.**  
**Kimley-Horn and Associates, Inc**  
6200 South Syracuse Way  
Suite 300  
Greenwood Village, Colorado 80111  
(303) 228-2300



February 2026

*This document, together with the concepts and designs presented herein, as an instrument of service, is intended only for the specific purpose and client for which it was prepared. Reuse of and improper reliance on this document without written authorization and adaptation by Kimley-Horn and Associates, Inc. shall be without liability to Kimley-Horn and Associates, Inc.*

## TABLE OF CONTENTS

TABLE OF CONTENTS .....	i
LIST OF TABLES .....	ii
LIST OF FIGURES .....	ii
1.0 EXECUTIVE SUMMARY .....	1
2.0 INTRODUCTION .....	4
3.0 EXISTING AND FUTURE CONDITIONS .....	7
3.1 Existing Study Area .....	7
3.2 Existing Roadway Network .....	7
3.3 Existing Traffic Volumes .....	16
3.4 Unspecified Development Traffic Growth .....	16
4.0 PROJECT TRAFFIC CHARACTERISTICS .....	20
4.1 Trip Generation .....	20
4.2 Trip Distribution .....	21
4.3 Traffic Assignment .....	21
4.4 Total (Background Plus Project) Traffic .....	21
5.0 TRAFFIC OPERATIONS ANALYSIS .....	26
5.1 Analysis Methodology .....	26
5.2 Key Intersection Operational Analysis .....	27
5.3 Vehicle Queuing Analysis .....	37
5.4 Improvement Summary .....	39
6.0 CONCLUSIONS AND RECOMMENDATIONS .....	41

### Appendices

Appendix A: Conceptual Site Plan

Appendix B: Intersection Count Sheets

Appendix C: Future Traffic Projections

Appendix D: Trip Generation Worksheets

Appendix E: Intersection Analysis Worksheets

Appendix F: Queue Analysis Worksheets

Appendix G: Signal Warrant Analysis Worksheet

## LIST OF TABLES

Table 1 – Lucent Station Traffic Generation .....	20
Table 2 – Level of Service Definitions .....	26
Table 3 – Erickson Boulevard/Mill Vista Road & Plaza Drive LOS Results.....	28
Table 4 – Plaza Circle & Plaza Drive LOS Results.....	30
Table 5 – Plaza Circle & Percy Lane/Project Access LOS Results.....	31
Table 6 – Greensborough Drive & Plaza Drive LOS Results .....	33
Table 7 – Kendrick Castillo Way & Plaza Drive LOS Results .....	34
Table 8 – Kendrick Castillo Way & C-470 Eastbound Ramps LOS Results.....	35
Table 9 – Kendrick Castillo Way & C-470 Westbound Ramps LOS Results.....	36
Table 10 – Project Access Level of Service Results.....	37
Table 11 – Turn Lane Queuing Analysis Results.....	38

## LIST OF FIGURES

Figure 1 – Vicinity Map.....	5
Figure 2 – Existing Geometry and Control.....	15
Figure 3 – 2025 Existing Traffic Volumes.....	17
Figure 4 – 2028 Background Traffic Volumes.....	18
Figure 5 – 2045 Background Traffic Volumes.....	19
Figure 6 – Project Trip Distribution.....	22
Figure 7 – Project Traffic Assignment .....	23
Figure 8 – 2028 Total Traffic Volumes .....	24
Figure 9 – 2045 Total Traffic Volumes .....	25
Figure 10 – Recommended Geometry and Control.....	40

## 1.0 EXECUTIVE SUMMARY

---

Lucent Station is proposed to be located along the north side of Plaza Drive, between Plaza Circle and Kendrick Castillo Way, in Highlands Ranch within unincorporated Douglas County, Colorado. For the purposes of this analysis, the project is anticipated to include a total of 350 residential units with 84 single family attached units and 266 multifamily units. It is expected that the project will be completed in the next several years. Therefore, analysis was conducted for the 2028 short-term buildout horizon as well as the 2045 long-term twenty-year planning horizon.

The purpose of this traffic study is to identify project traffic generation characteristics to determine potential project traffic related impacts on the local street system and to develop the necessary mitigation measures required for the identified traffic impacts. The following intersections were incorporated into this traffic study in accordance with Douglas County standards and requirements:

- Erickson Boulevard/Mill Vista Road and Plaza Drive
- Plaza Circle and Plaza Drive
- Plaza Circle and Percy Lane
- Plaza Circle/Greensborough Drive and Plaza Drive
- Kendrick Castillo Way and Plaza Drive
- Kendrick Castillo Way and C-470 Eastbound Ramps
- Kendrick Castillo Way and C-470 Westbound Ramps

In addition, the three (3) full movement and one (1) right-in/right/out (RI/RO) accesses along Plaza Circle were evaluated. Each development area is proposing two accesses, with one of the access points for the west and east aligning with each other. Therefore, this results in three access intersections evaluated.

Regional access to the project will be provided by C-470 and Santa Fe Drive (US-85). Primary access will be provided by Plaza Drive, Erickson Boulevard, and Kendrick Castillo Way. Direct access to the west lot will be provided by two (2) full movement accesses, one that aligns with Percy Drive at Plaza Circle and one proposed access that aligns with the proposed access to the east lot. In addition, one (1) right-in/right-out access is proposed near the southern edge of the

east lot. The southern right-in/right-out access is proposed approximately 240 feet south of the proposed full movement access location for the west lot.

The project is expected to generate approximately 2,170 weekday daily trips, with 140 of these trips occurring during the morning peak hour and 175 of these trips occurring during the afternoon peak hour.

Based on the analysis presented in this report, Kimley-Horn believes Lucent Station will be successfully incorporated into the existing and future roadway network. Analysis of the existing street network, the proposed project development, and expected traffic volumes resulted in the following conclusions and recommendations:

- It is recommended that the intersection of Plaza Circle/Greensborough Drive and Plaza Drive (#4) be signalized. This signalized intersection will likely also improve existing long southbound left turn delays at the Plaza Circle/Ben Franklin Academy and Plaza Drive intersection (#2). Additionally, the southbound left movement at the Plaza Circle/Ben Franklin Academy and Plaza Drive intersection (#2) is recommended to be restricted during the arrival and dismissal times at the Ben Franklin Academy. This restriction would match the current restriction on the northbound approach, exiting the academy with a sign restricting the left turn movement onto Plaza Circle between 7:45-8:15 AM and 3:30-4:00 PM.
- It is recommended that the existing 250-foot southbound dual left turn lanes at the Kendrick Castillo Way and Plaza Drive (#5) intersection be extended to 300 feet in the short-term horizon and may need to be extended to 425 feet in 2045. Of note, extension of these dual left turn lanes is independent and not caused by Lucent Station.
- With completion of the Lucent Station project, a full movement access that aligns with the Percy Lane full movement access at Plaza Circle, two (2) full movement accesses in alignment with each other, and a right-in/right-out access will be provided along Plaza Circle. Left turn lanes are recommended to be designated within the double-yellow full lane width median for the Plaza Circle full movement accesses. These left turn lanes are recommended to be striped with lengths of 50 feet as is available. "STOP" (R1-1) signs are recommended to be installed on the approaches of all four (4) accesses, exiting the development. In addition,

a R3-2 No Left Turn sign should be placed underneath the R1-1 “STOP” sign for the Plaza Circle right-in/right-out access.

- Any on-site or offsite improvements should be incorporated into the Civil Drawings and conform to standards of the Douglas County and the current edition of the Manual on Uniform Traffic Control Devices (MUTCD).

## 2.0 INTRODUCTION

---

Kimley-Horn has prepared this report to document the results of a Traffic Impact Study for Lucent Station proposed to be located on the north side of Plaza Drive, between Plaza Circle and Kendrick Castillo Way, within unincorporated Douglas County. A vicinity map illustrating the project development location is shown in **Figure 1**. For the purposes of this analysis, the project is anticipated to include a total of 350 residential units with 84 single family attached units and 266 multifamily units. A conceptual site plan is attached in **Appendix A**. It is expected that the project will be completed in the next several years; therefore, analysis was conducted for the 2028 short-term buildout horizon as well as the 2045 long-term twenty-year planning horizon.

The purpose of this traffic study is to identify project traffic generation characteristics to determine potential project traffic related impacts on the local street system and to develop the necessary mitigation measures required for the identified traffic impacts. The following intersections were incorporated into this traffic study in accordance with Douglas County, Colorado standards and requirements:

- Erickson Boulevard/Mill Vista Road and Plaza Drive
- Plaza Circle and Plaza Drive
- Plaza Circle and Percy Lane
- Plaza Circle/Greensborough Drive and Plaza Drive
- Kendrick Castillo Way and Plaza Drive
- Kendrick Castillo Way and C-470 Eastbound Ramps
- Kendrick Castillo Way and C-470 Westbound Ramps

In addition, the three (3) full movement and one (1) right-in/right/out (RI/RO) accesses along Plaza Circle were evaluated. Each development area is proposing two accesses, with one of the access points for the west and east aligning with each other. Therefore, this results in three access intersections evaluated.

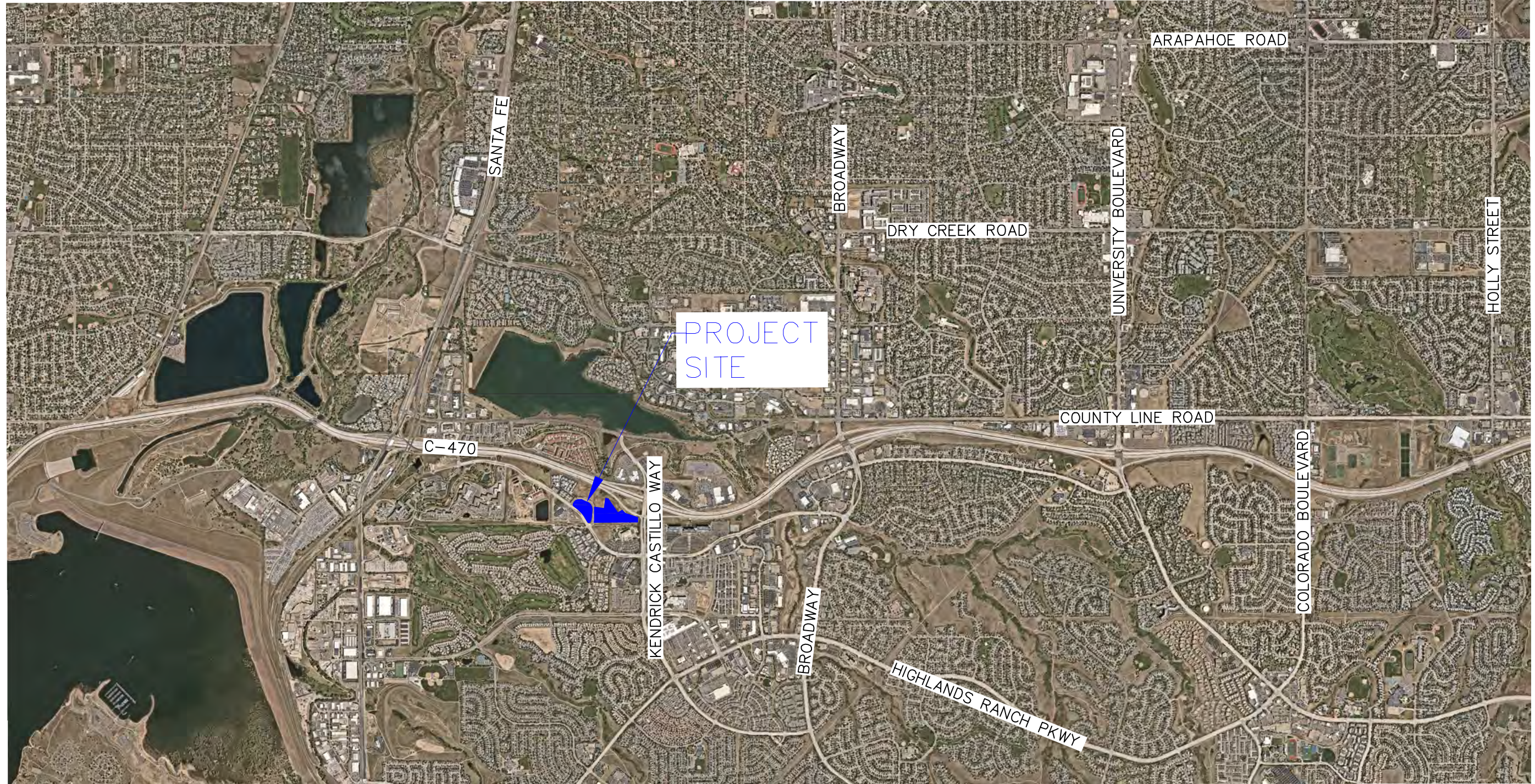


FIGURE 1  
LUCENT STATION  
DOUGLAS COUNTY, COLORADO  
VICINITY MAP

Regional access to the project will be provided by C-470 and Santa Fe Drive (US-85). Primary access will be provided by Plaza Drive, Erickson Boulevard, and Kendrick Castillo Way. Direct access to the west lot will be provided by two (2) full movement accesses, one that aligns with Percy Drive at Plaza Circle and one proposed access that aligns with the proposed access to the east lot. In addition, one (1) right-in/right-out access is proposed near the southern edge of the east lot. The southern right-in/right-out access is proposed approximately 240 feet south of the proposed full movement access location for the west lot.

## 3.0 EXISTING AND FUTURE CONDITIONS

---

### 3.1 Existing Study Area

The existing site is vacant land. Directly to the south is Children's Hospital and directly to the north is C-470. Located to the southwest is Ben Franklin Academy. Solana Lucent Station multifamily apartments exist to the west of the site with Centennial Water located further to the west, along the south side of Plaza Drive. Surrounding the site are a mix of multifamily housing and other undeveloped parcels.

### 3.2 Existing Roadway Network

Erickson Boulevard extends north-south as a short section street providing two through lanes in each direction. It connects County Line Road along the north side of C-470 to Plaza Drive along the south side of C-470. The posted speed limit is 30 miles per hour.

Plaza Drive extends east-west with two through lanes in each direction and a raised median. The posted speed limit is 40 miles per hour.

Kendrick Castillo Way extends north-south with three through lanes in each direction with a raised median. The posted speed limit is 40 miles per hour in the study area. Kendrick Castillo Way provides a C-470 interchange and extends from County Line Road to the north to Broadway to the south.

The unsignalized intersection of Erickson Boulevard/Mill Vista Road and Plaza Drive operates with all-way stop control on all four approaches. The westbound Plaza Drive and southbound Erickson Boulevard approaches provide a left turn lane, a through lane, and a right turn lane. The eastbound Plaza Drive approach provides a left turn lane and a shared through/right turn lane. The northbound Mill Vista Road approach provides a single lane shared for all movements. An aerial photo of the existing intersection configuration is below.



*Erickson Boulevard/Mill Vista Road and Plaza Drive (#1)*

The unsignalized intersection of Plaza Circle and Plaza Drive operates with two-way stop control on the northbound Ben Franklin Academy Access and southbound approaches. The eastbound and westbound Plaza Drive approaches provide a left turn lane, a through lane, and a shared through/right lane. The southbound Plaza Circle approach provides a left turn lane and a shared through/right turn lane. The northbound Ben Franklin Academy approach provides a left turn lane and right turn lane. An aerial photo of the existing intersection configuration is below.



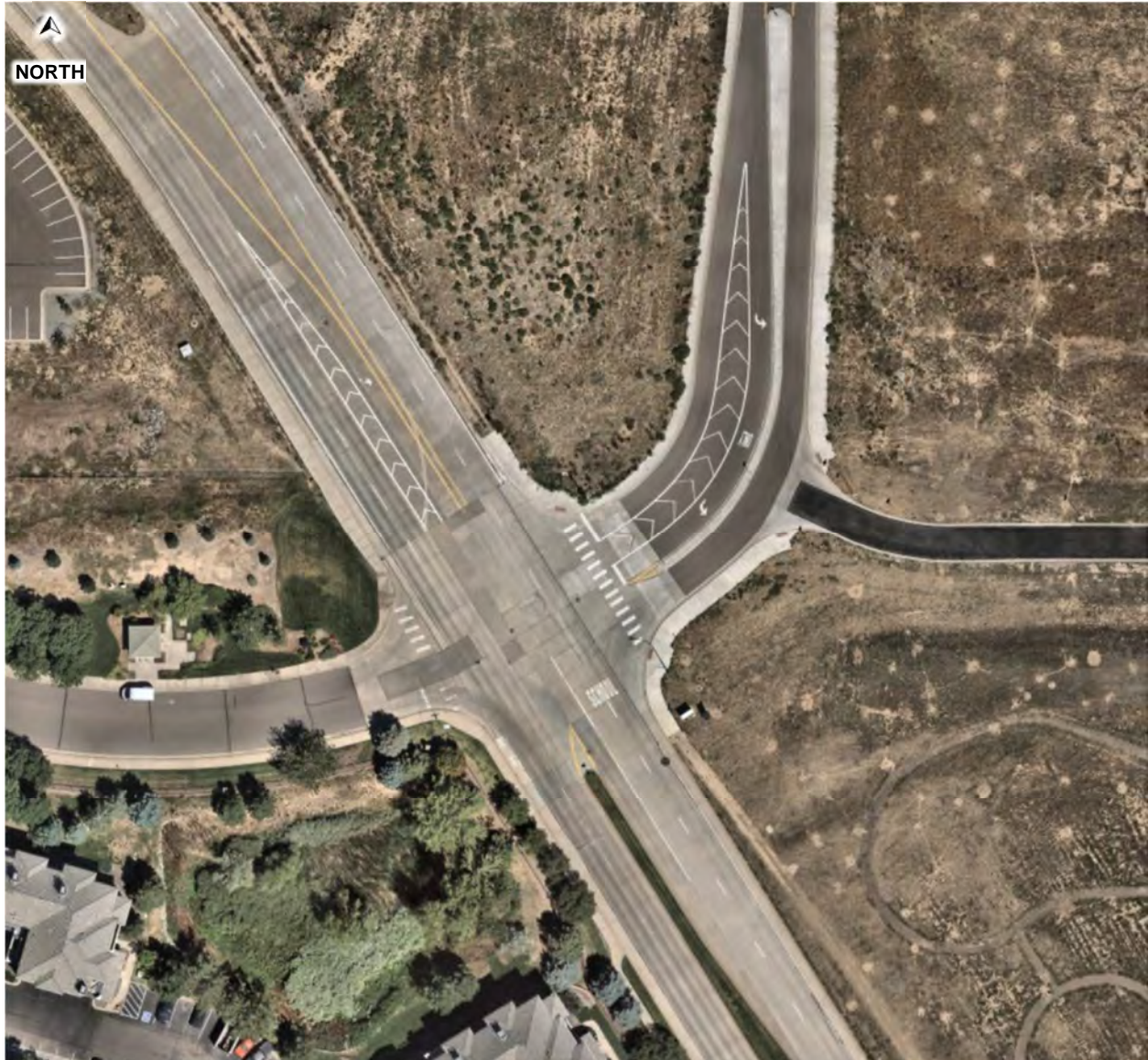
*Plaza Circle and Plaza Drive (#2)*

The unsignalized intersection of Plaza Circle and Percy Lane operates with two-way stop control on the eastbound access approach. The eastbound Percy Lane approach provides a single lane shared for all movements. The northbound Plaza Drive approach provides a left turn lane and a through lane. The southbound Plaza Drive approach provides a single lane shared for all movements. An aerial photo of the existing intersection configuration is below.



*Plaza Circle and Percy Lane (#3)*

The unsignalized intersection of Plaza Circle/Greensborough Drive and Plaza Drive operates with two-way stop control on the northbound and southbound approaches. The eastbound and westbound Plaza Drive approaches provide a left turn lane, a through lane, and a shared through/right lane. The southbound Plaza Circle approach provides a left turn lane and a shared through/right turn lane. The northbound Greensborough Drive approach provides a single lane shared for all movements. An aerial photo of the existing intersection configuration is below.



*Plaza Circle/Greensborough Drive and Plaza Drive (#4)*

The signalized intersection of Kendrick Castillo Way and Plaza Drive operates with protected-only left turn phasing on all four approaches. The northbound and southbound approaches of Kendrick Castillo Way provide dual left turn lanes and three through lanes with the outside lane being a shared through/right turn. The eastbound approach on Plaza Drive provides dual left turn lanes and two through lanes with the outside lane being a shared through/right turn lane. The westbound approach of Plaza Drive provides dual left turn lanes, two through lanes, and a right turn lane. An aerial photo of the existing intersection configuration is below.



*Kendrick Castillo Way and Plaza Drive (#5)*

The signalized intersection of Kendrick Castillo Way and C-470 eastbound ramps operates with protected-permissive left turn phasing on the southbound approach. The northbound approach of Kendrick Castillo Way provides three through lanes (with the inside lane becoming a dual left turn lane at the C-470 westbound ramps intersection), and a continuous right turn lane. The southbound approach on Kendrick Castillo Way provides a single left turn lane and two through lanes. The eastbound approach of C-470 provides a dedicated left turn lane, a shared left turn/through/right turn lane, and a free right turn lane. An aerial photo of the existing intersection configuration is below.



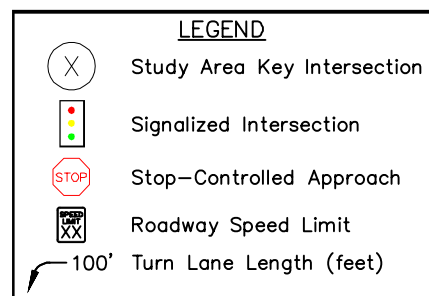
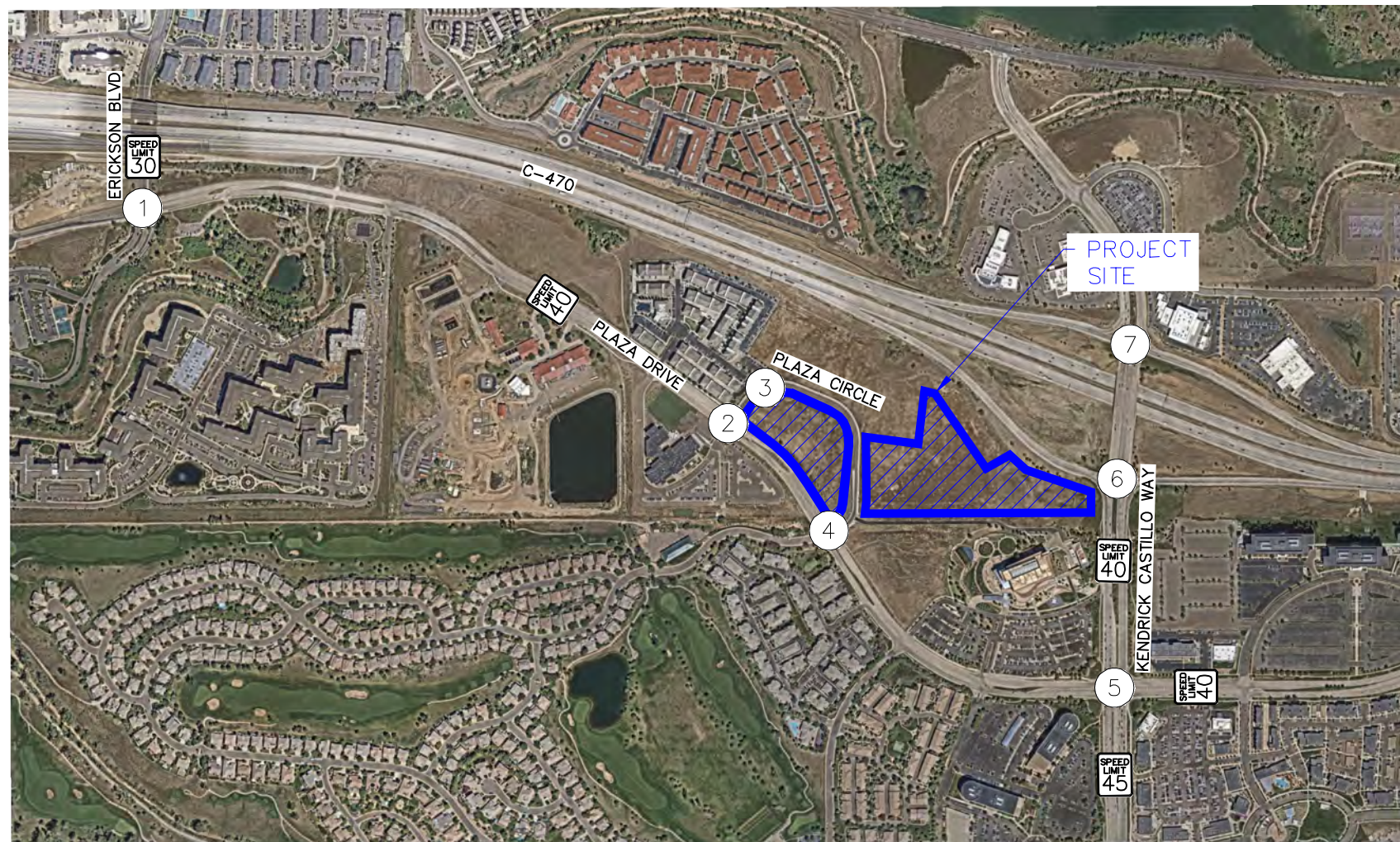
*Kendrick Castillo Way and C-470 Eastbound Ramps (#6)*

The signalized intersection of Kendrick Castillo Way and C-470 westbound ramps operates with protected-only left turn phasing on the northbound approach. The northbound approach of Kendrick Castillo Way provides dual left turn lanes and two through lanes. The southbound approach on Kendrick Castillo Way provides two through lanes and a free right turn lane. The westbound approach of C-470 provides a dedicated left turn lane, a shared left turn/through/right turn lane, and a free right turn lane. An aerial photo of the existing intersection configuration is below.

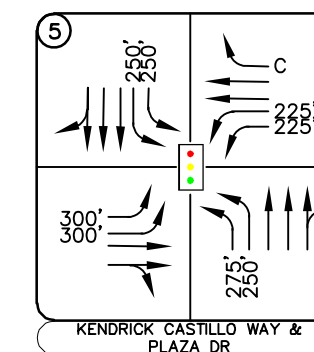
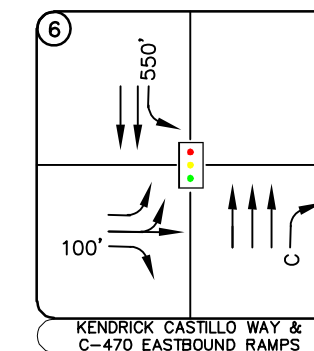
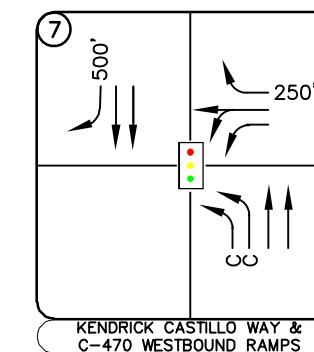
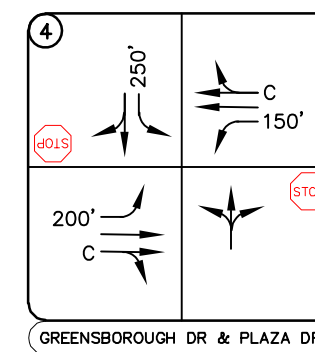
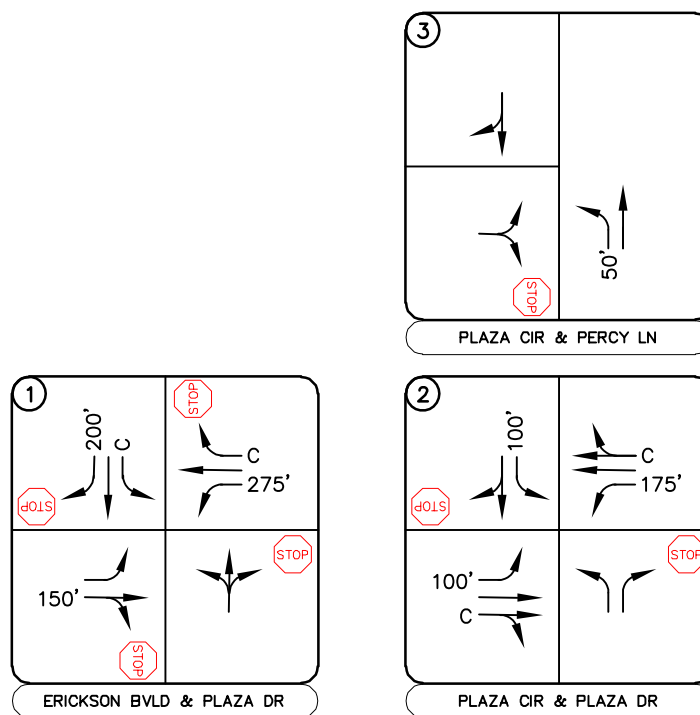


*Kendrick Castillo Way and C-470 Westbound Ramps (#7)*

The intersection lane configuration and control for the study area intersections are shown in **Figure 2**.



**FIGURE 2**  
LUCENT STATION  
DOUGLAS COUNTY, COLORADO  
EXISTING GEOMETRY AND CONTROL

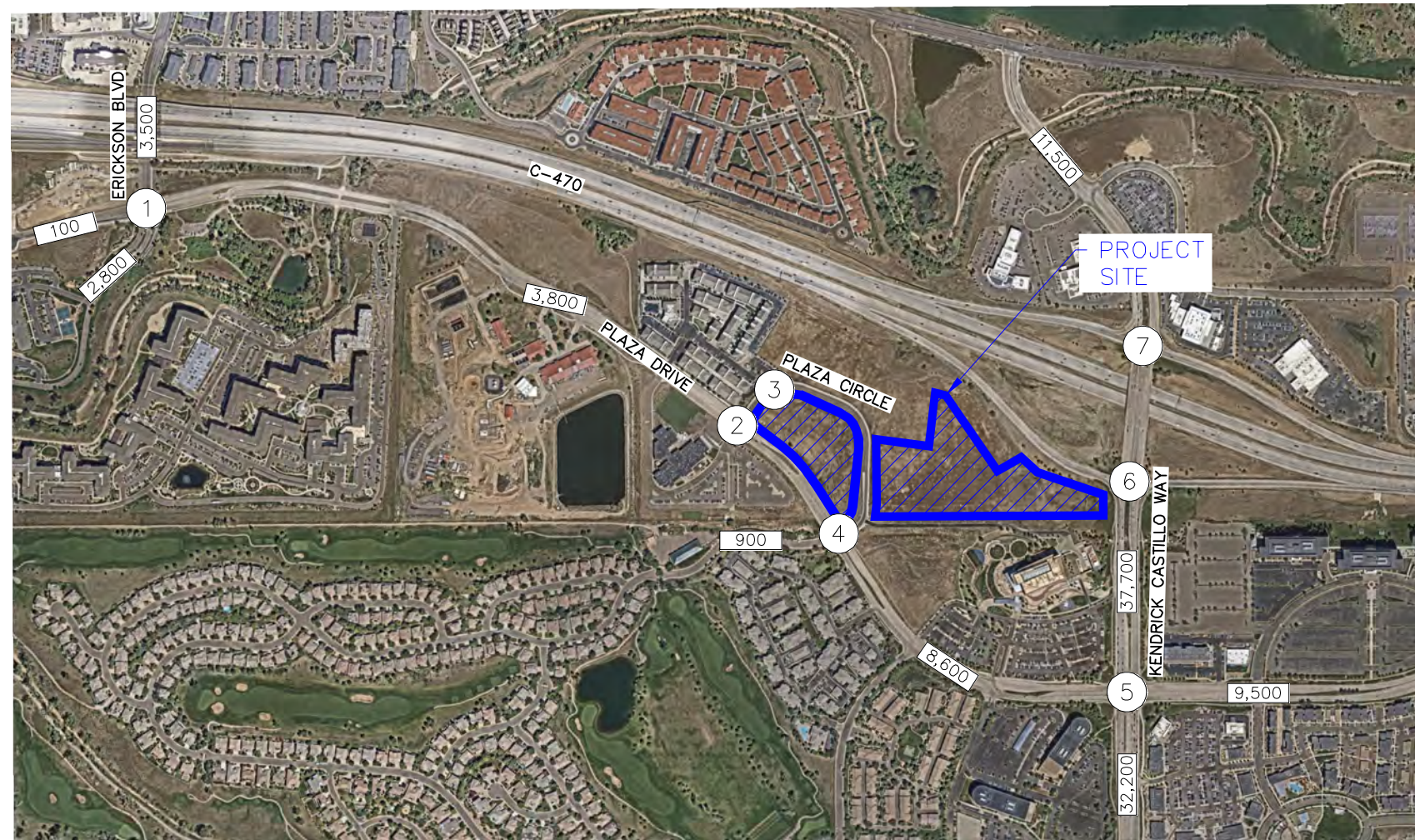


### 3.3 Existing Traffic Volumes

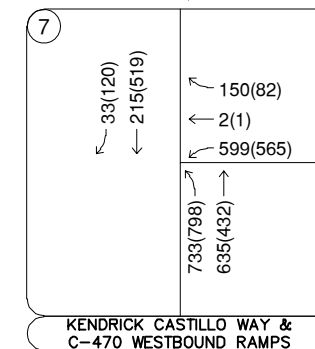
Existing turning movement counts were conducted at the study intersections on Wednesday, January 22, 2025, and Wednesday, January 29, 2025, during the weekday morning and afternoon peak hours. The counts were conducted during the morning and afternoon peak hours of adjacent street traffic in 15-minute intervals from 7:00 AM to 9:00 AM and 4:00 PM to 6:00 PM on these count dates. The existing intersection traffic volumes are shown in **Figure 3** with count sheets provided in **Appendix B**.

### 3.4 Unspecified Development Traffic Growth

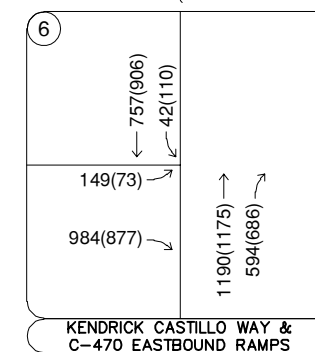
The Douglas County Transportation Plan does not provide existing and future traffic volumes that can be used to calculate an annual growth rate. The surrounding area is mostly developed and according to traffic projections from the Denver Regional Council of Governments (DRCOG) traffic model, the area surrounding the site is expected to have an annual traffic growth rate of 0.19 percent . Future traffic volume projections and growth rate calculations are provided in **Appendix C**. To be conservative, a one (1) percent annual growth rate was used to calculate future traffic volumes at the study area intersections. It is understood there may be additional development near the project site; however, it is believed that site-specific traffic studies will be required and prepared for any future development projects. Therefore, the one (1) percent annual growth rate is applicable and sufficient to understand the future traffic conditions. This annual growth rate was used to estimate short-term 2028 and long-term 2045 traffic volume projections at the key intersections. The calculated background traffic volumes for 2028 and 2045 are shown in **Figure 4** and **Figure 5**, respectively.



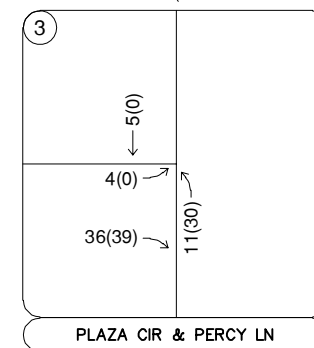
Wednesday, January 29, 2025  
 7:30 to 8:30AM (4:15 to 5:15PM)



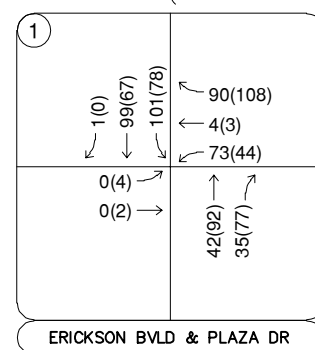
Wednesday, January 22, 2025  
 7:15 to 8:15AM (4:30 to 5:30PM)



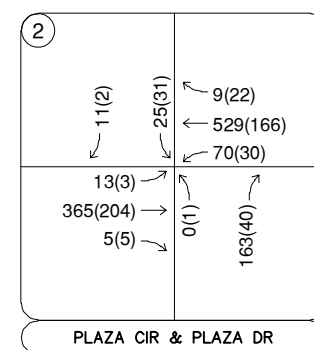
Wednesday, January 22, 2025  
 7:15 to 8:15AM (4:30 to 5:30PM)



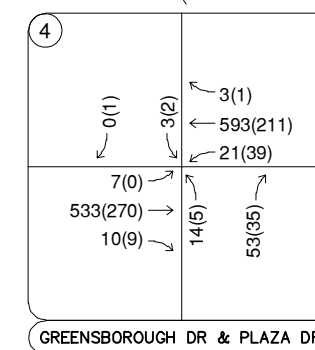
Wednesday, January 22, 2025  
 7:45 to 8:45AM (4:00 to 5:00PM)



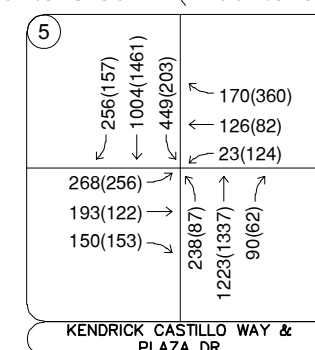
Wednesday, January 22, 2025  
 7:30 to 8:30AM (4:00 to 5:00PM)



Wednesday, January 22, 2025  
 7:30 to 8:30AM (4:00 to 5:00PM)



Wednesday, January 29, 2025  
 7:30 to 8:30AM (4:00 to 5:00PM)



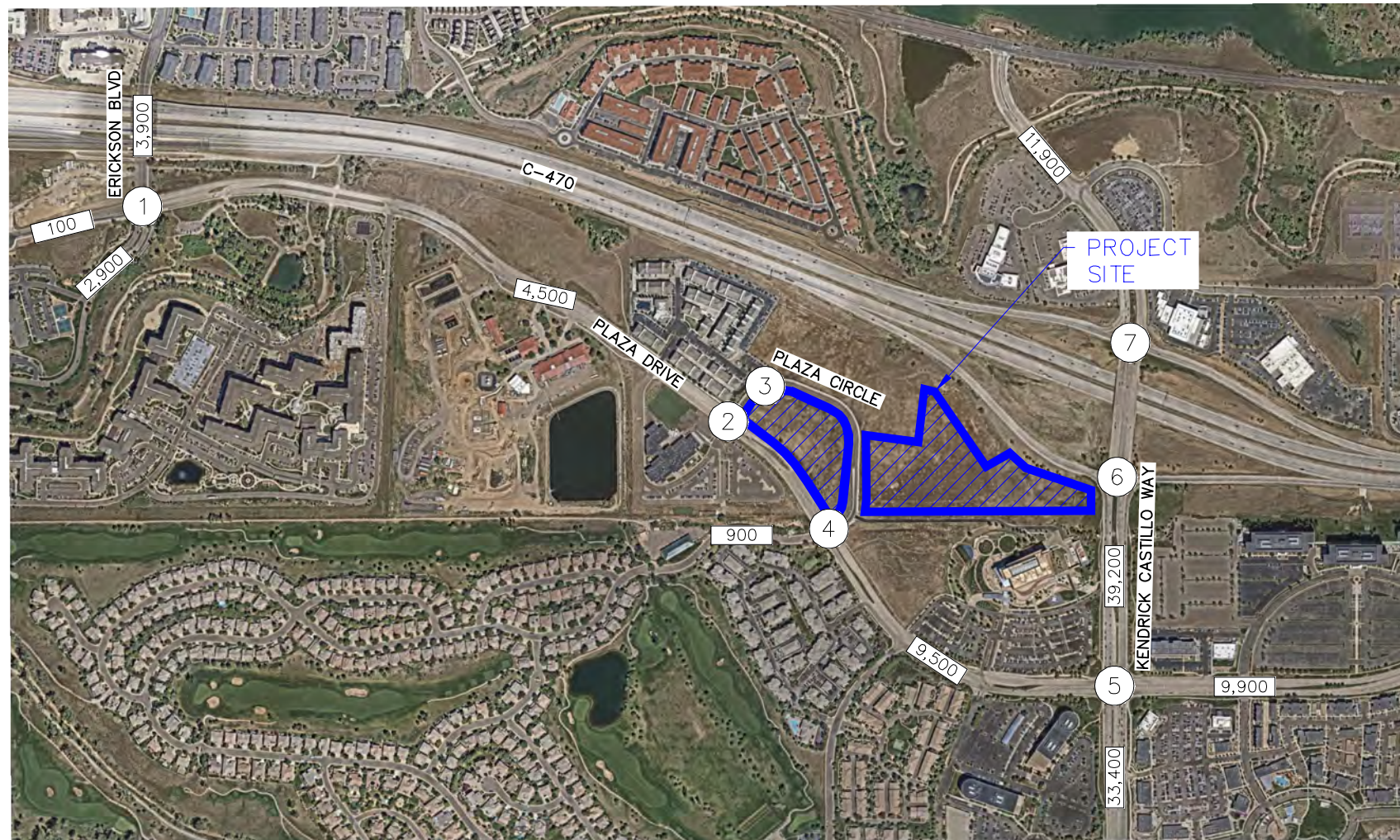
**LEGEND**

(X) Study Area Key Intersection

XXX(XXX) Weekday AM(PM) Peak Hour Traffic Volumes

XX,X00 Estimated Daily Traffic Volume

**FIGURE 3**  
**LUCENT STATION**  
**DOUGLAS COUNTY, COLORADO**  
**2025 EXISTING TRAFFIC VOLUMES**



7	<p>← 34(124)</p> <p>← 224(539)</p> <p>↑ 155(84)</p> <p>← 2(1)</p> <p>↑ 620(590)</p> <p>↑ 755(822)</p> <p>↑ 654(445)</p>
KENDRICK CASTILLO WAY & C-470 WESTBOUND RAMPS	

6	<p>← 785(945)</p> <p>← 43(113)</p> <p>↑ 154(75)</p> <p>↑ 1017(912)</p> <p>↑ 1226(1211)</p> <p>↑ 612(707)</p>
KENDRICK CASTILLO WAY & C-470 EASTBOUND RAMPS	

3	<p>← 5(0)</p> <p>↑ 4(0)</p> <p>↑ 37(40)</p> <p>↑ 11(31)</p>
PLAZA CIR & PERCY LN	

1	<p>← 1(0)</p> <p>← 102(69)</p> <p>← 112(100)</p> <p>↑ 118(124)</p> <p>← 4(3)</p> <p>↑ 75(45)</p> <p>↑ 0(4)</p> <p>↑ 0(2)</p> <p>↑ 43(65)</p> <p>↑ 36(79)</p>
ERICKSON BLVD & PLAZA DR	

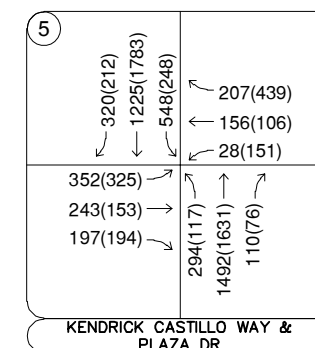
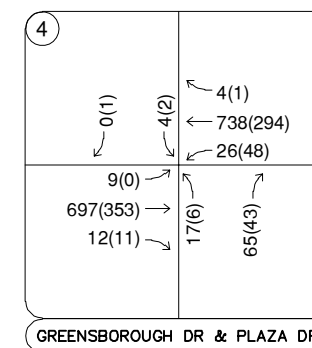
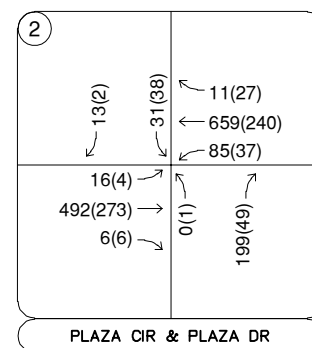
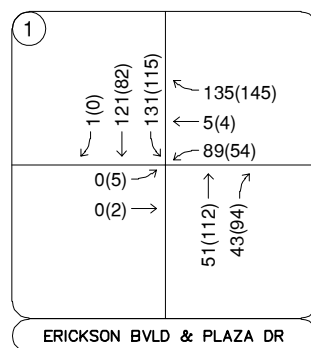
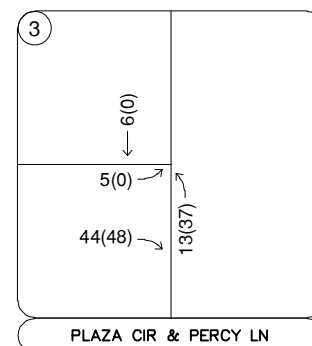
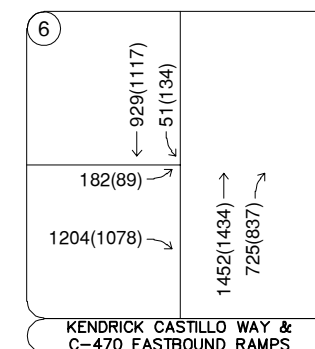
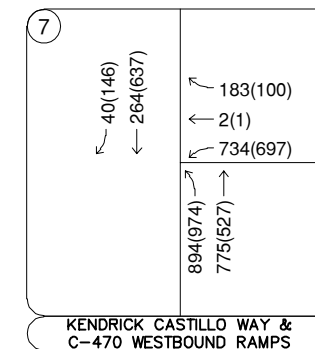
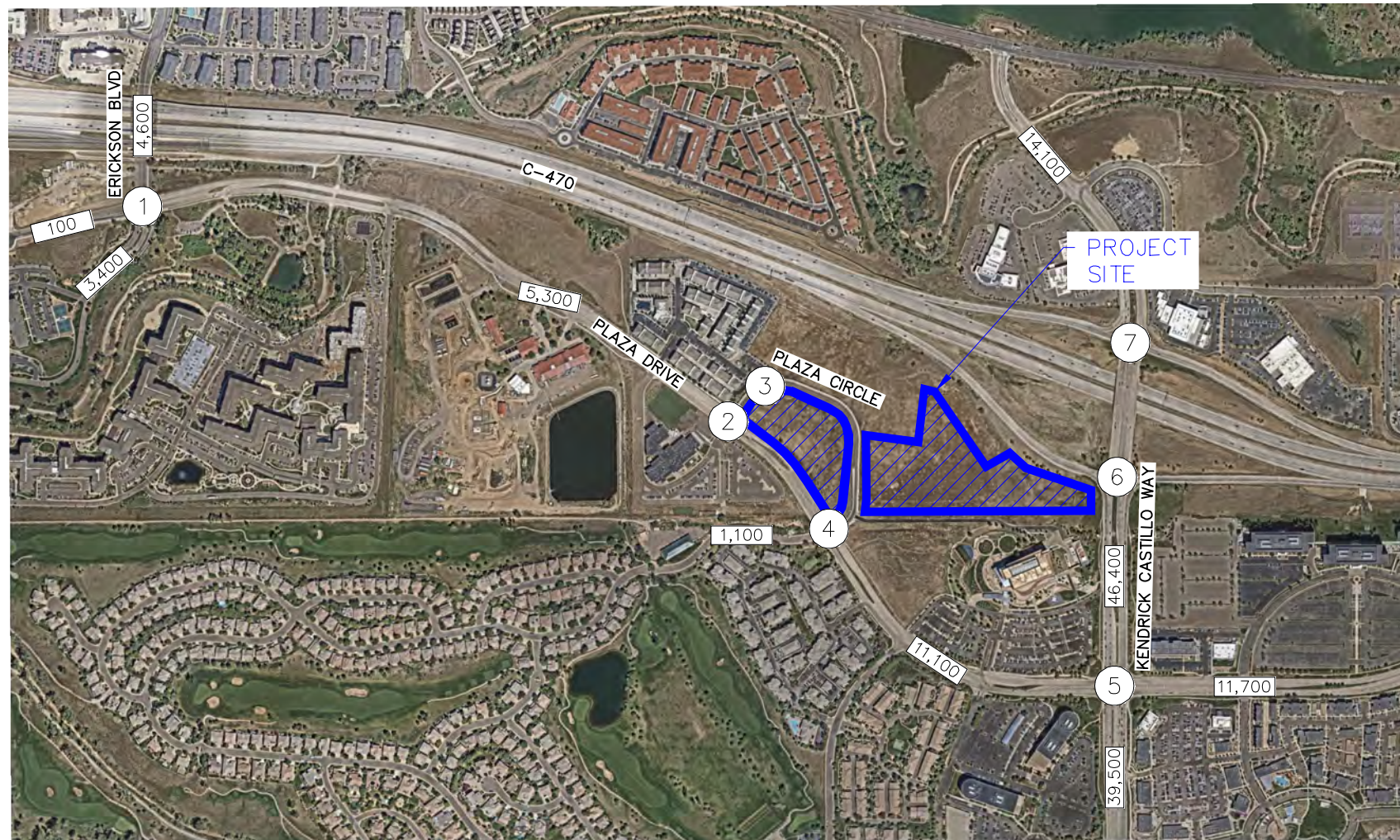
2	<p>← 11(2)</p> <p>← 26(32)</p> <p>↑ 9(23)</p> <p>← 559(208)</p> <p>↑ 72(31)</p> <p>↑ 13(3)</p> <p>↑ 423(234)</p> <p>↑ 5(5)</p> <p>↑ 0(1)</p> <p>↑ 168(41)</p>
PLAZA CIR & PLAZA DR	

4	<p>← 0(1)</p> <p>← 3(2)</p> <p>↑ 3(1)</p> <p>← 625(254)</p> <p>↑ 22(40)</p> <p>↑ 7(0)</p> <p>↑ 596(302)</p> <p>↑ 10(9)</p> <p>↑ 14(5)</p> <p>↑ 55(66)</p>
GREENSBOROUGH DR & PLAZA DR	

5	<p>← 272(182)</p> <p>← 1034(1505)</p> <p>← 463(209)</p> <p>↑ 175(371)</p> <p>← 132(90)</p> <p>↑ 24(128)</p> <p>↑ 301(277)</p> <p>↑ 207(130)</p> <p>↑ 169(165)</p> <p>↑ 249(101)</p> <p>↑ 1260(1378)</p> <p>↑ 93(64)</p>
KENDRICK CASTILLO WAY & PLAZA DR	

LEGEND	
(X)	Study Area Key Intersection
XXX(XXX)	Weekday AM(PM) Peak Hour Traffic Volumes
XX,X00	Estimated Daily Traffic Volume

**FIGURE 4**  
**LUCENT STATION**  
**DOUGLAS COUNTY, COLORADO**  
**2028 BACKGROUND TRAFFIC VOLUMES**



LEGEND	
(X)	Study Area Key Intersection
XXX(XXX)	Weekday AM(PM) Peak Hour Traffic Volumes
XX,X00	Estimated Daily Traffic Volume

**FIGURE 5**  
**LUCENT STATION**  
**DOUGLAS COUNTY, COLORADO**  
**2045 BACKGROUND TRAFFIC VOLUMES**

## 4.0 PROJECT TRAFFIC CHARACTERISTICS

### 4.1 Trip Generation

Site-generated traffic estimates are determined through a process known as trip generation. Rates and equations are applied to the proposed land use to estimate traffic generated by the development during a specific time interval. The acknowledged source for trip generation rates is the *Trip Generation Manual*<sup>1</sup> published by the Institute of Transportation Engineers (ITE). ITE has established trip rates in nationwide studies of similar land uses. For this study, Kimley-Horn used the ITE Trip Generation Manual average rate and fitted curve equations that applies to Single Family Attached Housing (ITE Land Use Code 215) and Multifamily Low-Rise Housing (ITE 220) for traffic associated with the development.

Lucent Station is expected to generate approximately 2,170 weekday daily trips, with 140 of these trips occurring during the morning peak hour and 175 occurring during the afternoon peak hour. Calculations were based on the procedure and information provided in the ITE Trip Generation Manual, 12<sup>th</sup> Edition – Volume 1: User’s Guide and Handbook, 2025. **Table 1** summarizes the estimated trip generation for the Lucent Station development. The trip generation worksheets are included in **Appendix D**.

**Table 1 – Lucent Station Traffic Generation**

Land Use and Size	Weekday Vehicle Trips						
	Daily	AM Peak Hour			PM Peak Hour		
		In	Out	Total	In	Out	Total
Single Family Attached Housing (ITE 215) – 84 Dwelling Units	552	9	25	34	23	17	40
Multifamily Low-Rise Housing (ITE 220) – 266 Dwelling Units	1,618	25	81	106	84	51	135
<b>Total Site Generated Trips 350 Dwelling Units</b>	<b>2,170</b>	<b>34</b>	<b>106</b>	<b>140</b>	<b>107</b>	<b>68</b>	<b>175</b>

<sup>1</sup> Institute of Transportation Engineers, *Trip Generation Manual*, Twelfth Edition, Washington DC, 2025.

## 4.2 Trip Distribution

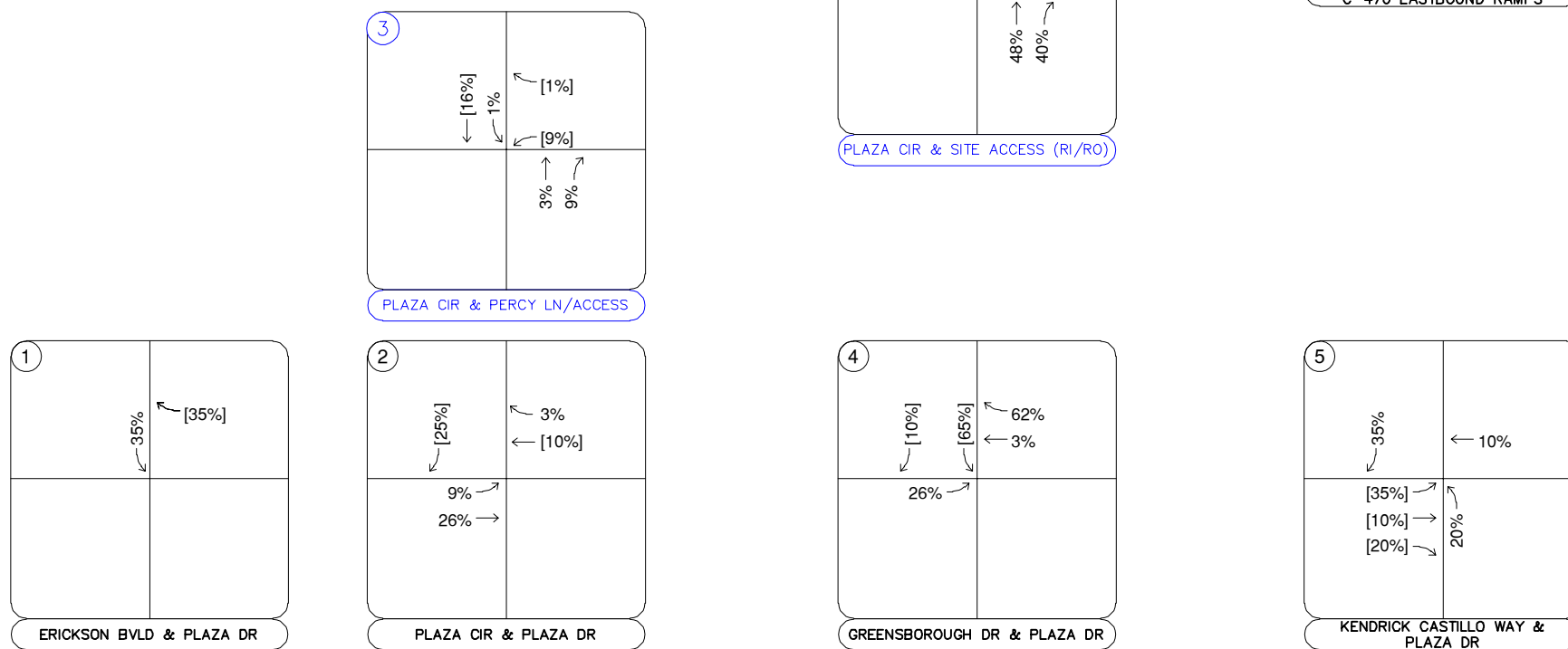
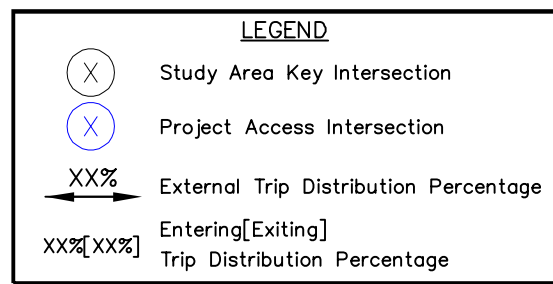
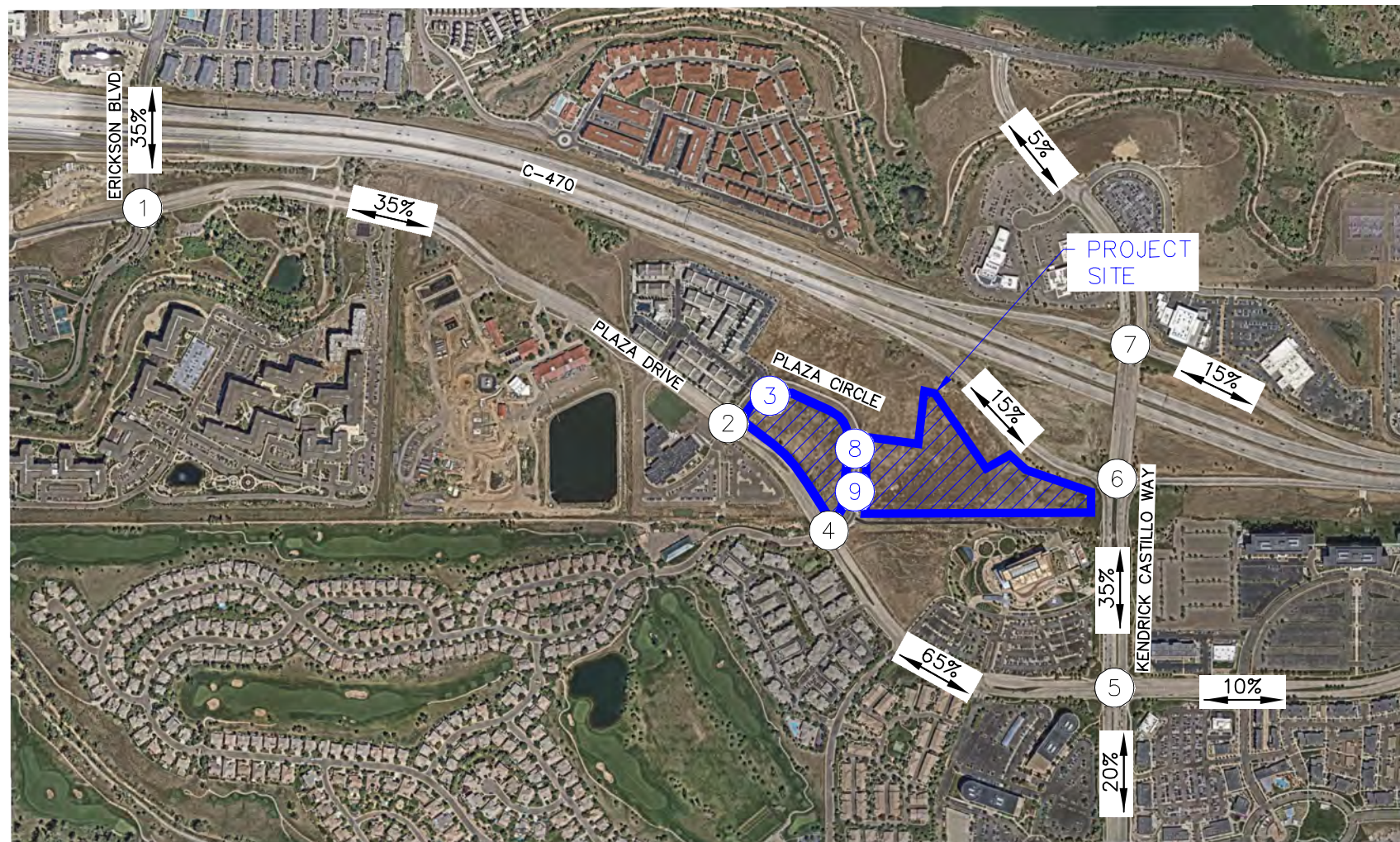
Distribution of site traffic on the street system was based on the area street system characteristics, existing traffic patterns, existing and anticipated surrounding demographic information, and the proposed access system for the project. The directional distribution of traffic is a means to quantify the percentage of site-generated traffic that approaches the site from a given direction and departs the site back to the original source. The project trip distribution for the proposed development is illustrated in **Figure 6**.

## 4.3 Traffic Assignment

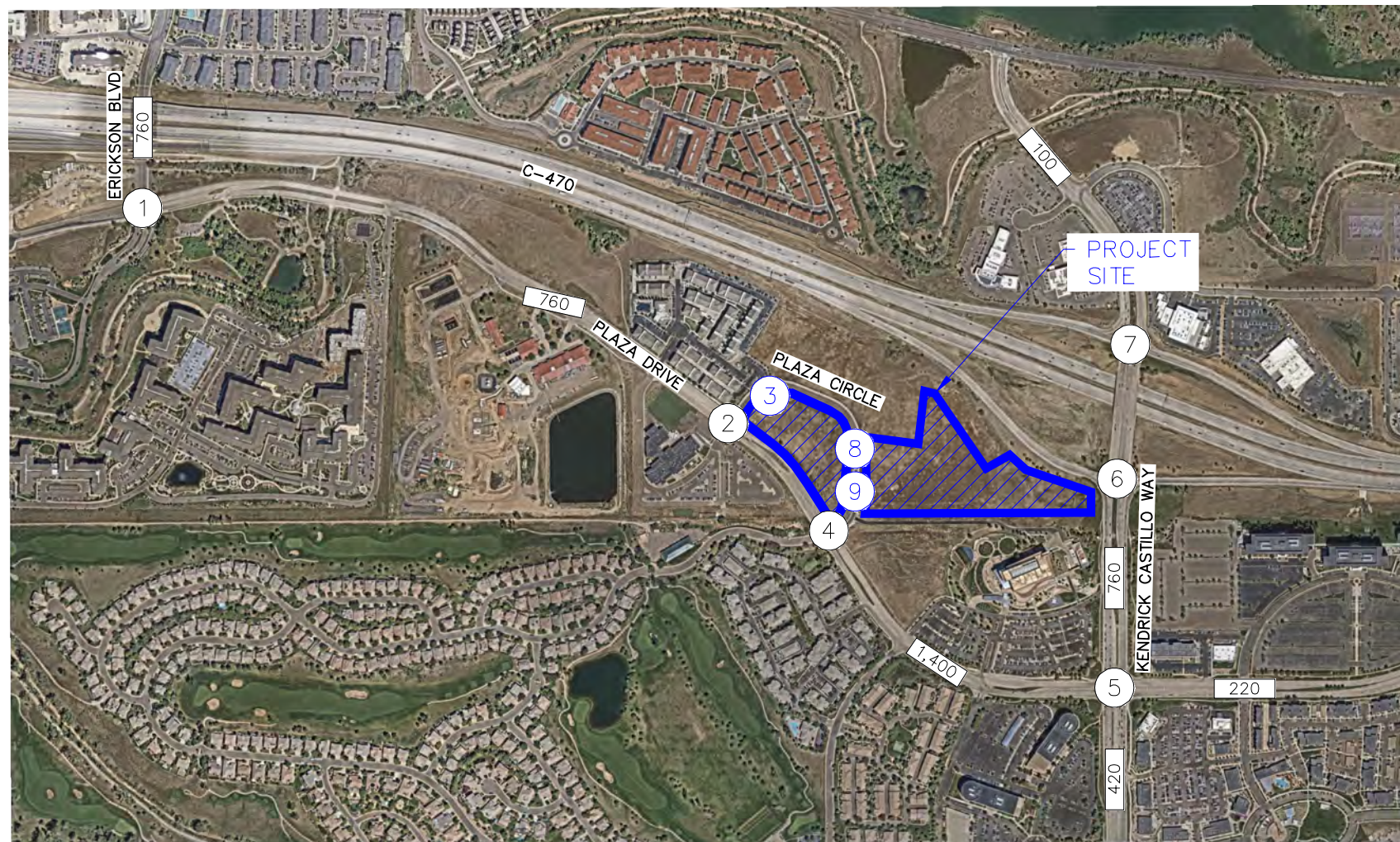
Lucent Station traffic assignment was obtained by applying the project trip distribution to the estimated traffic generation of the development shown in **Table 1**. Traffic assignment is shown in **Figure 7**.

## 4.4 Total (Background Plus Project) Traffic

Site traffic volumes were added to the background volumes to represent estimated traffic conditions for the short-term 2028 buildout horizon and long-term 2045 twenty-year planning horizon. These total traffic volumes for the study area are illustrated for the 2028 and 2045 horizon years in **Figure 8** and **Figure 9**, respectively.

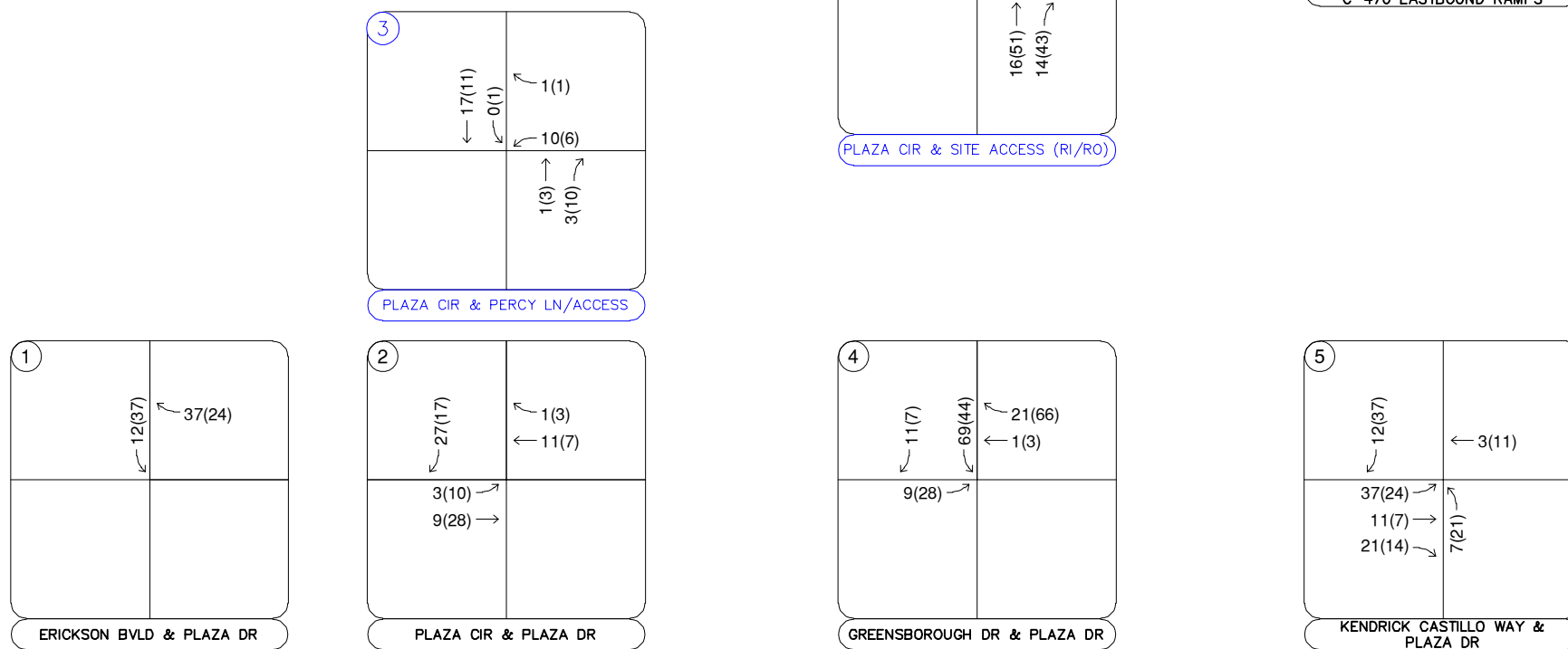


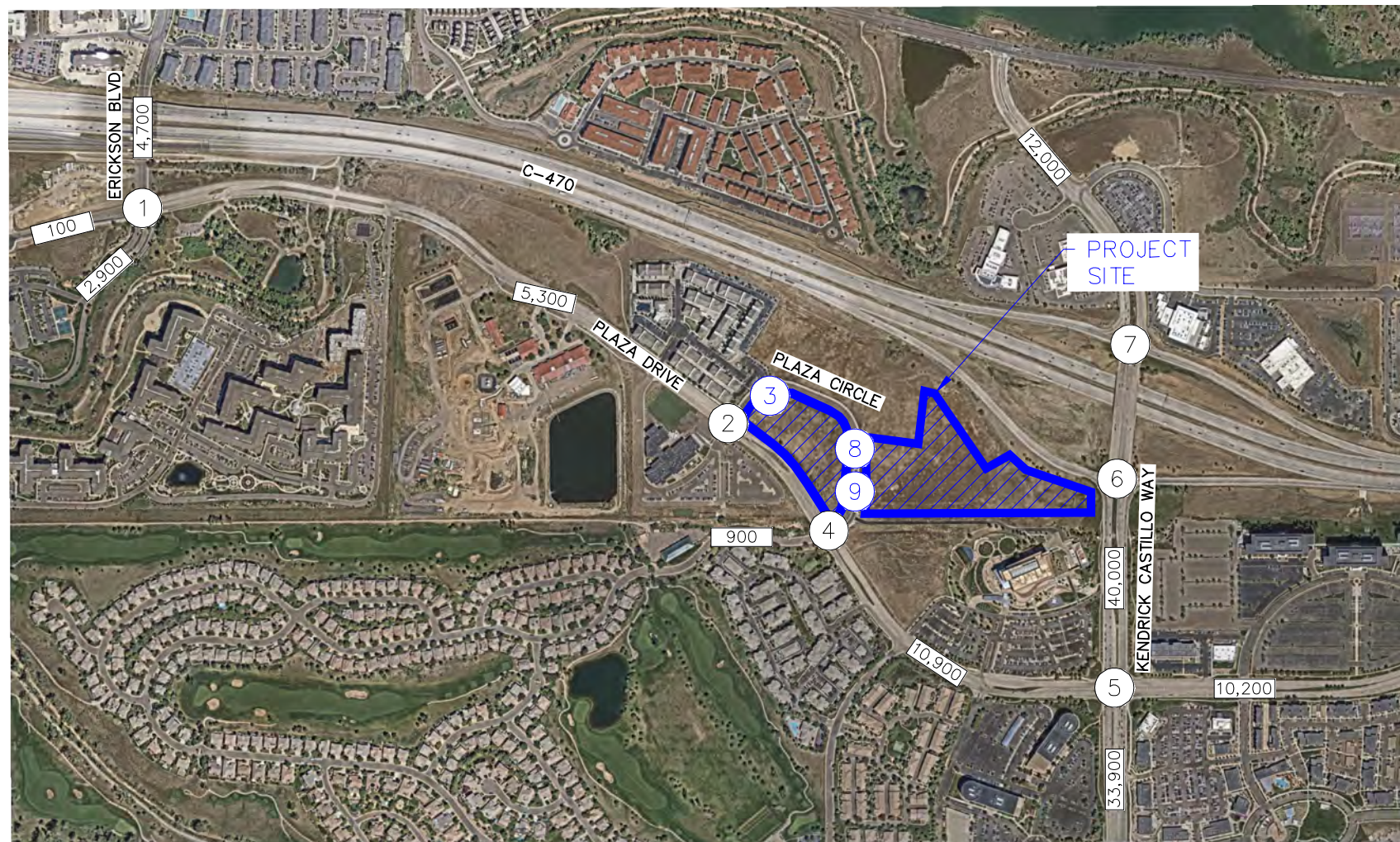
**FIGURE 6**  
LUCENT STATION  
DOUGLAS COUNTY, COLORADO  
PROJECT TRIP DISTRIBUTION



LEGEND	
(X)	Study Area Key Intersection
(X)	Project Access Intersection
xxx(xxx)	Weekday AM(PM) Peak Hour Traffic Volumes
xx,x00	Estimated Daily Traffic Volume

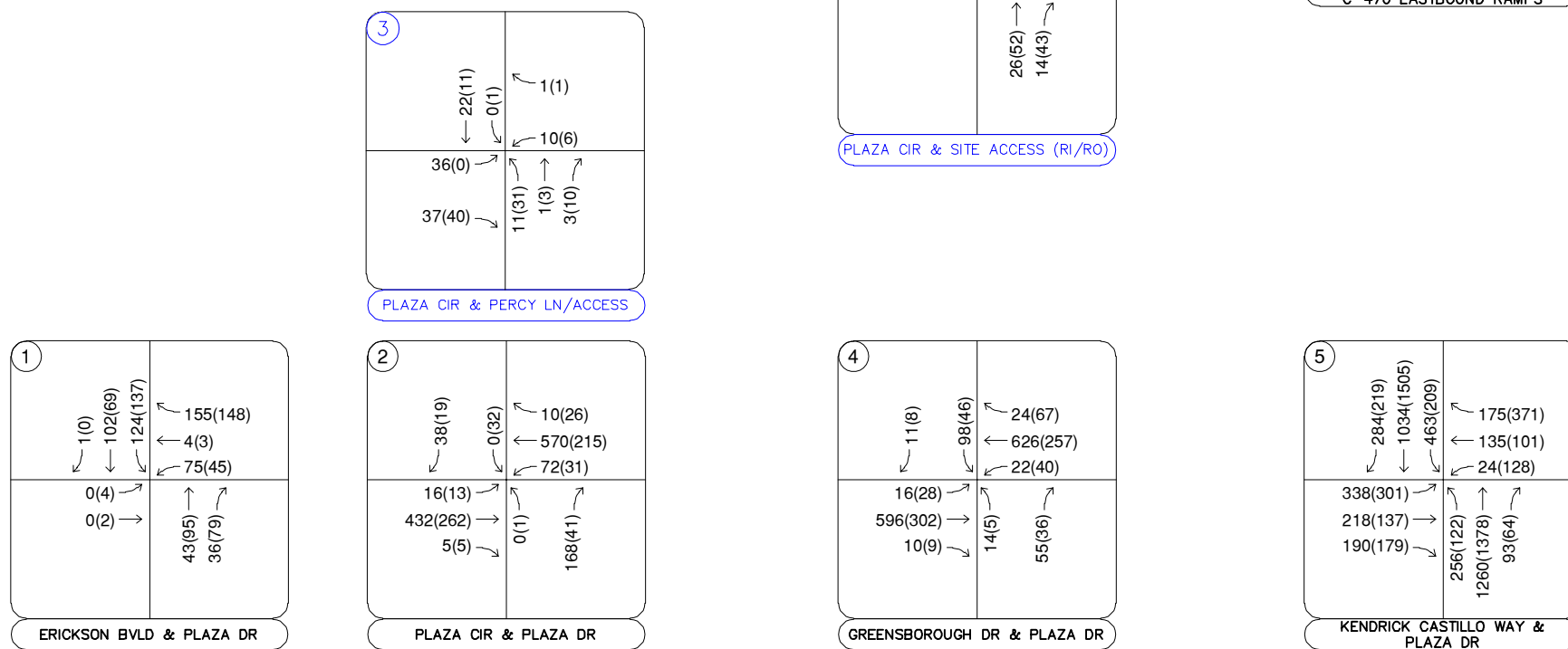
FIGURE 7  
LUCENT STATION  
DOUGLAS COUNTY, COLORADO  
PROJECT TRAFFIC ASSIGNMENT

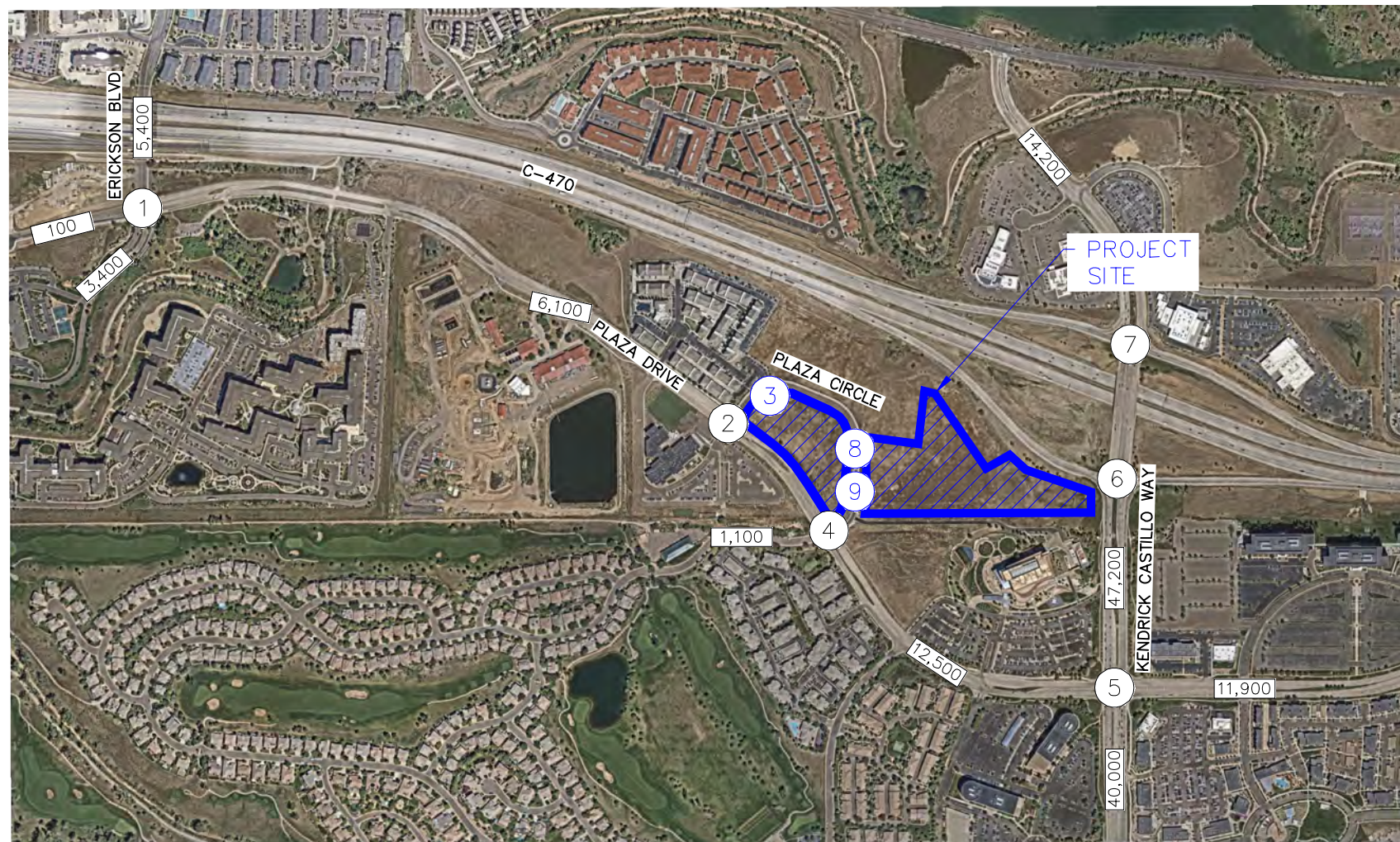




LEGEND	
(X)	Study Area Key Intersection
(X)	Project Access Intersection
xxx(xxx)	Weekday AM(PM)
xxx(xxx)	Peak Hour Traffic Volumes
xx,x00	Estimated Daily Traffic Volume

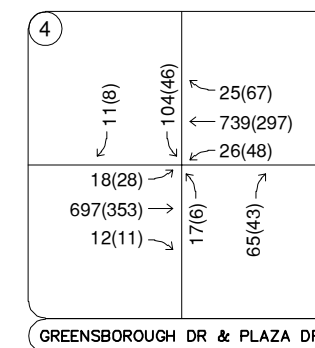
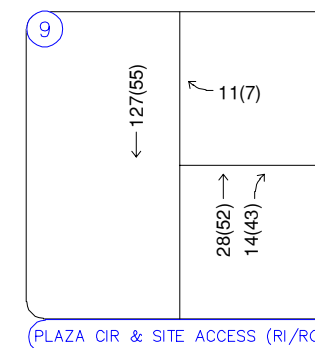
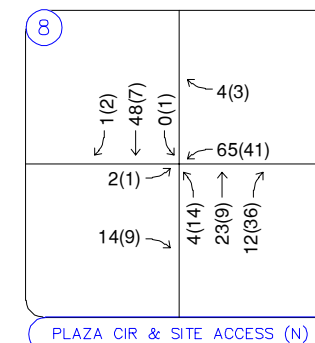
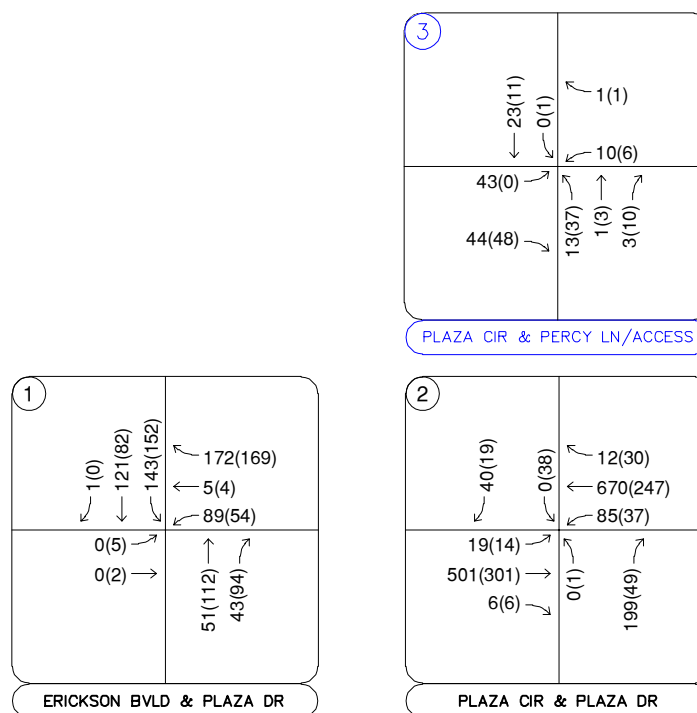
**FIGURE 8**  
**LUCENT STATION**  
**DOUGLAS COUNTY, COLORADO**  
**2028 TOTAL TRAFFIC VOLUMES**





LEGEND	
(X)	Study Area Key Intersection
(X)	Project Access Intersection
xxx(xxx)	Weekday AM(PM) Peak Hour Traffic Volumes
xx,x00	Estimated Daily Traffic Volume

**FIGURE 9**  
**LUCENT STATION**  
**DOUGLAS COUNTY, COLORADO**  
**2045 TOTAL TRAFFIC VOLUMES**



## 5.0 TRAFFIC OPERATIONS ANALYSIS

Kimley-Horn’s analysis of traffic operations in the site vicinity was conducted to determine potential capacity deficiencies in the 2028 and 2045 development horizons at the identified key intersections. The acknowledged source for determining overall capacity is the *Highway Capacity Manual (HCM)*<sup>2</sup>.

### 5.1 Analysis Methodology

Capacity analysis results are listed in terms of Level of Service (LOS). LOS is a qualitative term describing operating conditions a driver will experience while traveling on a particular street or highway during a specific time interval. It ranges from A (very little delay) to F (long delays and congestion). For intersections and roadways in this study area, standard traffic engineering practice recommends overall intersection LOS D and movement/approach LOS E as the minimum desirable thresholds for acceptable operations. **Table 2** shows the definition of level of service for signalized and unsignalized intersections.

**Table 2 – Level of Service Definitions**

Level of Service	Signalized Intersection Average Total Delay (sec/veh)	Unsignalized Intersection Average Total Delay (sec/veh)
A	≤ 10	≤ 10
B	> 10 and ≤ 20	> 10 and ≤ 15
C	> 20 and ≤ 35	> 15 and ≤ 25
D	> 35 and ≤ 55	> 25 and ≤ 35
E	> 55 and ≤ 80	> 35 and ≤ 50
F	> 80	> 50

Definitions provided from the Highway Capacity Manual, Seventh Edition, Transportation Research Board, 2022.

Study area intersections were analyzed based on average total delay analysis for signalized and unsignalized intersections. Under the unsignalized analysis, the LOS for a two-way stop-controlled intersection is determined by the computed or measured control delay and is defined for each minor movement. LOS for a two-way stop-controlled intersection is not defined for the whole intersection. LOS for signalized, roundabout, and all-way stop controlled intersections are defined for each approach and for the overall intersection.

<sup>2</sup> Transportation Research Board, *Highway Capacity Manual*, Seventh Edition, Washington DC, 2022.

## 5.2 Key Intersection Operational Analysis

Calculations for the operational level of service at the key intersections for the study area are provided in **Appendix E**. The existing year analysis is based on the lane geometry and intersection control shown in **Figure 2**. Existing peak hour factors were utilized in the analysis. The existing heavy vehicle percentages obtained from the turning movement counts were also used in each horizon year. The signalized intersection analysis utilizes the observed cycle lengths with optimized phasing and timing. Based on increased national attention given to establishing appropriate yellow and all-red clearance intervals to improve intersection safety, these have been calculated and are applied for approaches at the signalized intersections. The increase in yellow and all red time sacrifices intersection capacity for improved safety. Synchro traffic analysis software was used to analyze the signalized and unsignalized key intersections for HCM level of service.

### Erickson Boulevard/Mill Vista Road and Plaza Drive (#1)

The unsignalized intersection of Erickson Boulevard/Mill Vista Road and Plaza Drive operates with all-way stop control on all four approaches. The intersection operates acceptably at LOS A during both peak hours under existing conditions. With project traffic, the intersection is anticipated to continue operating at an acceptable LOS A in 2028 and LOS B in 2045 during both studied weekday peak hours. Therefore, no improvements or modifications are anticipated to be needed at this intersection based on the addition of project traffic and this operational analysis.

**Table 3** provides the results of the LOS analysis conducted at this intersection.

**Table 3 – Erickson Boulevard/Mill Vista Road & Plaza Drive LOS Results**

Scenario	AM Peak Hour		PM Peak Hour	
	Delay (sec/veh)	LOS	Delay (sec/veh)	LOS
<b>2025 Existing</b>	<b>9.1</b>	<b>A</b>	<b>8.9</b>	<b>A</b>
Eastbound Approach	0.0	-	8.9	A
Westbound Approach	9.0	A	8.6	A
Northbound Approach	9.0	A	9.4	A
Southbound Approach	9.3	A	8.8	A
<b>2028 Background</b>	<b>9.4</b>	<b>A</b>	<b>9.2</b>	<b>A</b>
Eastbound Approach	0.0	-	9.1	A
Westbound Approach	9.2	A	8.9	A
Northbound Approach	9.2	A	9.7	A
Southbound Approach	9.6	A	9.1	A
<b>2028 Background Plus Project</b>	<b>9.7</b>	<b>A</b>	<b>9.6</b>	<b>A</b>
Eastbound Approach	0.0	-	9.3	A
Westbound Approach	9.6	A	9.2	A
Northbound Approach	9.4	A	9.9	A
Southbound Approach	9.9	A	9.7	A
<b>2045 Background</b>	<b>10.0</b>	<b>A</b>	<b>9.8</b>	<b>A</b>
Eastbound Approach	0.0	-	9.4	A
Westbound Approach	9.8	A	9.3	A
Northbound Approach	9.8	A	10.5	A
Southbound Approach	10.2	A	9.5	A
<b>2045 Background Plus Project</b>	<b>10.3</b>	<b>B</b>	<b>10.2</b>	<b>B</b>
Eastbound Approach	0.0	-	9.6	A
Westbound Approach	10.1	B	9.8	A
Northbound Approach	10.0	B	10.9	B
Southbound Approach	10.6	B	10.1	B

## Plaza Circle and Plaza Drive (#2)

The unsignalized intersection of Plaza Circle and Plaza Drive operates with two-way stop control on the northbound and southbound approaches. All movements currently operate with acceptable level of service with exception of the southbound left turn movement during the morning peak hour. Of note, this poor level of service and need is based on existing traffic, mostly caused by the peaking traffic during the highest 15-minute interval due to Ben Franklin Academy. Although, this southbound left turn movement operates with long delays, the volume isn't high enough to warrant signalization. Therefore, to mitigate the long delay for the southbound left turn movement, a no left turn sign during the arrival and dismissal hours of the Ben Franklin Academy could be placed below the existing R1-1 STOP sign. This restriction would match the current restriction on the northbound approach, exiting the academy with a sign restricting the left turn movement onto Plaza Circle between 7:45-8:15 AM and 3:30-4:00 PM. Additionally, the Plaza Circle/Greensborough Drive (#4) and Plaza Drive intersection is recommended to be signalized. As such, this proposed traffic signal approximately 775 feet to the east of this intersection will provide more gaps in traffic by platooning westbound vehicles along Plaza Drive and can accommodate the rerouted left turning vehicles from Plaza Circle. (#3). Of note, the proposed left turn restriction is only applicable to the morning peak hour since the afternoon peak hour occurs outside of the school's dismissal period. With project traffic, the intersection is anticipated to have all movements operating at an acceptable during the studied weekday morning and afternoon peak hours throughout the 2045 horizon. **Table 4** provides the results of the LOS analysis conducted at this intersection.

**Table 4 – Plaza Circle & Plaza Drive LOS Results**

Scenario	AM Peak Hour		PM Peak Hour	
	Delay (sec/veh)	LOS	Delay (sec/veh)	LOS
<b>2025 Existing</b>				
Northbound Left	0.0	A	11.0	B
Northbound Right	13.5	B	9.1	A
Eastbound Left	9.9	A	7.6	A
Westbound Left	9.2	A	7.7	A
Southbound Left	48.2	E	11.5	B
Southbound Through/Right	11.6	B	8.8	A
<b>2028 Background</b>				
Northbound Left	0.0	A	11.4	B
Northbound Right	14.8	B	9.2	A
Eastbound Left	9.7	A	7.7	A
Westbound Left	9.7	A	7.8	A
Southbound Left	61.8	F	12.1	B
Southbound Through/Right	11.9	B	9.0	A
<b>2028 Background Plus Project</b>				
Northbound Left	0.0	A	11.9	B
Northbound Right	15.0	B	9.3	A
Eastbound Left	10.2	B	7.8	A
Westbound Left	9.7	A	7.9	A
Southbound Left	0.0	A	12.5	B
Southbound Through/Right	12.6	B	9.1	A
<b>2045 Background</b>				
Northbound Left	0.0	A	11.0	B
Northbound Right	18.5	C	9.1	A
Eastbound Left	11.0	B	7.6	A
Westbound Left	10.4	B	7.7	A
Southbound Left	220.5	F	11.5	B
Southbound Through/Right	12.9	B	8.8	A
<b>2045 Background Plus Project</b>				
Northbound Left	0.0	A	11.9	B
Northbound Right	18.9	C	9.5	A
Eastbound Left	10.3	B	7.7	A
Westbound Left	10.5	B	8.0	A
Southbound Left	0.0	A	12.4	B
Southbound Through/Right	9.9	A	8.6	A

#Restrict SB Left Turn Movement During AM

### Plaza Circle and Percy Lane/Project Access (#3)

The unsignalized T-intersection of Plaza Circle and Percy Lane operates with stop control on the eastbound Percy Lane approach. The intersection movements operate acceptably at LOS A during both peak hours under existing conditions. With project traffic the east leg of the intersection will be constructed and provide access to the site. A southbound left turn lane is recommended to be designated within the double-yellow full lane width median with a length of 50 feet at the proposed project access. It is recommended that the westbound exiting approach of the project access operate a single approach lane shared for all movements with a R1-1 “STOP” installed on this approach. As such, the intersection is anticipated to continue operating with all movements at an acceptable LOS A during both studied weekday peak hours throughout the 2045 horizon. **Table 5** provides the results of the LOS analysis conducted at this intersection.

**Table 5 – Plaza Circle & Percy Lane/Project Access LOS Results**

Scenario	AM Peak Hour		PM Peak Hour	
	Delay (sec/veh)	LOS	Delay (sec/veh)	LOS
<b>2025 Existing</b>				
Northbound Left	7.3	A	7.3	A
Eastbound Approach	8.6	A	8.4	A
<b>2028 Background</b>				
Northbound Left	7.3	A	7.3	A
Eastbound Approach	8.6	A	8.5	A
<b>2028 Background Plus Project</b>				
Northbound Left	7.4	A	7.3	A
Eastbound Approach	9.2	A	8.5	A
Westbound Approach	9.1	A	9.2	A
Southbound Left	-	A	7.2	A
<b>2045 Background</b>				
Northbound Left	7.3	A	7.3	A
Eastbound Approach	8.7	A	8.5	A
<b>2045 Background Plus Project</b>				
Northbound Left	7.4	A	7.3	A
Eastbound Approach	9.3	A	8.5	A
Westbound Approach	9.2	A	9.4	A
Southbound Left	-	A	7.2	A

#### **Plaza Circle/Greensborough Drive and Plaza Drive (#4)**

The unsignalized intersection of Greensborough Drive and Plaza Drive operates with two-way stop control on the northbound and southbound approaches. The intersection has all movements operating acceptably during both peak hours under existing conditions. With project traffic and the recommendation to restrict the southbound left turn movement during the arrival and dismissal time period at Plaza Drive and Plaza Circle (#3), the southbound left turn may operate with long delays during the peak hours. The restriction of the southbound left turn at Plaza Drive and Plaza Circle (#3) intersection will reroute traffic to this intersection. With the project traffic and reroute volumes, the intersection is anticipated to continue operating at an acceptable level of service during both studied weekday peak hours throughout the 2045 horizon with exception of the southbound left turn movement. An MUTCD Four Hour Signal Warrant was completed, and it was determined two out of the four hours meet warrant volumes. However, this intersection should be considered for signalization in the future. The signal warrant analysis worksheet is included in **Appendix G**. With signalization, this intersection is expected to operate at an acceptable LOS B or better during the morning and afternoon peak hours throughout 2045. **Table 6** provides the results of the LOS analysis conducted at this intersection.

**Table 6 – Greensborough Drive & Plaza Drive LOS Results**

Scenario	AM Peak Hour		PM Peak Hour	
	Delay (sec/veh)	LOS	Delay (sec/veh)	LOS
<b>2025 Existing</b>				
Northbound Approach	17.7	C	9.8	A
Eastbound Left	10.3	B	0.0	A
Westbound Left	10.1	B	8.0	A
Southbound Left	28.5	D	12.2	B
Southbound Through/Right	0.0	A	9.0	A
<b>2028 Background</b>				
Northbound Approach	19.7	C	10.0	B
Eastbound Left	10.6	B	0.0	A
Westbound Left	10.6	B	8.1	A
Southbound Left	31.5	D	12.8	B
Southbound Through/Right	0.0	A	9.1	A
<b>2028 Background Plus Project</b>				
Northbound Approach	20.5	C	10.1	B
Eastbound Left	10.9	B	8.1	A
Westbound Left	10.6	B	8.1	A
Southbound Left	219.6	F	15.1	C
Southbound Through/Right	12.7	B	9.4	A
<b>2028 Background Plus Project #</b>	15.2	B	10.0	A
<b>2045 Background</b>				
Northbound Approach	27.8	D	9.8	A
Eastbound Left	11.7	B	0.0	A
Westbound Left	11.7	B	8.0	A
Southbound Left	43.4	E	12.2	B
Southbound Through/Right	0.0	A	9.0	A
<b>2045 Background Plus Project #</b>	17.0	B	9.9	A

# Signalized

### Kendrick Castillo Way & Plaza Drive (#5)

The signalized intersection of Kendrick Castillo Way and Plaza Drive operates with protected-only left turn phasing on all four approaches. The intersection operates acceptably at LOS D during both the morning and afternoon peak hours under existing conditions. With project traffic, the intersection is anticipated to continue operating at an acceptable level of service of D during the two studied peak hours throughout the 2045 horizon. Of note, the future traffic conditions can sometimes report less delays than the existing condition when background and project traffic assignment volumes are added to movements that have less delay than the average intersection delay. Therefore, no improvements or modifications are anticipated to be needed at this intersection based on the addition of project traffic and this operational level of service analysis. **Table 7** provides the results of the LOS analysis conducted at this intersection.

**Table 7 – Kendrick Castillo Way & Plaza Drive LOS Results**

Scenario	AM Peak Hour		PM Peak Hour	
	Delay (sec/veh)	LOS	Delay (sec/veh)	LOS
<b>2025 Existing</b>	46.1	D	39.2	D
<b>2028 Background</b>	48.7	D	41.1	D
<b>2028 Background Plus Project</b>	46.0	D	42.6	D
<b>2045 Background</b>	53.5	D	49.7	D
<b>2045 Background Plus Project</b>	53.2	D	51.6	D

### Kendrick Castillo Way & C-470 Eastbound Ramps (#6)

The signalized intersection of Kendrick Castillo Way and C-470 eastbound ramps operates with protected-permissive left turn phasing on the southbound approach. The intersection operates acceptably at LOS B during the morning peak hour and LOS A during the afternoon peak hour under existing conditions. With project traffic, the intersection is anticipated to continue operating at an acceptable level of service of B during the morning peak hour and LOS A throughout the 2045 horizon. Therefore, no improvements or modifications are anticipated to be needed at this intersection based on the addition of project traffic and this operational level of service analysis.

**Table 8** provides the results of the LOS analysis conducted at this intersection.

**Table 8 – Kendrick Castillo Way & C-470 Eastbound Ramps LOS Results**

Scenario	AM Peak Hour		PM Peak Hour	
	Delay (sec/veh)	LOS	Delay (sec/veh)	LOS
<b>2025 Existing</b>	10.6	B	4.2	A
<b>2028 Background</b>	10.7	B	4.2	A
<b>2028 Background Plus Project</b>	10.7	B	4.2	A
<b>2045 Background</b>	7.6	B	4.7	A
<b>2045 Background Plus Project</b>	7.6	B	4.7	A

### Kendrick Castillo Way & C-470 Westbound Ramps (#7)

The signalized intersection of Kendrick Castillo Way and C-470 westbound ramps operates with protected-only left turn phasing on the northbound approach. The intersection operates acceptably at LOS C during both peak hours under existing conditions. With project traffic, the intersection is anticipated to continue operating at an acceptable level of service C during both studied weekday peak hours throughout 2028. In the 2045 horizon, the intersection is anticipated to continue operating at an acceptable level of service of C during the morning peak hour and LOS D. Therefore, no improvements or modifications are anticipated to be needed at this intersection based on the addition of project traffic and this operational level of service analysis. **Table 9** provides the results of the LOS analysis conducted at this intersection.

**Table 9 – Kendrick Castillo Way & C-470 Westbound Ramps LOS Results**

Scenario	AM Peak Hour		PM Peak Hour	
	Delay (sec/veh)	LOS	Delay (sec/veh)	LOS
2025 Existing	30.0	C	31.8	C
2028 Background	30.0	C	32.0	C
2028 Background Plus Project	30.0	C	32.3	C
2045 Background	30.2	C	33.8	C
2045 Background Plus Project	30.3	C	34.2	C

## Project Accesses

With completion of the Lucent Station project, a full movement access that aligns with the Percy Lane at Plaza Circle, two (2) full movement accesses and a right-in/right-out access will be provided along Plaza Circle. “STOP” (R1-1) signs are recommended to be installed on the exiting approaches of all four (4) accesses, out of the development. In addition, a R3-2 No Left Turn sign should be placed underneath the R1-1 “STOP” sign at the right-in/right-out (RIRO) access to the south of the east lot. A northbound left turn lane is recommended to be designated within the currently striped median of Plaza Circle for the full movement access to the west lot. **Table 10** provides the results of the level of service analysis for these project accesses. As shown in the table, the project access intersections along Plaza Circle are anticipated to have all movements operating with acceptable LOS A during the peak hours in both the buildout year 2028 and the 2045 long term horizons.

**Table 10 – Project Access Level of Service Results**

Intersection	2028 Total				2045 Total			
	AM Peak Hour		PM Peak Hour		AM Peak Hour		PM Peak Hour	
	Delay (sec/veh)	LOS	Delay (sec/veh)	LOS	Delay (sec/veh)	LOS	Delay (sec/veh)	LOS
<b>Site Access (#8)</b>								
Northbound Left	7.3	A	7.3	A	7.3	A	7.3	A
Eastbound Approach	8.6	A	8.4	A	8.7	A	8.4	A
Westbound Approach	9.4	A	9.2	A	9.5	A	9.2	A
Southbound Left	0.0	A	7.3	A	0.0	A	7.3	A
<b>Site Access RI/RO (#9)</b>								
Westbound Right	8.5	A	8.7	A	8.5	A	8.7	A

### 5.3 Vehicle Queuing Analysis

A vehicle queuing analysis was conducted for the study area intersections. The queuing analysis was performed using Synchro presenting the results of the 95<sup>th</sup> percentile queue lengths. Results are shown in the following **Table 11** with calculations provided within the level of service operational sheets of **Appendix D** for unsignalized intersections and **Appendix E** for signalized intersections.

**Table 11 – Turn Lane Queuing Analysis Results**

Intersection Turn Lane	Existing Turn Lane Length (feet)	2028 Calculated Queue (feet)	2028 Recommended Length (feet)	2045 Calculated Queue (feet)	2045 Recommended Length (feet)
<b>Erickson Blvd &amp; Plaza Dr (#1)</b>					
Eastbound Through/Right	150'	25'	150'	25'	150'
Westbound Left	275'	25'	275'	25'	275'
Westbound Right	C	25'	C	50'	C
Southbound Left	C	25'	C	50'	C
Southbound Right	200'	25'	200'	25'	200'
<b>Plaza Circle &amp; Plaza Dr (#2)</b>					
Eastbound Left	100'	25'	100'	25'	100'
Westbound Left	175'	25'	175'	25'	175'
Northbound Left	100'	25'	100'	25'	100'
Northbound Right	100'	75'	100'	100'	100'
Southbound Left	100'	25'	100'	25'	100'
<b>Plaza Circle &amp; Percy Ln (#3)</b>					
Northbound Left	50'	25'	50'	25'	50'
Southbound Left	DNE	25'	50'	25'	50'
<b>Greensborough Dr &amp; Plaza Dr (#4)</b>					
Eastbound Left	200'	25'	200'	25'	200'
Westbound Left	150'	25'	150'	25'	150'
Southbound Left	250'	114'	250'	119'	250'
<b>Kendrick Castillo Way &amp; Plaza Dr (#5)</b>					
Eastbound Left	300' DL	259'	300' DL	254'	300' DL
Westbound Left	225' DL	101'	225' DL	116'	225' DL
Westbound Right	C	335'	C	440'	C
Northbound Left	250'/275'	152'	250'/275'	212'	250'/275'
Southbound Left	250' DL	283' DL	300' DL	421' DL	425' DL
<b>Kendrick Castillo Way &amp; C-470 EB Ramp (#6)</b>					
Eastbound Left	C DL	89'	C DL	106'	C DL
Eastbound Right	100'	Free	100'	Free	100'
Northbound Right	C/975'	483'	C	319'	C
Southbound Left	550'	111'	550'	129'	550'
<b>Kendrick Castillo Way &amp; C-470 EB Ramp (#7)</b>					
Westbound Left	C DL	362'	C DL	481'	C DL
Westbound Right	250'	Free	250'	Free	250'
Northbound Left	C/625'	455'	C/625'	528'	C/625'
Southbound Right	500'	Free	500'	Free	500'
<b>Plaza Circle Full Access (#8)</b>					
Northbound Left	DNE	25'	50'	25'	50'
Southbound Left	DNE	25'	50'	25'	50'

DNE = Does Not Exist; C = Continuous; DL = Dual Lefts: **Red** Text = Storage Deficiency; **Blue** Text = Recommendation

All queues are anticipated to remain within the existing or recommended turn lane lengths with exception of the southbound left turns at the Kendrick Castillo Way & Plaza Drive (#5) intersection.

The dual southbound left turn lanes are recommended to be extended from 250 feet to 300 feet. This extension will require a median modification and may require additional length in 2045. Of note, extension of these dual left turn lanes is independent and not caused by Lucent Station. The new left turn lanes along Plaza Circle for the full movement accesses are recommended to provide a length of 50 feet by restriping the existing double-yellow full lane width median.

#### 5.4 Improvement Summary

Based on the results of the intersection operational and vehicle queuing analysis, the key intersection recommended improvements and control are shown in **Figure 10** with the conclusion recommendations provided in the next section.

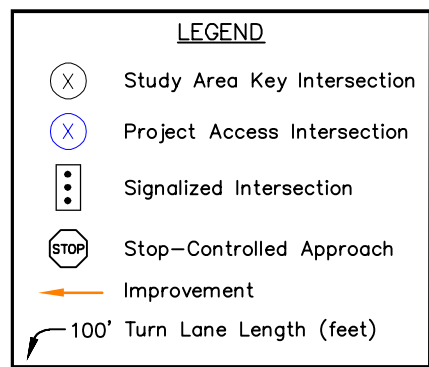
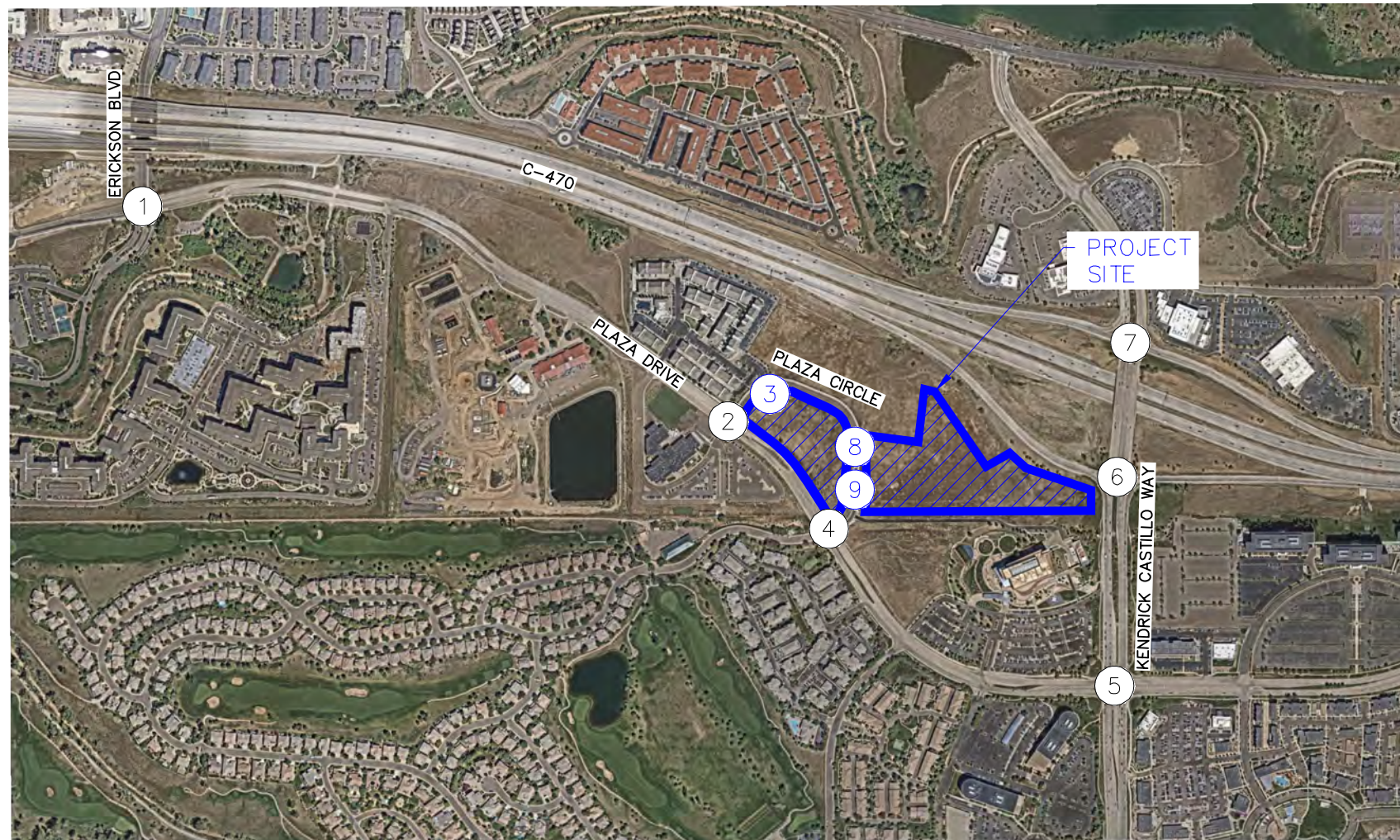
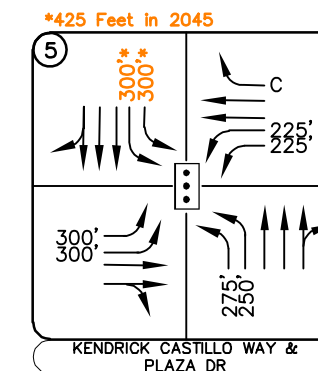
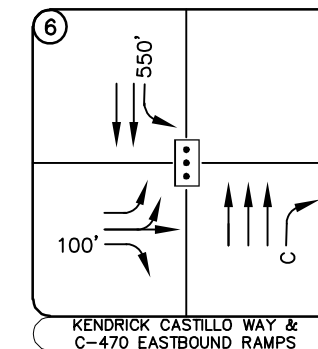
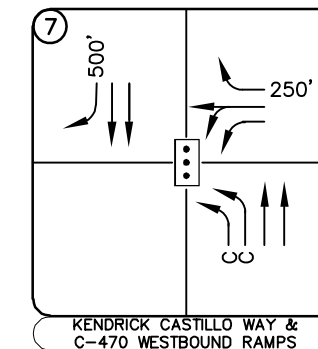
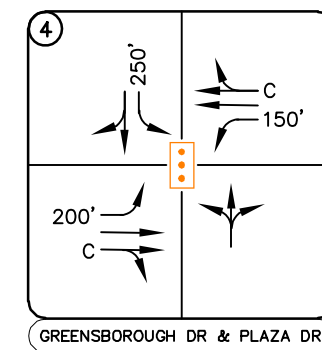
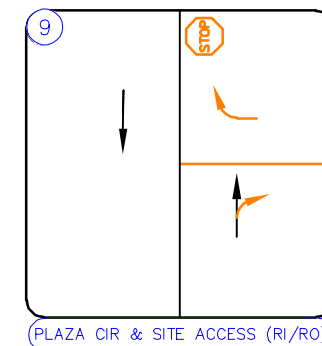
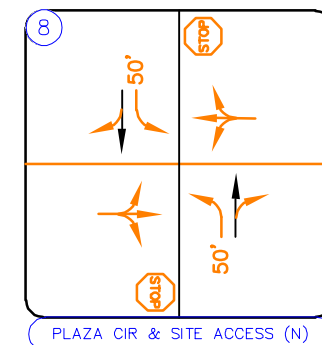
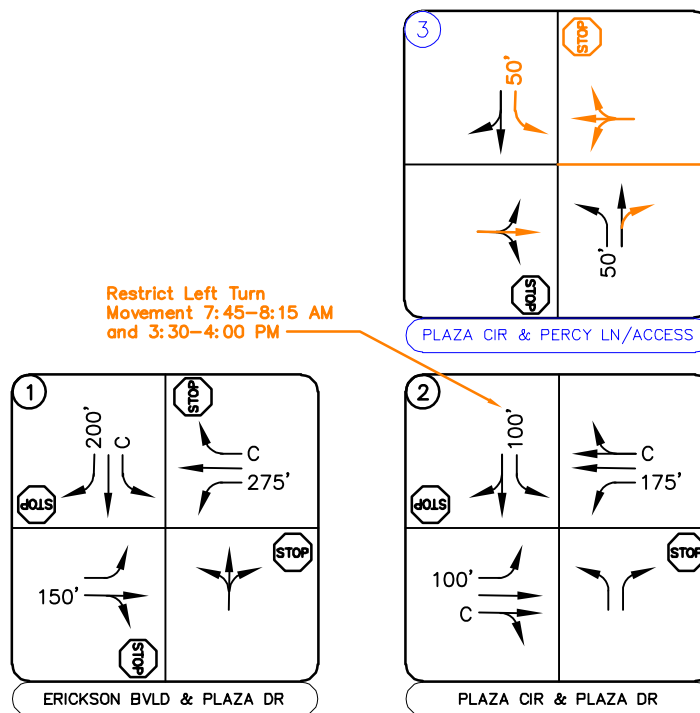


FIGURE 10  
LUCENT STATION  
DOUGLAS COUNTY, COLORADO  
RECOMMENDED GEOMETRY AND CONTROL



## 6.0 CONCLUSIONS AND RECOMMENDATIONS

---

Based on the analysis presented in this report, Kimley-Horn believes Lucent Station will be successfully incorporated into the existing and future roadway network. Analysis of the existing street network, the proposed project development, and expected traffic volumes resulted in the following conclusions and recommendations:

- It is recommended that the intersection of Plaza Circle/Greensborough Drive and Plaza Drive (#4) be signalized. This signalized intersection will likely also improve existing long southbound left turn delays at the Plaza Circle/Ben Franklin Academy and Plaza Drive intersection (#2). With signalization of the Plaza Circle/Greensborough Drive and Plaza Drive (#4) intersection, the southbound left movement at the Plaza Circle/Ben Franklin Academy and Plaza Drive intersection (#2) is recommended to be restricted during the arrival and dismissal times at the Ben Franklin Academy. This restriction would match the current restriction on the northbound approach, exiting the academy with a sign restricting the left turn movement onto Plaza Circle between 7:45-8:15 AM and 3:30-4:00 PM.
- It is recommended that the existing 250-foot southbound dual left turn lanes at the Kendrick Castillo Way and Plaza Drive (#5) intersection be extended to 300 feet in the short-term horizon and may need to be extended to 425 feet in 2045. Of note, extension of these dual left turn lanes is independent and not caused by Lucent Station.
- With completion of the Lucent Station project, a full movement access that aligns with the Percy Lane full movement access at Plaza Circle, two (2) full movement accesses in alignment with each other, and a right-in/right-out access will be provided along Plaza Circle. Left turn lanes are recommended to be designated within the double-yellow full lane width median for the Plaza Circle full movement accesses. These left turn lanes are recommended to be striped with lengths of 50 feet as is available. “STOP” (R1-1) signs are recommended to be installed on the approaches of all four (4) accesses, exiting the development. In addition, a R3-2 No Left Turn sign should be placed underneath the R1-1 “STOP” sign for the Plaza Circle right-in/right-out access.
- Any on-site or offsite improvements should be incorporated into the Civil Drawings and conform to standards of the Douglas County and the current edition of the Manual on Uniform Traffic Control Devices (MUTCD).

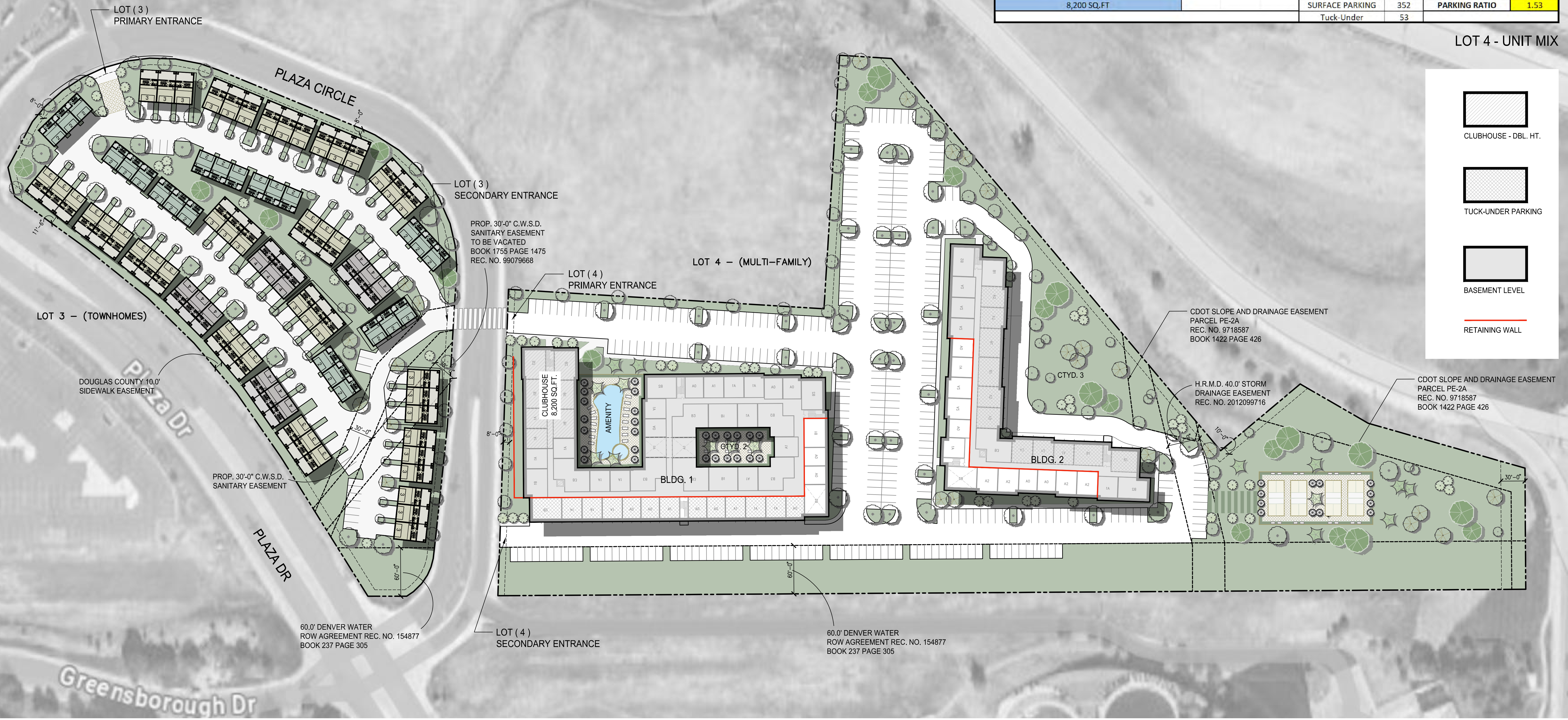
# Appendix A: Conceptual Site Plan


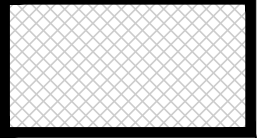


UNITS				TOTALS			
UNIT TYPE	DESCRIPTION	NET SQ. FT.	GROSS SQ. FT.	TOTAL NO. OF UNITS	UNIT %	NET SQ. FT. PER UNIT TYPE	GROSS SQ. FT. PER UNIT TYPE
B	2 BED / 2.5 BATH	1,274	1,734	24	28.6%	30,576	41,616
C	3 BED / 2.5 BATH	1,475	1,935	48	57.1%	70,800	92,880
D	4 BED / 2.5 BATH	1,722	2,182	12	14.3%	20,664	26,184
				<b>TOTAL</b>	<b>84</b>	<b>122,040</b>	<b>160,680</b>
AVERAGE UNIT SIZE					100%		
							1,453

LOT 3 - UNIT MIX

HIGHLANDS RANCH - UNIT MIX													
UNITS				BUILDING					UNIT %	NET SF TOTAL	GROSS SF TOTAL		
NAME	BEDS	NET	GROSS	SUB	LVL 1	LVL 2	LVL 3	TOTAL					
A0	1 BED	650	675	4	10	15	15	44	173	28600	29700		
A1	1 BED	725	750	12	17	26	26	81		58725	60750		
A2	1 BED	825	850	3	15	15	15	48		39600	40800		
									<b>66%</b>				
B1	2 BED	1060	1105	4	9	12	12	37	91	39220	40885		
B2	2 BED	1175	1225	4	4	9	9	26		30550	31850		
B3	2 BED + STUDY	1444	1494	7	7	7	7	28		40432	41832		
									<b>34%</b>				
<b>TOTAL</b>									<b>264</b>	<b>237127</b>	<b>245817</b>		
									<b>100%</b>				
AVERAGE UNIT SIZE													
898													
CLUBHOUSE													
8,200 SQ.FT													
									<b>PARKING TOTALS</b>		<b>TOTAL PARKING</b>	<b>405</b>	
									SURFACE PARKING		352	<b>PARKING RATIO</b>	<b>1.53</b>
									Tuck-Under		53		

LOT 4 - UNIT MIX



-  CLUBHOUSE - DBL. HT.
-  TUCK-UNDER PARKING
-  BASEMENT LEVEL
-  RETAINING WALL



1 SITE PLAN  
1"=60'-0"

# SITE PLAN - HIGHLANDS RANCH APARTMENTS

HIGHLANDS RANCH, CO - PAGERWEST

MEEKS PARTNERS  
16000 Memorial Drive  
Suite 100  
Houston, Texas 77079  
281558.8787

10.30.2025  
A-01  
JOB NO. 23095

Highlands Ranch Planned Development, 84th Amendment  
Project File: ZR2026-002  
Board of County Commissioners Staff Report - Page 100 of 292

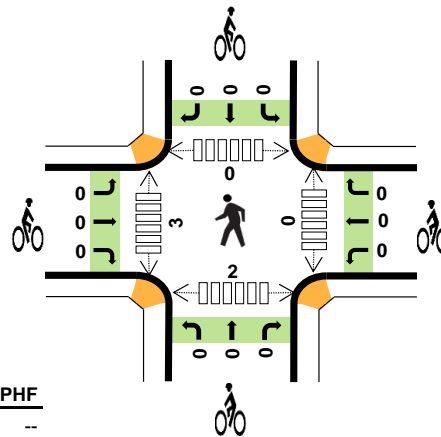
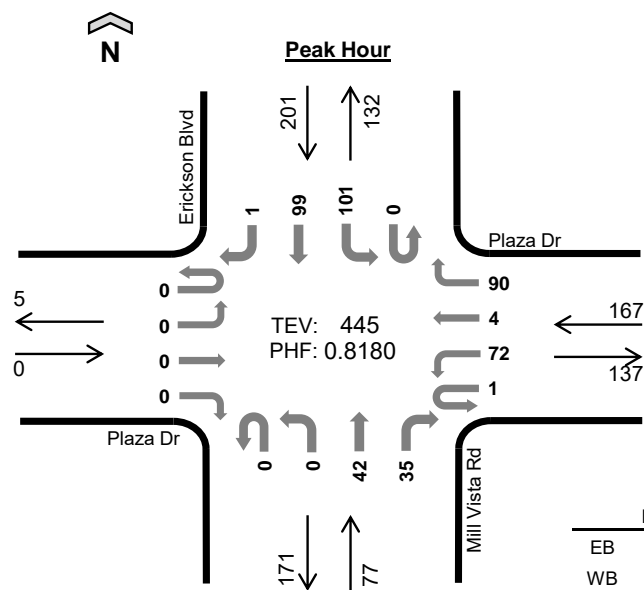
These are copyright and are subject to copyright protection as an "architectural work" under Section 102 of the Copyright Act, 17 U.S.C. as amended December 1, 1990, and known as the Architectural Works Protection Act of 1990. This protection includes but is not limited to, the overall form as well as the arrangement and composition of spaces and elements of the design, under such protection, unauthorized use of these plans, whether in whole or in part, for the construction of any building or structure, or the reproduction of these plans, whether in whole or in part, for the construction of any building or structure, is prohibited. © 2018 M+P, CO.

# Appendix B: Intersection Count Sheets

### Erickson Blvd Plaza Dr



Date: 1/22/2025  
 Count Period: 7:00 AM to 9:00 AM  
 Peak Hour: 7:45 AM to 8:45 AM



	HV%	PHF
EB	--	--
WB	2%	0.85
NB	4%	0.69
SB	2%	0.68
TOTAL	2%	0.82

#### Peak Hour Count Summaries

Peak Hour Interval Start	Plaza Dr				Plaza Dr				Mill Vista Rd				Erickson Blvd				15-min Total	Rolling Hour Total	
	Eastbound		Westbound		Northbound		Southbound		Northbound		Southbound								
	UT	LT	TH	RT	UT	LT	TH	RT	UT	LT	TH	RT	UT	LT	TH	RT			
7:45 AM	0	0	0	0	0	27	1	21	0	0	2	6	0	38	26	0	121	0	
8:00 AM	0	0	0	0	1	17	1	25	0	0	10	8	0	37	37	0	136	0	
8:15 AM	0	0	0	0	0	15	2	24	0	0	19	9	0	13	21	0	103	0	
8:30 AM	0	0	0	0	0	13	0	20	0	0	11	12	0	13	15	1	85	445	
Pk Hr	All	0	0	0	0	1	72	4	90	0	0	42	35	0	101	99	1	445	
	HV	0	0	0	0	0	1	0	3	0	0	2	1	0	1	3	0	11	
	HV%	-	-	-	-	0%	1%	0%	3%	-	-	5%	3%	-	1%	3%	0%	2%	

Note: For complete count summary (all intervals), see following pages.  
 \*\* Heavy Vehicle Classifications include FHWA Classes 4-13.  
 \*\* Count Summaries include heavy vehicles, but exclude bicycles in overall count.

Interval Start	Heavy Vehicle Totals					Bicycles					Pedestrians (Crossing Leg)				
	EB	WB	NB	SB	Total	EB	WB	NB	SB	Total	E	W	N	S	Total
7:45 AM	0	1	0	0	1	0	0	0	0	0	0	2	0	1	3
8:00 AM	0	0	2	1	3	0	0	0	0	0	0	1	0	1	2
8:15 AM	0	2	1	2	5	0	0	0	0	0	0	0	0	0	0
8:30 AM	0	1	0	1	2	0	0	0	0	0	0	0	0	0	0
Peak Hour	0	4	3	4	11	0	0	0	0	0	0	3	0	2	5

Count Summaries - All Vehicles																			
Interval Start	Plaza Dr				Plaza Dr				Mill Vista Rd				Erickson Blvd				15-min Total	Rolling Hour Total	
	Eastbound				Westbound				Northbound				Southbound						
	UT	LT	TH	RT	UT	LT	TH	RT	UT	LT	TH	RT	UT	LT	TH	RT			
7:00 AM	0	0	0	0	0	12	0	20	0	0	5	8	0	12	24	0	81	0	
7:15 AM	0	0	0	0	0	14	1	27	0	0	4	8	0	14	12	0	80	0	
7:30 AM	0	0	1	0	0	12	1	17	0	0	6	8	0	16	19	1	81	0	
7:45 AM	0	0	0	0	0	27	1	21	0	0	2	6	0	38	26	0	121	363	
8:00 AM	0	0	0	0	1	17	1	25	0	0	10	8	0	37	37	0	136	418	
8:15 AM	0	0	0	0	0	15	2	24	0	0	19	9	0	13	21	0	103	441	
8:30 AM	0	0	0	0	0	13	0	20	0	0	11	12	0	13	15	1	85	445	
8:45 AM	0	0	0	0	0	17	0	17	0	0	15	10	0	24	31	0	114	438	
Count Total	0	0	1	0	1	127	6	171	0	0	72	69	0	167	185	2	801		
Pk Hr	All	0	0	0	0	1	72	4	90	0	0	42	35	0	101	99	1	445	
	HV	0	0	0	0	0	1	0	3	0	0	2	1	0	1	3	0	11	
	HV%	-	-	-	-	0%	1%	0%	3%	-	-	5%	3%	-	1%	3%	0%	2%	

Interval Start	Heavy Vehicle Totals					Bicycles					Pedestrians (Crossing Leg)				
	EB	WB	NB	SB	Total	EB	WB	NB	SB	Total	E	W	N	S	Total
7:00 AM	0	1	1	2	4	0	0	0	0	0	0	0	0	1	1
7:15 AM	0	2	0	0	2	0	0	0	0	0	0	0	0	1	1
7:30 AM	0	1	1	2	4	0	0	0	0	0	0	0	0	0	0
7:45 AM	0	1	0	0	1	0	0	0	0	0	0	2	0	1	3
8:00 AM	0	0	2	1	3	0	0	0	0	0	0	1	0	1	2
8:15 AM	0	2	1	2	5	0	0	0	0	0	0	0	0	0	0
8:30 AM	0	1	0	1	2	0	0	0	0	0	0	0	0	0	0
8:45 AM	0	2	0	1	3	0	0	0	0	0	0	0	0	2	2
Count Total	0	10	5	9	24	0	0	0	0	0	0	3	0	6	9
Peak Hour	0	4	3	4	11	0	0	0	0	0	0	3	0	2	5

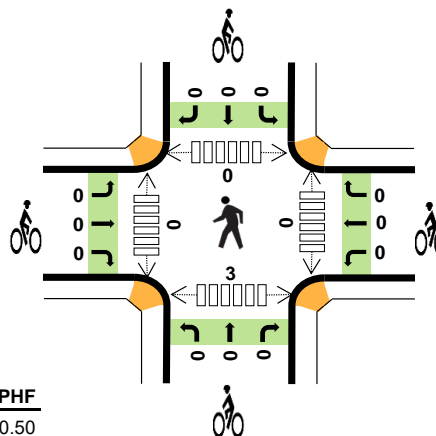
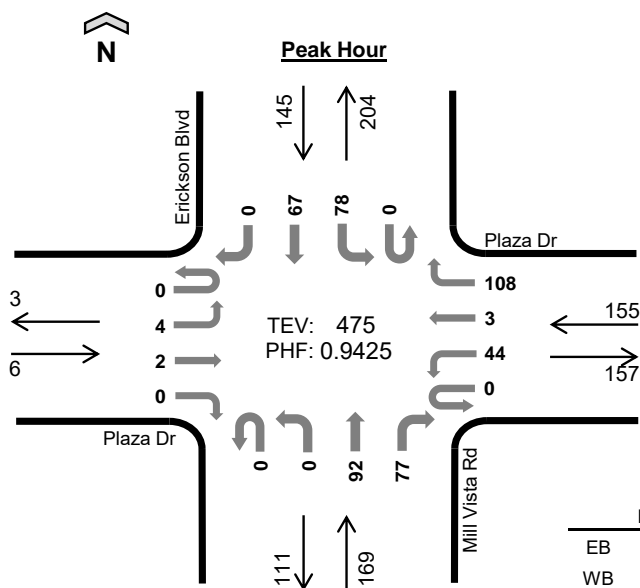
Count Summaries - Heavy Vehicles																			
Interval Start	Plaza Dr				Plaza Dr				Mill Vista Rd				Erickson Blvd				15-min Total	Rolling Hour Total	
	Eastbound				Westbound				Northbound				Southbound						
	UT	LT	TH	RT	UT	LT	TH	RT	UT	LT	TH	RT	UT	LT	TH	RT			
7:00 AM	0	0	0	0	0	1	0	0	0	0	0	0	1	0	0	2	0	4	0
7:15 AM	0	0	0	0	0	1	0	1	0	0	0	0	0	0	0	0	0	2	0
7:30 AM	0	0	0	0	0	1	0	0	0	0	0	0	1	0	1	1	0	4	0
7:45 AM	0	0	0	0	0	0	0	1	0	0	0	0	0	0	0	0	0	1	11
8:00 AM	0	0	0	0	0	0	0	0	0	0	1	1	0	0	0	1	0	3	10
8:15 AM	0	0	0	0	0	1	0	1	0	0	1	0	0	0	1	1	0	5	13
8:30 AM	0	0	0	0	0	0	0	1	0	0	0	0	0	0	0	1	0	2	11
8:45 AM	0	0	0	0	0	1	0	1	0	0	0	0	0	0	0	1	0	3	13
Count Total	0	0	0	0	0	5	0	5	0	0	2	3	0	2	7	0	24		
Pk Hr Heavy	0	0	0	0	0	1	0	3	0	0	2	1	0	1	3	0	11		

Count Summaries - Bikes																			
Interval Start	Plaza Dr				Plaza Dr				Mill Vista Rd				Erickson Blvd				15-min Total	Rolling Hour Total	
	Eastbound				Westbound				Northbound				Southbound						
	UT	LT	TH	RT	UT	LT	TH	RT	UT	LT	TH	RT	UT	LT	TH	RT			
7:00 AM	0	0	0	0	0	0	0	0	0	0	0	0	0	0	0	0	0	0	0
7:15 AM	0	0	0	0	0	0	0	0	0	0	0	0	0	0	0	0	0	0	0
7:30 AM	0	0	0	0	0	0	0	0	0	0	0	0	0	0	0	0	0	0	0
7:45 AM	0	0	0	0	0	0	0	0	0	0	0	0	0	0	0	0	0	0	0
8:00 AM	0	0	0	0	0	0	0	0	0	0	0	0	0	0	0	0	0	0	0
8:15 AM	0	0	0	0	0	0	0	0	0	0	0	0	0	0	0	0	0	0	0
8:30 AM	0	0	0	0	0	0	0	0	0	0	0	0	0	0	0	0	0	0	0
8:45 AM	0	0	0	0	0	0	0	0	0	0	0	0	0	0	0	0	0	0	0
Count Total	0	0	0	0	0	0	0	0	0	0	0	0	0	0	0	0	0	0	0
Pk Hr Bike	0	0	0	0	0	0	0	0	0	0	0	0	0	0	0	0	0	0	0

### Erickson Blvd Plaza Dr



Date: 1/22/2025  
 Count Period: 4:00 PM to 6:00 PM  
 Peak Hour: 4:00 PM to 5:00 PM



	HV%	PHF
EB	0%	0.50
WB	1%	0.86
NB	1%	0.77
SB	1%	0.81
TOTAL	1%	0.94

#### Peak Hour Count Summaries

Peak Hour Interval Start	Plaza Dr				Plaza Dr				Mill Vista Rd				Erickson Blvd				15-min Total	Rolling Hour Total	
	Eastbound		Westbound		Northbound		Southbound		Eastbound		Westbound								
	UT	LT	TH	RT	UT	LT	TH	RT	UT	LT	TH	RT	UT	LT	TH	RT			
4:00 PM	0	0	0	0	0	13	0	28	0	0	32	23	0	12	18	0	126	0	
4:15 PM	0	3	0	0	0	16	1	28	0	0	12	16	0	21	17	0	114	0	
4:30 PM	0	1	0	0	0	5	1	27	0	0	23	22	0	20	12	0	111	0	
4:45 PM	0	0	2	0	0	10	1	25	0	0	25	16	0	25	20	0	124	475	
Pk Hr	All	0	4	2	0	0	44	3	108	0	0	92	77	0	78	67	0	475	
	HV	0	0	0	0	0	0	0	2	0	0	0	2	0	0	1	0	5	
	HV%	-	0%	0%	-	-	0%	0%	2%	-	-	0%	3%	-	0%	1%	-	1%	

Note: For complete count summary (all intervals), see following pages.  
 \*\* Heavy Vehicle Classifications include FHWA Classes 4-13.  
 \*\* Count Summaries include heavy vehicles, but exclude bicycles in overall count.

Interval Start	Heavy Vehicle Totals					Bicycles					Pedestrians (Crossing Leg)				
	EB	WB	NB	SB	Total	EB	WB	NB	SB	Total	E	W	N	S	Total
4:00 PM	0	1	1	0	2	0	0	0	0	0	0	0	0	0	0
4:15 PM	0	1	0	1	2	0	0	0	0	0	0	0	0	0	0
4:30 PM	0	0	0	0	0	0	0	0	0	0	0	0	2	2	
4:45 PM	0	0	1	0	1	0	0	0	0	0	0	0	0	1	1
Peak Hour	0	2	2	1	5	0	0	0	0	0	0	0	0	3	3

Count Summaries - All Vehicles																			
Interval Start	Plaza Dr				Plaza Dr				Mill Vista Rd				Erickson Blvd				15-min Total	Rolling Hour Total	
	Eastbound				Westbound				Northbound				Southbound						
	UT	LT	TH	RT	UT	LT	TH	RT	UT	LT	TH	RT	UT	LT	TH	RT			
4:00 PM	0	0	0	0	0	13	0	28	0	0	32	23	0	12	18	0	126	0	
4:15 PM	0	3	0	0	0	16	1	28	0	0	12	16	0	21	17	0	114	0	
4:30 PM	0	1	0	0	0	5	1	27	0	0	23	22	0	20	12	0	111	0	
4:45 PM	0	0	2	0	0	10	1	25	0	0	25	16	0	25	20	0	124	475	
5:00 PM	0	0	1	0	0	9	0	29	0	0	24	18	0	12	16	0	109	458	
5:15 PM	0	0	0	0	0	10	1	24	0	0	19	20	0	15	8	0	97	441	
5:30 PM	0	0	1	0	0	5	0	31	0	0	15	11	0	12	16	0	91	421	
5:45 PM	0	0	0	0	0	6	0	18	0	0	14	15	0	15	11	0	79	376	
Count Total	0	4	4	0	0	74	4	210	0	0	164	141	0	132	118	0	851		
Pk Hr	All	0	4	2	0	0	44	3	108	0	0	92	77	0	78	67	0	475	
	HV	0	0	0	0	0	0	0	2	0	0	0	2	0	0	1	0	5	
	HV%	-	0%	0%	-	-	0%	0%	2%	-	-	0%	3%	-	0%	1%	-	1%	

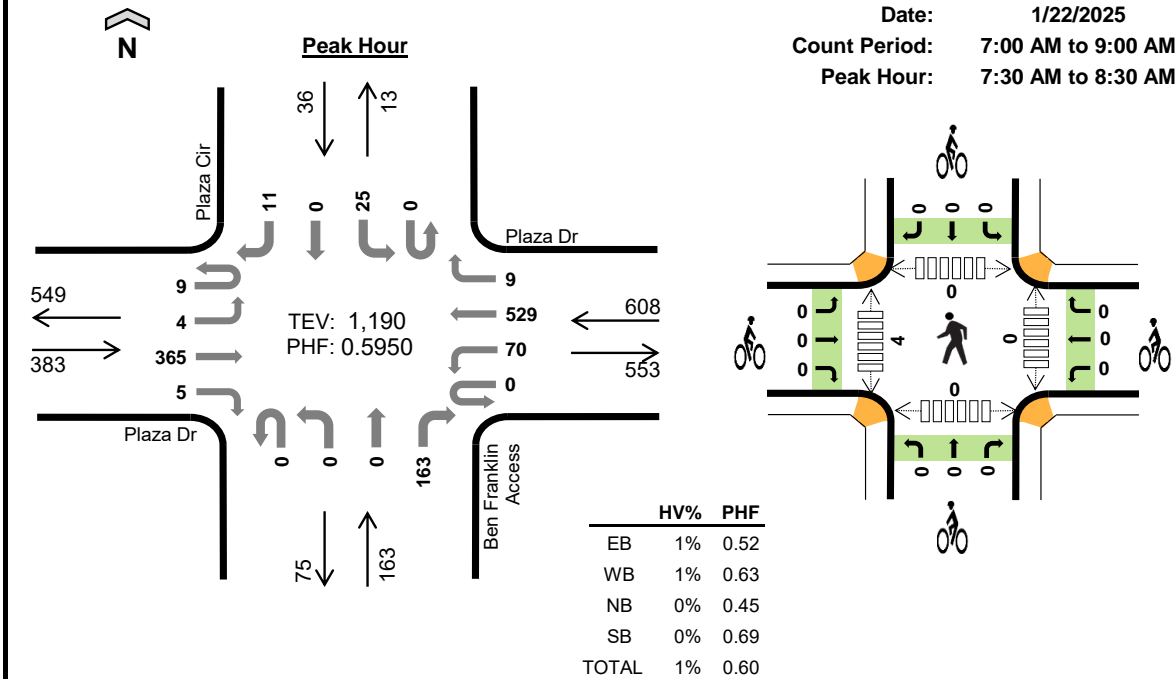
Interval Start	Heavy Vehicle Totals					Bicycles					Pedestrians (Crossing Leg)				
	EB	WB	NB	SB	Total	EB	WB	NB	SB	Total	E	W	N	S	Total
4:00 PM	0	1	1	0	2	0	0	0	0	0	0	0	0	0	0
4:15 PM	0	1	0	1	2	0	0	0	0	0	0	0	0	0	0
4:30 PM	0	0	0	0	0	0	0	0	0	0	0	0	0	2	2
4:45 PM	0	0	1	0	1	0	0	0	0	0	0	0	0	1	1
5:00 PM	0	0	0	0	0	0	0	0	0	0	0	3	0	3	6
5:15 PM	0	0	0	0	0	0	0	0	0	0	0	3	0	3	6
5:30 PM	0	0	0	0	0	0	0	0	0	0	0	0	0	0	0
5:45 PM	0	0	0	0	0	0	0	0	0	0	0	0	0	0	0
Count Total	0	2	2	1	5	0	0	0	0	0	0	6	0	9	15
Peak Hour	0	2	2	1	5	0	0	0	0	0	0	0	0	3	3

<b>Count Summaries - Heavy Vehicles</b>																		
Interval Start	Plaza Dr				Plaza Dr				Mill Vista Rd				Erickson Blvd				15-min Total	Rolling Hour Total
	Eastbound				Westbound				Northbound				Southbound					
	UT	LT	TH	RT	UT	LT	TH	RT	UT	LT	TH	RT	UT	LT	TH	RT		
4:00 PM	0	0	0	0	0	0	0	1	0	0	0	1	0	0	0	0	2	0
4:15 PM	0	0	0	0	0	0	0	1	0	0	0	0	0	0	1	0	2	0
4:30 PM	0	0	0	0	0	0	0	0	0	0	0	0	0	0	0	0	0	0
4:45 PM	0	0	0	0	0	0	0	0	0	0	0	1	0	0	0	0	1	5
5:00 PM	0	0	0	0	0	0	0	0	0	0	0	0	0	0	0	0	0	3
5:15 PM	0	0	0	0	0	0	0	0	0	0	0	0	0	0	0	0	0	1
5:30 PM	0	0	0	0	0	0	0	0	0	0	0	0	0	0	0	0	0	1
5:45 PM	0	0	0	0	0	0	0	0	0	0	0	0	0	0	0	0	0	0
Count Total	0	0	0	0	0	0	0	2	0	0	0	2	0	0	1	0	5	
Pk Hr Heavy	0	0	0	0	0	0	0	2	0	0	0	2	0	0	1	0	5	

<b>Count Summaries - Bikes</b>																		
Interval Start	Plaza Dr				Plaza Dr				Mill Vista Rd				Erickson Blvd				15-min Total	Rolling Hour Total
	Eastbound				Westbound				Northbound				Southbound					
	UT	LT	TH	RT	UT	LT	TH	RT	UT	LT	TH	RT	UT	LT	TH	RT		
4:00 PM	0	0	0	0	0	0	0	0	0	0	0	0	0	0	0	0	0	0
4:15 PM	0	0	0	0	0	0	0	0	0	0	0	0	0	0	0	0	0	0
4:30 PM	0	0	0	0	0	0	0	0	0	0	0	0	0	0	0	0	0	0
4:45 PM	0	0	0	0	0	0	0	0	0	0	0	0	0	0	0	0	0	0
5:00 PM	0	0	0	0	0	0	0	0	0	0	0	0	0	0	0	0	0	0
5:15 PM	0	0	0	0	0	0	0	0	0	0	0	0	0	0	0	0	0	0
5:30 PM	0	0	0	0	0	0	0	0	0	0	0	0	0	0	0	0	0	0
5:45 PM	0	0	0	0	0	0	0	0	0	0	0	0	0	0	0	0	0	0
Count Total	0	0	0	0	0	0	0	0	0	0	0	0	0	0	0	0	0	
Pk Hr Bike	0	0	0	0	0	0	0	0	0	0	0	0	0	0	0	0	0	



### Plaza Cir Plaza Dr



### Peak Hour Count Summaries

Peak Hour Interval Start	Plaza Dr				Plaza Dr				Ben Franklin Access				Plaza Cir				15-min Total	Rolling Hour Total	
	Eastbound		Westbound		Northbound		Southbound		Northbound		Southbound								
	UT	LT	TH	RT	UT	LT	TH	RT	UT	LT	TH	RT	UT	LT	TH	RT			
7:30 AM	0	0	30	2	0	26	69	1	0	0	0	5	0	6	0	0	139	0	
7:45 AM	2	2	116	0	0	6	230	7	0	0	0	49	0	9	0	4	425	0	
8:00 AM	4	2	174	3	0	18	197	1	0	0	0	91	0	3	0	7	500	0	
8:15 AM	3	0	45	0	0	20	33	0	0	0	0	18	0	7	0	0	126	1,190	
Pk Hr	All	9	4	365	5	0	70	529	9	0	0	163	0	25	0	11	1,190		
	HV	0	0	4	0	0	0	5	1	0	0	0	0	0	0	0	0	10	
	HV%	0%	0%	1%	0%	-	0%	1%	11%	-	-	-	0%	-	0%	-	0%	1%	

Note: For complete count summary (all intervals), see following pages.  
 \*\* Heavy Vehicle Classifications include FHWA Classes 4-13.  
 \*\* Count Summaries include heavy vehicles, but exclude bicycles in overall count.

Interval Start	Heavy Vehicle Totals					Bicycles					Pedestrians (Crossing Leg)				
	EB	WB	NB	SB	Total	EB	WB	NB	SB	Total	E	W	N	S	Total
7:30 AM	2	2	0	0	4	0	0	0	0	0	0	0	0	0	0
7:45 AM	1	1	0	0	2	0	0	0	0	0	0	0	0	0	0
8:00 AM	1	1	0	0	2	0	0	0	0	0	0	4	0	0	4
8:15 AM	0	2	0	0	2	0	0	0	0	0	0	0	0	0	0
Peak Hour	4	6	0	0	10	0	0	0	0	0	0	4	0	0	4

Count Summaries - All Vehicles																			
Interval Start	Plaza Dr				Plaza Dr				Ben Franklin Access				Plaza Cir				15-min Total	Rolling Hour Total	
	Eastbound				Westbound				Northbound				Southbound						
	UT	LT	TH	RT	UT	LT	TH	RT	UT	LT	TH	RT	UT	LT	TH	RT			
7:00 AM	0	0	24	2	0	13	33	0	0	1	0	4	0	7	0	1	85	0	
7:15 AM	0	0	20	1	0	19	40	0	0	0	0	1	0	15	0	0	96	0	
7:30 AM	0	0	30	2	0	26	69	1	0	0	0	5	0	6	0	0	139	0	
7:45 AM	2	2	116	0	0	6	230	7	0	0	0	49	0	9	0	4	425	745	
8:00 AM	4	2	174	3	0	18	197	1	0	0	0	91	0	3	0	7	500	1,160	
8:15 AM	3	0	45	0	0	20	33	0	0	0	0	18	0	7	0	0	126	1,190	
8:30 AM	0	0	21	2	0	7	41	2	0	0	0	1	0	7	0	0	81	1,132	
8:45 AM	0	0	26	0	0	10	30	1	0	1	0	2	0	11	0	1	82	789	
Count Total	9	4	456	10	0	119	673	12	0	2	0	171	0	65	0	13	1,534		
Pk Hr	All	9	4	365	5	0	70	529	9	0	0	0	163	0	25	0	11	1,190	
	HV	0	0	4	0	0	0	5	1	0	0	0	0	0	0	0	0	10	
	HV%	0%	0%	1%	0%	-	0%	1%	11%	-	-	-	0%	-	0%	-	0%	1%	

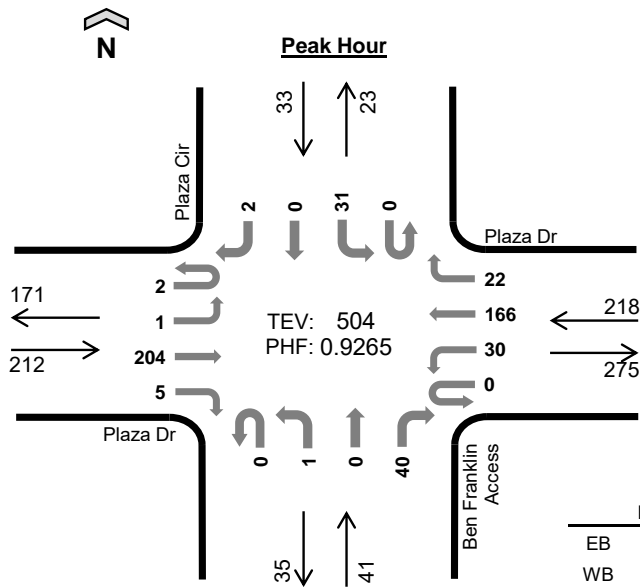
Interval Start	Heavy Vehicle Totals					Bicycles					Pedestrians (Crossing Leg)				
	EB	WB	NB	SB	Total	EB	WB	NB	SB	Total	E	W	N	S	Total
7:00 AM	0	1	0	0	1	0	0	0	0	0	0	0	0	0	0
7:15 AM	0	1	0	0	1	0	0	0	0	0	0	0	0	0	0
7:30 AM	2	2	0	0	4	0	0	0	0	0	0	0	0	0	0
7:45 AM	1	1	0	0	2	0	0	0	0	0	0	0	0	0	0
8:00 AM	1	1	0	0	2	0	0	0	0	0	0	4	0	0	4
8:15 AM	0	2	0	0	2	0	0	0	0	0	0	0	0	0	0
8:30 AM	0	1	0	0	1	0	0	0	0	0	2	0	1	0	3
8:45 AM	0	4	0	0	4	0	0	0	0	0	0	0	1	0	1
Count Total	4	13	0	0	17	0	0	0	0	0	2	4	2	0	8
Peak Hour	4	6	0	0	10	0	0	0	0	0	0	4	0	0	4

<b>Count Summaries - Heavy Vehicles</b>																		
Interval Start	Plaza Dr				Plaza Dr				Ben Franklin Access				Plaza Cir				15-min Total	Rolling Hour Total
	Eastbound				Westbound				Northbound				Southbound					
	UT	LT	TH	RT	UT	LT	TH	RT	UT	LT	TH	RT	UT	LT	TH	RT		
7:00 AM	0	0	0	0	0	0	1	0	0	0	0	0	0	0	0	0	1	0
7:15 AM	0	0	0	0	0	0	1	0	0	0	0	0	0	0	0	0	1	0
7:30 AM	0	0	2	0	0	0	2	0	0	0	0	0	0	0	0	0	4	0
7:45 AM	0	0	1	0	0	0	1	0	0	0	0	0	0	0	0	0	2	8
8:00 AM	0	0	1	0	0	0	0	1	0	0	0	0	0	0	0	0	2	9
8:15 AM	0	0	0	0	0	0	2	0	0	0	0	0	0	0	0	0	2	10
8:30 AM	0	0	0	0	0	0	1	0	0	0	0	0	0	0	0	0	1	7
8:45 AM	0	0	0	0	0	2	1	1	0	0	0	0	0	0	0	0	4	9
Count Total	0	0	4	0	0	2	9	2	0	0	0	0	0	0	0	0	17	
Pk Hr Heavy	0	0	4	0	0	0	5	1	0	0	0	0	0	0	0	0	10	

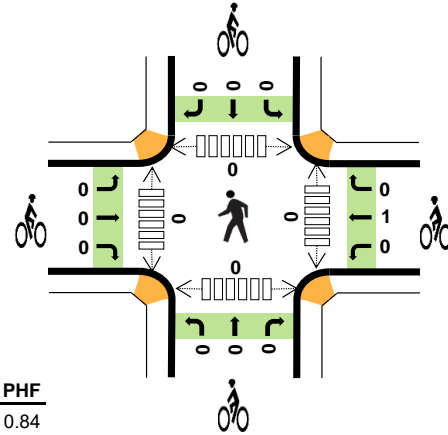
<b>Count Summaries - Bikes</b>																		
Interval Start	Plaza Dr				Plaza Dr				Ben Franklin Access				Plaza Cir				15-min Total	Rolling Hour Total
	Eastbound				Westbound				Northbound				Southbound					
	UT	LT	TH	RT	UT	LT	TH	RT	UT	LT	TH	RT	UT	LT	TH	RT		
7:00 AM	0	0	0	0	0	0	0	0	0	0	0	0	0	0	0	0	0	0
7:15 AM	0	0	0	0	0	0	0	0	0	0	0	0	0	0	0	0	0	0
7:30 AM	0	0	0	0	0	0	0	0	0	0	0	0	0	0	0	0	0	0
7:45 AM	0	0	0	0	0	0	0	0	0	0	0	0	0	0	0	0	0	0
8:00 AM	0	0	0	0	0	0	0	0	0	0	0	0	0	0	0	0	0	0
8:15 AM	0	0	0	0	0	0	0	0	0	0	0	0	0	0	0	0	0	0
8:30 AM	0	0	0	0	0	0	0	0	0	0	0	0	0	0	0	0	0	0
8:45 AM	0	0	0	0	0	0	0	0	0	0	0	0	0	0	0	0	0	0
Count Total	0	0	0	0	0	0	0	0	0	0	0	0	0	0	0	0	0	
Pk Hr Bike	0	0	0	0	0	0	0	0	0	0	0	0	0	0	0	0	0	



### Plaza Cir Plaza Dr



Date: 1/22/2025  
 Count Period: 4:00 PM to 6:00 PM  
 Peak Hour: 4:00 PM to 5:00 PM



	HV%	PHF
EB	0%	0.84
WB	2%	0.87
NB	0%	0.54
SB	12%	0.63
TOTAL	2%	0.93

### Peak Hour Count Summaries

Peak Hour Interval Start	Plaza Dr				Plaza Dr				Ben Franklin Access				Plaza Cir				15-min Total	Rolling Hour Total	
	Eastbound		Westbound		Northbound		Southbound		Northbound		Southbound								
	UT	LT	TH	RT	UT	LT	TH	RT	UT	LT	TH	RT	UT	LT	TH	RT			
4:00 PM	1	1	58	1	0	4	39	4	0	0	0	19	0	5	0	0	132	0	
4:15 PM	0	0	37	2	0	10	48	5	0	0	0	6	0	6	0	1	115	0	
4:30 PM	1	0	61	1	0	7	36	7	0	1	0	9	0	12	0	1	136	0	
4:45 PM	0	0	48	1	0	9	43	6	0	0	0	6	0	8	0	0	121	504	
Pk Hr	All	2	1	204	5	0	30	166	22	0	1	0	40	0	31	0	2	504	
	HV	0	0	0	1	0	0	3	1	0	0	0	0	0	4	0	0	9	
	HV%	0%	0%	0%	20%	-	0%	2%	5%	-	0%	-	0%	-	13%	-	0%	2%	

Note: For complete count summary (all intervals), see following pages.  
 \*\* Heavy Vehicle Classifications include FHWA Classes 4-13.  
 \*\* Count Summaries include heavy vehicles, but exclude bicycles in overall count.

Interval Start	Heavy Vehicle Totals					Bicycles					Pedestrians (Crossing Leg)				
	EB	WB	NB	SB	Total	EB	WB	NB	SB	Total	E	W	N	S	Total
4:00 PM	1	0	0	1	2	0	0	0	0	0	0	0	0	0	0
4:15 PM	0	1	0	1	2	0	0	0	0	0	0	0	0	0	0
4:30 PM	0	1	0	1	2	0	0	0	0	0	0	0	0	0	0
4:45 PM	0	2	0	1	3	0	1	0	0	1	0	0	0	0	0
Peak Hour	1	4	0	4	9	0	1	0	0	1	0	0	0	0	0

Count Summaries - All Vehicles																			
Interval Start	Plaza Dr				Plaza Dr				Ben Franklin Access				Plaza Cir				15-min Total	Rolling Hour Total	
	Eastbound				Westbound				Northbound				Southbound						
	UT	LT	TH	RT	UT	LT	TH	RT	UT	LT	TH	RT	UT	LT	TH	RT			
4:00 PM	1	1	58	1	0	4	39	4	0	0	0	19	0	5	0	0	132	0	
4:15 PM	0	0	37	2	0	10	48	5	0	0	0	6	0	6	0	1	115	0	
4:30 PM	1	0	61	1	0	7	36	7	0	1	0	9	0	12	0	1	136	0	
4:45 PM	0	0	48	1	0	9	43	6	0	0	0	6	0	8	0	0	121	504	
5:00 PM	0	0	42	0	0	2	39	8	0	1	0	7	0	11	0	0	110	482	
5:15 PM	0	0	33	2	0	6	45	7	0	2	0	3	0	8	1	0	107	474	
5:30 PM	0	0	25	0	0	9	37	9	0	3	0	12	0	2	0	0	97	435	
5:45 PM	0	1	32	2	0	2	28	6	0	0	0	1	0	6	0	1	79	393	
Count Total	2	2	336	9	0	49	315	52	0	7	0	63	0	58	1	3	897		
Pk Hr	All	2	1	204	5	0	30	166	22	0	1	0	40	0	31	0	2	504	
	HV	0	0	0	1	0	0	3	1	0	0	0	0	0	4	0	0	9	
	HV%	0%	0%	0%	20%	-	0%	2%	5%	-	0%	-	0%	-	13%	-	0%	2%	

Interval Start	Heavy Vehicle Totals					Bicycles					Pedestrians (Crossing Leg)				
	EB	WB	NB	SB	Total	EB	WB	NB	SB	Total	E	W	N	S	Total
4:00 PM	1	0	0	1	2	0	0	0	0	0	0	0	0	0	0
4:15 PM	0	1	0	1	2	0	0	0	0	0	0	0	0	0	0
4:30 PM	0	1	0	1	2	0	0	0	0	0	0	0	0	0	0
4:45 PM	0	2	0	1	3	0	1	0	0	1	0	0	0	0	0
5:00 PM	0	0	0	0	0	0	0	0	0	0	0	0	0	0	0
5:15 PM	0	0	0	0	0	0	0	0	0	0	0	1	0	1	2
5:30 PM	0	0	0	0	0	0	0	0	0	0	0	0	0	0	0
5:45 PM	1	0	0	0	1	0	0	0	0	0	0	0	0	0	0
Count Total	2	4	0	4	10	0	1	0	0	1	0	1	0	1	2
Peak Hour	1	4	0	4	9	0	1	0	0	1	0	0	0	0	0

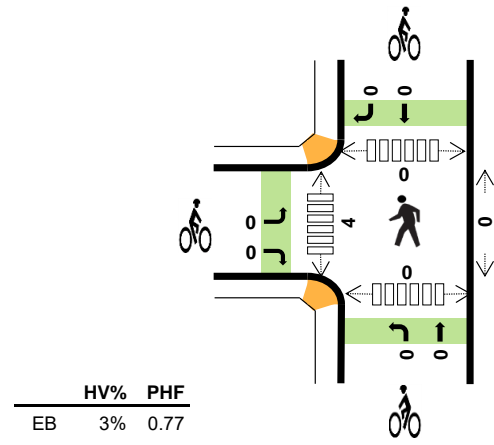
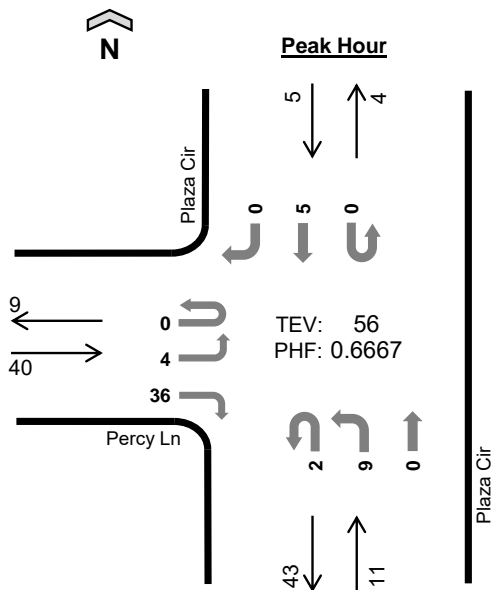
<b>Count Summaries - Heavy Vehicles</b>																		
Interval Start	Plaza Dr				Plaza Dr				Ben Franklin Access				Plaza Cir				15-min Total	Rolling Hour Total
	Eastbound				Westbound				Northbound				Southbound					
	UT	LT	TH	RT	UT	LT	TH	RT	UT	LT	TH	RT	UT	LT	TH	RT		
4:00 PM	0	0	0	1	0	0	0	0	0	0	0	0	0	1	0	0	2	0
4:15 PM	0	0	0	0	0	0	1	0	0	0	0	0	0	1	0	0	2	0
4:30 PM	0	0	0	0	0	0	0	1	0	0	0	0	1	0	0	2	0	
4:45 PM	0	0	0	0	0	0	2	0	0	0	0	0	1	0	0	3	9	
5:00 PM	0	0	0	0	0	0	0	0	0	0	0	0	0	0	0	0	7	
5:15 PM	0	0	0	0	0	0	0	0	0	0	0	0	0	0	0	0	5	
5:30 PM	0	0	0	0	0	0	0	0	0	0	0	0	0	0	0	0	3	
5:45 PM	0	0	1	0	0	0	0	0	0	0	0	0	0	0	0	1	1	
Count Total	0	0	1	1	0	0	3	1	0	0	0	0	0	4	0	0	10	
Pk Hr Heavy	0	0	0	1	0	0	3	1	0	0	0	0	0	4	0	0	9	

<b>Count Summaries - Bikes</b>																		
Interval Start	Plaza Dr				Plaza Dr				Ben Franklin Access				Plaza Cir				15-min Total	Rolling Hour Total
	Eastbound				Westbound				Northbound				Southbound					
	UT	LT	TH	RT	UT	LT	TH	RT	UT	LT	TH	RT	UT	LT	TH	RT		
4:00 PM	0	0	0	0	0	0	0	0	0	0	0	0	0	0	0	0	0	0
4:15 PM	0	0	0	0	0	0	0	0	0	0	0	0	0	0	0	0	0	0
4:30 PM	0	0	0	0	0	0	0	0	0	0	0	0	0	0	0	0	0	0
4:45 PM	0	0	0	0	0	0	1	0	0	0	0	0	0	0	0	1	1	
5:00 PM	0	0	0	0	0	0	0	0	0	0	0	0	0	0	0	0	1	
5:15 PM	0	0	0	0	0	0	0	0	0	0	0	0	0	0	0	0	1	
5:30 PM	0	0	0	0	0	0	0	0	0	0	0	0	0	0	0	0	1	
5:45 PM	0	0	0	0	0	0	0	0	0	0	0	0	0	0	0	0	0	
Count Total	0	0	0	0	0	0	1	0	0	0	0	0	0	0	0	0	1	
Pk Hr Bike	0	0	0	0	0	0	1	0	0	0	0	0	0	0	0	0	1	

### Plaza Cir Percy Ln



Date: 1/22/2025  
 Count Period: 7:00 AM to 9:00 AM  
 Peak Hour: 7:15 AM to 8:15 AM



	HV%	PHF
EB	3%	0.77
WB	--	--
NB	9%	0.34
SB	0%	0.31
TOTAL	4%	0.67

#### Peak Hour Count Summaries

Peak Hour Interval Start	Percy Ln				n/a				Plaza Cir				Plaza Cir				15-min Total	Rolling Hour Total	
	Eastbound				Westbound				Northbound				Southbound						
	UT	LT	TH	RT	UT	LT	TH	RT	UT	LT	TH	RT	UT	LT	TH	RT			
7:15 AM	0	0	0	13	0	0	0	0	0	0	0	0	0	0	0	0	13	0	
7:30 AM	0	0	0	8	0	0	0	0	0	1	0	0	0	0	0	0	9	0	
7:45 AM	0	2	0	10	0	0	0	0	2	6	0	0	0	0	1	0	21	0	
8:00 AM	0	2	0	5	0	0	0	0	0	2	0	0	0	0	4	0	13	56	
Pk Hr	All	0	4	0	36	0	0	0	0	2	9	0	0	0	0	5	0	56	
	HV	0	1	0	0	0	0	0	0	0	1	0	0	0	0	0	0	2	
	HV%	-	25%	-	0%	-	-	-	-	0%	11%	-	-	-	-	0%	-	4%	

Note: For complete count summary (all intervals), see following pages.  
 \*\* Heavy Vehicle Classifications include FHWA Classes 4-13.  
 \*\* Count Summaries include heavy vehicles, but exclude bicycles in overall count.

Interval Start	Heavy Vehicle Totals					Bicycles					Pedestrians (Crossing Leg)				
	EB	WB	NB	SB	Total	EB	WB	NB	SB	Total	E	W	N	S	Total
7:15 AM	0	0	0	0	0	0	0	0	0	0	0	2	0	0	2
7:30 AM	0	0	0	0	0	0	0	0	0	0	0	2	0	0	2
7:45 AM	0	0	0	0	0	0	0	0	0	0	0	0	0	0	0
8:00 AM	1	0	1	0	2	0	0	0	0	0	0	0	0	0	0
Peak Hour	1	0	1	0	2	0	0	0	0	0	0	4	0	0	4

Count Summaries - All Vehicles																		
Interval Start	Percy Ln				n/a				Plaza Cir				Plaza Cir				15-min Total	Rolling Hour Total
	Eastbound				Westbound				Northbound				Southbound					
	UT	LT	TH	RT	UT	LT	TH	RT	UT	LT	TH	RT	UT	LT	TH	RT		
7:00 AM	0	1	0	9	0	0	0	0	0	0	0	0	0	0	1	0	11	0
7:15 AM	0	0	0	13	0	0	0	0	0	0	0	0	0	0	0	0	13	0
7:30 AM	0	0	0	8	0	0	0	0	0	1	0	0	0	0	0	0	9	0
7:45 AM	0	2	0	10	0	0	0	0	2	6	0	0	0	0	1	0	21	54
8:00 AM	0	2	0	5	0	0	0	0	0	2	0	0	0	0	4	0	13	56
8:15 AM	0	0	0	6	0	0	0	0	1	0	0	0	0	0	0	0	7	50
8:30 AM	0	0	0	7	0	0	0	0	0	2	0	0	0	0	0	0	9	50
8:45 AM	0	0	0	10	0	0	0	0	0	1	0	0	0	0	1	0	12	41
Count Total	0	5	0	68	0	0	0	0	3	12	0	0	0	0	7	0	95	
Pk Hr	All	0	4	0	36	0	0	0	0	2	9	0	0	0	0	5	56	
	HV	0	1	0	0	0	0	0	0	0	1	0	0	0	0	0	2	
	HV%	-	25%	-	0%	-	-	-	-	0%	11%	-	-	-	-	0%	-	4%

Interval Start	Heavy Vehicle Totals					Bicycles					Pedestrians (Crossing Leg)				
	EB	WB	NB	SB	Total	EB	WB	NB	SB	Total	E	W	N	S	Total
7:00 AM	0	0	0	0	0	0	0	0	0	0	0	0	0	0	0
7:15 AM	0	0	0	0	0	0	0	0	0	0	0	2	0	0	2
7:30 AM	0	0	0	0	0	0	0	0	0	0	0	2	0	0	2
7:45 AM	0	0	0	0	0	0	0	0	0	0	0	0	0	0	0
8:00 AM	1	0	1	0	2	0	0	0	0	0	0	0	0	0	0
8:15 AM	0	0	0	0	0	0	0	0	0	0	0	0	0	0	0
8:30 AM	0	0	0	0	0	0	0	0	0	0	0	1	0	0	1
8:45 AM	0	0	1	0	1	0	0	0	0	0	0	0	0	0	0
Count Total	1	0	2	0	3	0	0	0	0	0	0	5	0	0	5
Peak Hour	1	0	1	0	2	0	0	0	0	0	0	4	0	0	4

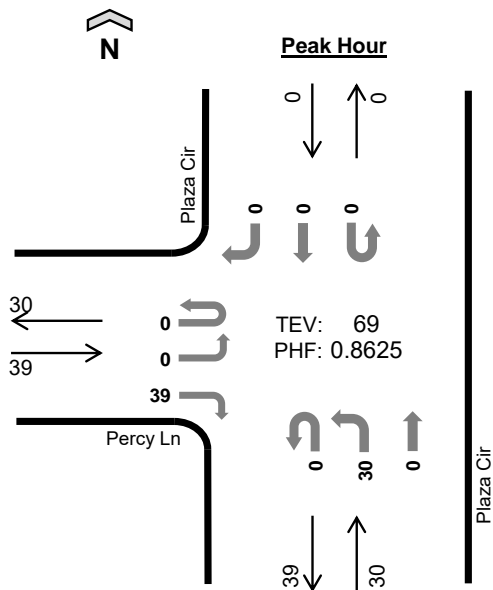
<b>Count Summaries - Heavy Vehicles</b>																		
Interval Start	Percy Ln				n/a				Plaza Cir				Plaza Cir				15-min Total	Rolling Hour Total
	Eastbound				Westbound				Northbound				Southbound					
	UT	LT	TH	RT	UT	LT	TH	RT	UT	LT	TH	RT	UT	LT	TH	RT		
7:00 AM	0	0	0	0	0	0	0	0	0	0	0	0	0	0	0	0	0	
7:15 AM	0	0	0	0	0	0	0	0	0	0	0	0	0	0	0	0	0	
7:30 AM	0	0	0	0	0	0	0	0	0	0	0	0	0	0	0	0	0	
7:45 AM	0	0	0	0	0	0	0	0	0	0	0	0	0	0	0	0	0	
8:00 AM	0	1	0	0	0	0	0	0	0	0	1	0	0	0	0	0	2	
8:15 AM	0	0	0	0	0	0	0	0	0	0	0	0	0	0	0	0	2	
8:30 AM	0	0	0	0	0	0	0	0	0	0	0	0	0	0	0	0	2	
8:45 AM	0	0	0	0	0	0	0	0	0	0	1	0	0	0	0	0	3	
Count Total	0	1	0	0	0	0	0	0	0	0	2	0	0	0	0	3		
Pk Hr Heavy	0	1	0	0	0	0	0	0	0	0	1	0	0	0	0	2		

<b>Count Summaries - Bikes</b>																		
Interval Start	Percy Ln				n/a				Plaza Cir				Plaza Cir				15-min Total	Rolling Hour Total
	Eastbound				Westbound				Northbound				Southbound					
	UT	LT	TH	RT	UT	LT	TH	RT	UT	LT	TH	RT	UT	LT	TH	RT		
7:00 AM	0	0	0	0	0	0	0	0	0	0	0	0	0	0	0	0	0	
7:15 AM	0	0	0	0	0	0	0	0	0	0	0	0	0	0	0	0	0	
7:30 AM	0	0	0	0	0	0	0	0	0	0	0	0	0	0	0	0	0	
7:45 AM	0	0	0	0	0	0	0	0	0	0	0	0	0	0	0	0	0	
8:00 AM	0	0	0	0	0	0	0	0	0	0	0	0	0	0	0	0	0	
8:15 AM	0	0	0	0	0	0	0	0	0	0	0	0	0	0	0	0	0	
8:30 AM	0	0	0	0	0	0	0	0	0	0	0	0	0	0	0	0	0	
8:45 AM	0	0	0	0	0	0	0	0	0	0	0	0	0	0	0	0	0	
Count Total	0	0	0	0	0	0	0	0	0	0	0	0	0	0	0	0		
Pk Hr Bike	0	0	0	0	0	0	0	0	0	0	0	0	0	0	0	0		

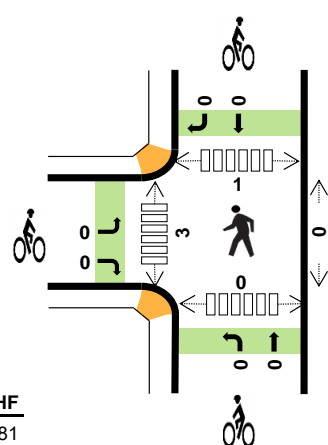
### Plaza Cir Percy Ln



Date: 1/22/2025  
 Count Period: 4:00 PM to 6:00 PM  
 Peak Hour: 4:30 PM to 5:30 PM



TEV: 69  
 PHF: 0.8625



	HV%	PHF
EB	5%	0.81
WB	--	--
NB	3%	0.83
SB	--	--
TOTAL	4%	0.86

#### Peak Hour Count Summaries

Peak Hour Interval Start	Percy Ln				n/a				Plaza Cir				Plaza Cir				15-min Total	Rolling Hour Total
	Eastbound				Westbound				Northbound				Southbound					
	UT	LT	TH	RT	UT	LT	TH	RT	UT	LT	TH	RT	UT	LT	TH	RT		
4:30 PM	0	0	0	12	0	0	0	0	0	8	0	0	0	0	0	0	20	0
4:45 PM	0	0	0	9	0	0	0	0	0	5	0	0	0	0	0	0	14	0
5:00 PM	0	0	0	8	0	0	0	0	0	8	0	0	0	0	0	0	16	0
5:15 PM	0	0	0	10	0	0	0	0	0	9	0	0	0	0	0	0	19	69
Pk Hr	All	0	0	0	39	0	0	0	0	0	30	0	0	0	0	0	69	
	HV	0	0	0	2	0	0	0	0	0	1	0	0	0	0	0	3	
	HV%	-	-	-	5%	-	-	-	-	-	3%	-	-	-	-	-	4%	

Note: For complete count summary (all intervals), see following pages.  
 \*\* Heavy Vehicle Classifications include FHWA Classes 4-13.  
 \*\* Count Summaries include heavy vehicles, but exclude bicycles in overall count.

Interval Start	Heavy Vehicle Totals					Bicycles					Pedestrians (Crossing Leg)				
	EB	WB	NB	SB	Total	EB	WB	NB	SB	Total	E	W	N	S	Total
4:30 PM	0	0	1	0	1	0	0	0	0	0	0	0	1	0	1
4:45 PM	2	0	0	0	2	0	0	0	0	0	0	0	0	0	0
5:00 PM	0	0	0	0	0	0	0	0	0	0	0	1	0	0	1
5:15 PM	0	0	0	0	0	0	0	0	0	0	0	2	0	0	2
Peak Hour	2	0	1	0	3	0	0	0	0	0	0	3	1	0	4

Count Summaries - All Vehicles																				
Interval Start	Percy Ln				n/a				Plaza Cir				Plaza Cir				15-min Total	Rolling Hour Total		
	Eastbound				Westbound				Northbound				Southbound							
	UT	LT	TH	RT	UT	LT	TH	RT	UT	LT	TH	RT	UT	LT	TH	RT				
4:00 PM	0	0	0	5	0	0	0	0	0	5	0	0	0	0	0	0	2	0	12	0
4:15 PM	0	0	0	5	0	0	0	0	0	0	4	0	0	0	0	0	1	0	10	0
<b>4:30 PM</b>	<b>0</b>	<b>0</b>	<b>0</b>	<b>12</b>	<b>0</b>	<b>0</b>	<b>0</b>	<b>0</b>	<b>0</b>	<b>0</b>	<b>8</b>	<b>0</b>	<b>0</b>	<b>0</b>	<b>0</b>	<b>0</b>	<b>0</b>	<b>20</b>	<b>0</b>	
4:45 PM	0	0	0	9	0	0	0	0	0	0	5	0	0	0	0	0	0	14	56	
5:00 PM	0	0	0	8	0	0	0	0	0	0	8	0	0	0	0	0	0	16	60	
5:15 PM	0	0	0	10	0	0	0	0	0	0	9	0	0	0	0	0	0	19	69	
5:30 PM	0	0	0	3	0	0	0	0	0	0	9	0	0	0	0	0	0	12	61	
5:45 PM	0	0	0	6	0	0	0	0	0	0	6	0	0	0	0	0	0	12	59	
Count Total	0	0	0	58	0	0	0	0	0	0	54	0	0	0	0	3	0	115		
Pk Hr	All	0	0	0	39	0	0	0	0	0	30	0	0	0	0	0	0	69		
	HV	0	0	0	2	0	0	0	0	0	1	0	0	0	0	0	0	3		
	HV%	-	-	-	5%	-	-	-	-	-	3%	-	-	-	-	-	-	4%		

Interval Start	Heavy Vehicle Totals					Bicycles					Pedestrians (Crossing Leg)				
	EB	WB	NB	SB	Total	EB	WB	NB	SB	Total	E	W	N	S	Total
4:00 PM	0	0	0	1	1	0	0	0	0	0	0	0	0	0	0
4:15 PM	0	0	0	1	1	0	0	0	0	0	0	0	0	0	0
<b>4:30 PM</b>	<b>0</b>	<b>0</b>	<b>1</b>	<b>0</b>	<b>1</b>	<b>0</b>	<b>0</b>	<b>0</b>	<b>0</b>	<b>0</b>	<b>0</b>	<b>0</b>	<b>1</b>	<b>0</b>	<b>1</b>
4:45 PM	2	0	0	0	2	0	0	0	0	0	0	0	0	0	0
5:00 PM	0	0	0	0	0	0	0	0	0	0	0	1	0	0	1
5:15 PM	0	0	0	0	0	0	0	0	0	0	0	2	0	0	2
5:30 PM	0	0	0	0	0	0	0	0	0	0	0	4	0	0	4
5:45 PM	0	0	0	0	0	0	0	0	0	0	0	1	0	0	1
Count Total	2	0	1	2	5	0	0	0	0	0	0	8	1	0	9
Peak Hour	2	0	1	0	3	0	0	0	0	0	0	3	1	0	4

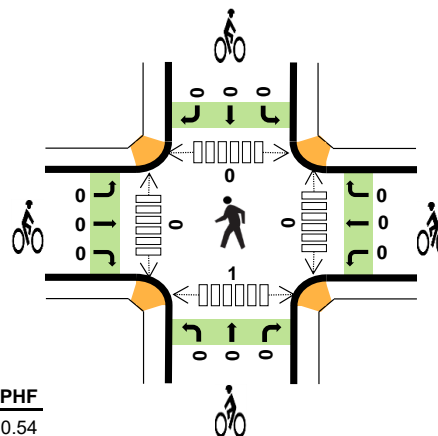
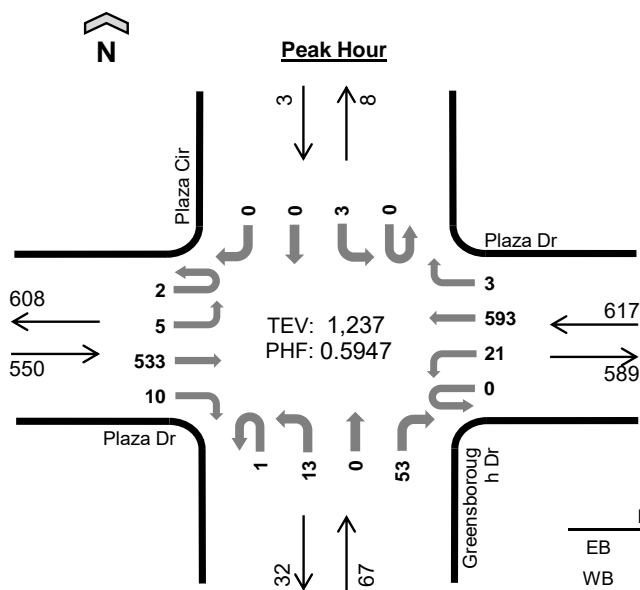
Count Summaries - Heavy Vehicles																		
Interval Start	Percy Ln				n/a				Plaza Cir				Plaza Cir				15-min Total	Rolling Hour Total
	Eastbound				Westbound				Northbound				Southbound					
	UT	LT	TH	RT	UT	LT	TH	RT	UT	LT	TH	RT	UT	LT	TH	RT		
4:00 PM	0	0	0	0	0	0	0	0	0	0	0	0	0	0	0	1	0	0
4:15 PM	0	0	0	0	0	0	0	0	0	0	0	0	0	0	0	1	0	0
<b>4:30 PM</b>	<b>0</b>	<b>0</b>	<b>0</b>	<b>0</b>	<b>0</b>	<b>0</b>	<b>0</b>	<b>0</b>	<b>0</b>	<b>1</b>	<b>0</b>	<b>0</b>	<b>0</b>	<b>0</b>	<b>0</b>	<b>1</b>	<b>0</b>	<b>0</b>
4:45 PM	0	0	0	2	0	0	0	0	0	0	0	0	0	0	0	2	0	5
5:00 PM	0	0	0	0	0	0	0	0	0	0	0	0	0	0	0	0	0	4
5:15 PM	0	0	0	0	0	0	0	0	0	0	0	0	0	0	0	0	0	3
5:30 PM	0	0	0	0	0	0	0	0	0	0	0	0	0	0	0	0	0	2
5:45 PM	0	0	0	0	0	0	0	0	0	0	0	0	0	0	0	0	0	0
Count Total	0	0	0	2	0	0	0	0	0	1	0	0	0	0	2	0	5	
<b>Pk Hr Heavy</b>	<b>0</b>	<b>0</b>	<b>0</b>	<b>2</b>	<b>0</b>	<b>0</b>	<b>0</b>	<b>0</b>	<b>0</b>	<b>1</b>	<b>0</b>	<b>0</b>	<b>0</b>	<b>0</b>	<b>0</b>	<b>3</b>		

Count Summaries - Bikes																		
Interval Start	Percy Ln				n/a				Plaza Cir				Plaza Cir				15-min Total	Rolling Hour Total
	Eastbound				Westbound				Northbound				Southbound					
	UT	LT	TH	RT	UT	LT	TH	RT	UT	LT	TH	RT	UT	LT	TH	RT		
4:00 PM	0	0	0	0	0	0	0	0	0	0	0	0	0	0	0	0	0	0
4:15 PM	0	0	0	0	0	0	0	0	0	0	0	0	0	0	0	0	0	0
<b>4:30 PM</b>	<b>0</b>	<b>0</b>	<b>0</b>	<b>0</b>	<b>0</b>	<b>0</b>	<b>0</b>	<b>0</b>	<b>0</b>	<b>0</b>	<b>0</b>	<b>0</b>	<b>0</b>	<b>0</b>	<b>0</b>	<b>0</b>	<b>0</b>	<b>0</b>
4:45 PM	0	0	0	0	0	0	0	0	0	0	0	0	0	0	0	0	0	0
5:00 PM	0	0	0	0	0	0	0	0	0	0	0	0	0	0	0	0	0	0
5:15 PM	0	0	0	0	0	0	0	0	0	0	0	0	0	0	0	0	0	0
5:30 PM	0	0	0	0	0	0	0	0	0	0	0	0	0	0	0	0	0	0
5:45 PM	0	0	0	0	0	0	0	0	0	0	0	0	0	0	0	0	0	0
Count Total	0	0	0	0	0	0	0	0	0	0	0	0	0	0	0	0	0	
<b>Pk Hr Bike</b>	<b>0</b>	<b>0</b>	<b>0</b>	<b>0</b>	<b>0</b>	<b>0</b>	<b>0</b>	<b>0</b>	<b>0</b>	<b>0</b>	<b>0</b>	<b>0</b>	<b>0</b>	<b>0</b>	<b>0</b>	<b>0</b>		

### Greensborough Dr Plaza Dr



Date: 1/22/2025  
 Count Period: 7:00 AM to 9:00 AM  
 Peak Hour: 7:30 AM to 8:30 AM



	HV%	PHF
EB	1%	0.54
WB	1%	0.65
NB	0%	0.58
SB	0%	0.38
TOTAL	1%	0.59

#### Peak Hour Count Summaries

Peak Hour Interval Start	Plaza Dr				Plaza Dr				Greensborough Dr				Plaza Cir				15-min Total	Rolling Hour Total	
	Eastbound		Westbound		Westbound		Northbound		Southbound		Southbound		Southbound						
	UT	LT	TH	RT	UT	LT	TH	RT	UT	LT	TH	RT	UT	LT	TH	RT			
7:30 AM	0	0	33	2	0	2	85	0	1	0	0	9	0	0	0	0	132	0	
7:45 AM	0	1	154	3	0	8	229	1	0	4	0	14	0	2	0	0	416	0	
8:00 AM	2	4	245	4	0	7	227	1	0	8	0	21	0	1	0	0	520	0	
8:15 AM	0	0	101	1	0	4	52	1	0	1	0	9	0	0	0	0	169	1,237	
Pk Hr	All	2	5	533	10	0	21	593	3	1	13	0	53	0	3	0	0	1,237	
	HV	0	0	3	0	0	0	6	1	0	0	0	0	0	0	0	0	10	
	HV%	0%	0%	1%	0%	-	0%	1%	33%	0%	0%	-	0%	-	0%	-	-	1%	

Note: For complete count summary (all intervals), see following pages.  
 \*\* Heavy Vehicle Classifications include FHWA Classes 4-13.  
 \*\* Count Summaries include heavy vehicles, but exclude bicycles in overall count.

Interval Start	Heavy Vehicle Totals					Bicycles					Pedestrians (Crossing Leg)				
	EB	WB	NB	SB	Total	EB	WB	NB	SB	Total	E	W	N	S	Total
7:30 AM	0	2	0	0	2	0	0	0	0	0	0	0	0	0	0
7:45 AM	1	2	0	0	3	0	0	0	0	0	0	0	0	0	0
8:00 AM	1	1	0	0	2	0	0	0	0	0	0	0	0	0	0
8:15 AM	1	2	0	0	3	0	0	0	0	0	0	0	0	1	1
Peak Hour	3	7	0	0	10	0	0	0	0	0	0	0	0	1	1

Count Summaries - All Vehicles																			
Interval Start	Plaza Dr				Plaza Dr				Greensborough Dr				Plaza Cir				15-min Total	Rolling Hour Total	
	Eastbound				Westbound				Northbound				Southbound						
	UT	LT	TH	RT	UT	LT	TH	RT	UT	LT	TH	RT	UT	LT	TH	RT			
7:00 AM	0	0	36	0	0	6	46	0	0	3	0	16	0	1	0	0	108	0	
7:15 AM	0	0	37	0	0	0	55	0	0	4	0	16	0	0	0	0	112	0	
7:30 AM	0	0	33	2	0	2	85	0	1	0	0	9	0	0	0	0	132	0	
7:45 AM	0	1	154	3	0	8	229	1	0	4	0	14	0	2	0	0	416	768	
8:00 AM	2	4	245	4	0	7	227	1	0	8	0	21	0	1	0	0	520	1,180	
8:15 AM	0	0	101	1	0	4	52	1	0	1	0	9	0	0	0	0	169	1,237	
8:30 AM	0	0	33	0	1	3	46	2	0	2	1	7	0	0	1	0	96	1,201	
8:45 AM	0	1	33	1	0	8	39	2	0	2	0	18	0	0	0	0	104	889	
Count Total	2	6	672	11	1	38	779	7	1	24	1	110	0	4	1	0	1,657		
Pk Hr	All	2	5	533	10	0	21	593	3	1	13	0	53	0	3	0	0	1,237	
	HV	0	0	3	0	0	0	6	1	0	0	0	0	0	0	0	0	10	
	HV%	0%	0%	1%	0%	-	0%	1%	33%	0%	0%	-	0%	-	0%	-	-	1%	

Interval Start	Heavy Vehicle Totals					Bicycles					Pedestrians (Crossing Leg)				
	EB	WB	NB	SB	Total	EB	WB	NB	SB	Total	E	W	N	S	Total
7:00 AM	0	0	0	0	0	0	0	0	0	0	0	0	0	0	0
7:15 AM	0	1	0	0	1	0	0	0	0	0	0	0	0	1	1
7:30 AM	0	2	0	0	2	0	0	0	0	0	0	0	0	0	0
7:45 AM	1	2	0	0	3	0	0	0	0	0	0	0	0	0	0
8:00 AM	1	1	0	0	2	0	0	0	0	0	0	0	0	0	0
8:15 AM	1	2	0	0	3	0	0	0	0	0	0	0	0	1	1
8:30 AM	0	2	0	0	2	0	0	0	0	0	0	0	0	0	0
8:45 AM	1	6	0	0	7	0	0	0	0	0	0	0	0	1	1
Count Total	4	16	0	0	20	0	0	0	0	0	0	0	0	3	3
Peak Hour	3	7	0	0	10	0	0	0	0	0	0	0	0	1	1

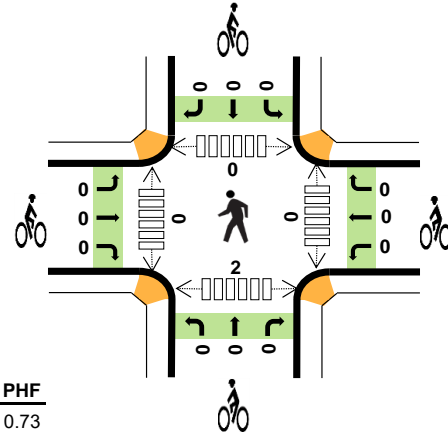
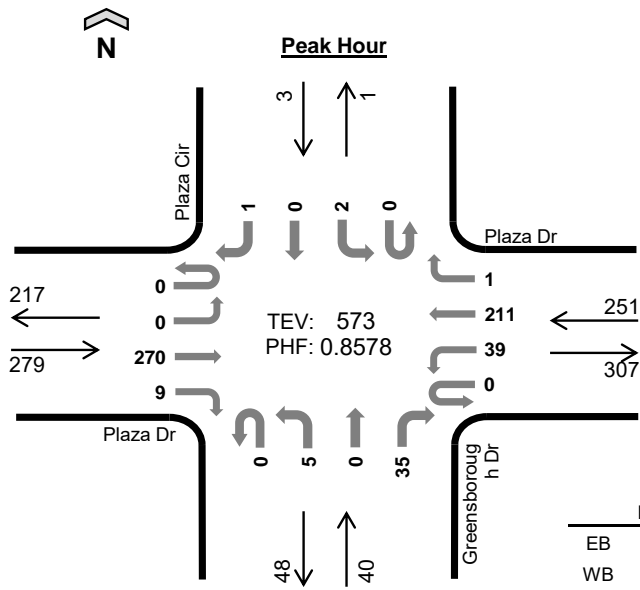
Count Summaries - Heavy Vehicles																		
Interval Start	Plaza Dr				Plaza Dr				Greensborough Dr				Plaza Cir				15-min Total	Rolling Hour Total
	Eastbound				Westbound				Northbound				Southbound					
	UT	LT	TH	RT	UT	LT	TH	RT	UT	LT	TH	RT	UT	LT	TH	RT		
7:00 AM	0	0	0	0	0	0	0	0	0	0	0	0	0	0	0	0	0	0
7:15 AM	0	0	0	0	0	0	1	0	0	0	0	0	0	0	0	0	1	0
7:30 AM	0	0	0	0	0	0	2	0	0	0	0	0	0	0	0	0	2	0
7:45 AM	0	0	1	0	0	0	1	1	0	0	0	0	0	0	0	0	3	6
8:00 AM	0	0	1	0	0	0	1	0	0	0	0	0	0	0	0	0	2	8
8:15 AM	0	0	1	0	0	0	2	0	0	0	0	0	0	0	0	0	3	10
8:30 AM	0	0	0	0	0	0	1	1	0	0	0	0	0	0	0	0	2	10
8:45 AM	0	0	1	0	0	0	5	1	0	0	0	0	0	0	0	0	7	14
Count Total	0	0	4	0	0	0	13	3	0	0	0	0	0	0	0	0	20	
Pk Hr Heavy	0	0	3	0	0	0	6	1	0	0	0	0	0	0	0	0	10	

Count Summaries - Bikes																		
Interval Start	Plaza Dr				Plaza Dr				Greensborough Dr				Plaza Cir				15-min Total	Rolling Hour Total
	Eastbound				Westbound				Northbound				Southbound					
	UT	LT	TH	RT	UT	LT	TH	RT	UT	LT	TH	RT	UT	LT	TH	RT		
7:00 AM	0	0	0	0	0	0	0	0	0	0	0	0	0	0	0	0	0	0
7:15 AM	0	0	0	0	0	0	0	0	0	0	0	0	0	0	0	0	0	0
7:30 AM	0	0	0	0	0	0	0	0	0	0	0	0	0	0	0	0	0	0
7:45 AM	0	0	0	0	0	0	0	0	0	0	0	0	0	0	0	0	0	0
8:00 AM	0	0	0	0	0	0	0	0	0	0	0	0	0	0	0	0	0	0
8:15 AM	0	0	0	0	0	0	0	0	0	0	0	0	0	0	0	0	0	0
8:30 AM	0	0	0	0	0	0	0	0	0	0	0	0	0	0	0	0	0	0
8:45 AM	0	0	0	0	0	0	0	0	0	0	0	0	0	0	0	0	0	0
Count Total	0	0	0	0	0	0	0	0	0	0	0	0	0	0	0	0	0	
Pk Hr Bike	0	0	0	0	0	0	0	0	0	0	0	0	0	0	0	0	0	

### Greensborough Dr Plaza Dr



Date: 1/22/2025  
 Count Period: 4:00 PM to 6:00 PM  
 Peak Hour: 4:00 PM to 5:00 PM



	HV%	PHF
EB	1%	0.73
WB	2%	0.92
NB	0%	0.67
SB	0%	0.38
TOTAL	1%	0.86

#### Peak Hour Count Summaries

Peak Hour Interval Start	Plaza Dr				Plaza Dr				Greensborough Dr				Plaza Cir				15-min Total	Rolling Hour Total	
	Eastbound		Westbound		Westbound		Northbound		Southbound		Southbound		Southbound						
	UT	LT	TH	RT	UT	LT	TH	RT	UT	LT	TH	RT	UT	LT	TH	RT			
4:00 PM	0	0	93	2	0	13	47	1	0	2	0	9	0	0	0	0	167	0	
4:15 PM	0	0	45	3	0	8	60	0	0	1	0	7	0	1	0	0	125	0	
4:30 PM	0	0	76	1	0	11	48	0	0	2	0	13	0	0	0	0	151	0	
4:45 PM	0	0	56	3	0	7	56	0	0	0	0	6	0	1	0	1	130	573	
Pk Hr	All	0	0	270	9	0	39	211	1	0	5	0	35	0	2	0	1	573	
	HV	0	0	3	0	0	0	4	0	0	0	0	0	0	0	0	0	7	
	HV%	-	-	1%	0%	-	0%	2%	0%	-	0%	-	0%	-	0%	-	0%	1%	

Note: For complete count summary (all intervals), see following pages.  
 \*\* Heavy Vehicle Classifications include FHWA Classes 4-13.  
 \*\* Count Summaries include heavy vehicles, but exclude bicycles in overall count.

Interval Start	Heavy Vehicle Totals					Bicycles					Pedestrians (Crossing Leg)				
	EB	WB	NB	SB	Total	EB	WB	NB	SB	Total	E	W	N	S	Total
4:00 PM	1	0	0	0	1	0	0	0	0	0	0	0	0	0	0
4:15 PM	1	1	0	0	2	0	0	0	0	0	0	0	0	0	0
4:30 PM	0	1	0	0	1	0	0	0	0	0	0	0	0	0	0
4:45 PM	1	2	0	0	3	0	0	0	0	0	0	0	0	2	2
Peak Hour	3	4	0	0	7	0	0	0	0	0	0	0	0	2	2

Count Summaries - All Vehicles																			
Interval Start	Plaza Dr				Plaza Dr				Greensborough Dr				Plaza Cir				15-min Total	Rolling Hour Total	
	Eastbound				Westbound				Northbound				Southbound						
	UT	LT	TH	RT	UT	LT	TH	RT	UT	LT	TH	RT	UT	LT	TH	RT			
4:00 PM	0	0	93	2	0	13	47	1	0	2	0	9	0	0	0	0	167	0	
4:15 PM	0	0	45	3	0	8	60	0	0	1	0	7	0	1	0	0	125	0	
4:30 PM	0	0	76	1	0	11	48	0	0	2	0	13	0	0	0	0	151	0	
4:45 PM	0	0	56	3	0	7	56	0	0	0	0	6	0	1	0	1	130	573	
5:00 PM	0	0	57	4	0	11	47	0	1	2	0	3	0	0	0	0	125	531	
5:15 PM	0	0	46	2	0	12	57	1	0	3	0	9	0	0	0	0	130	536	
5:30 PM	0	0	36	2	0	8	54	1	0	1	0	8	0	0	0	0	110	495	
5:45 PM	0	0	35	1	0	7	35	0	0	1	0	8	0	0	0	0	87	452	
Count Total	0	0	444	18	0	77	404	3	1	12	0	63	0	2	0	1	1,025		
Pk Hr	All	0	0	270	9	0	39	211	1	0	5	0	35	0	2	0	1	573	
	HV	0	0	3	0	0	0	4	0	0	0	0	0	0	0	0	0	7	
	HV%	-	-	1%	0%	-	0%	2%	0%	-	0%	-	0%	-	0%	-	0%	1%	

Interval Start	Heavy Vehicle Totals					Bicycles					Pedestrians (Crossing Leg)				
	EB	WB	NB	SB	Total	EB	WB	NB	SB	Total	E	W	N	S	Total
4:00 PM	1	0	0	0	1	0	0	0	0	0	0	0	0	0	0
4:15 PM	1	1	0	0	2	0	0	0	0	0	0	0	0	0	0
4:30 PM	0	1	0	0	1	0	0	0	0	0	0	0	0	0	0
4:45 PM	1	2	0	0	3	0	0	0	0	0	0	0	0	2	2
5:00 PM	0	0	0	0	0	0	0	0	0	0	1	2	0	0	1
5:15 PM	0	0	0	0	0	0	0	0	0	0	0	0	0	1	1
5:30 PM	0	1	0	0	1	0	0	0	0	0	0	0	0	0	0
5:45 PM	1	0	0	0	1	0	0	0	0	0	0	0	0	0	0
Count Total	4	5	0	0	9	0	0	0	0	0	1	0	0	3	4
Peak Hour	3	4	0	0	7	0	0	0	0	0	0	0	0	2	2

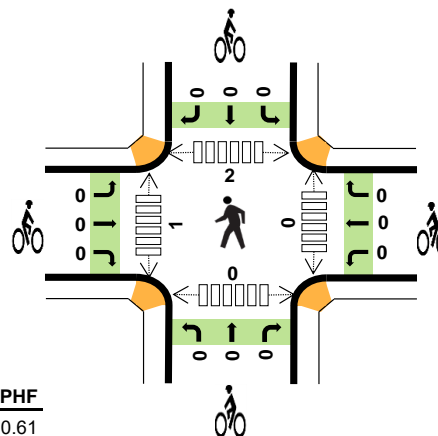
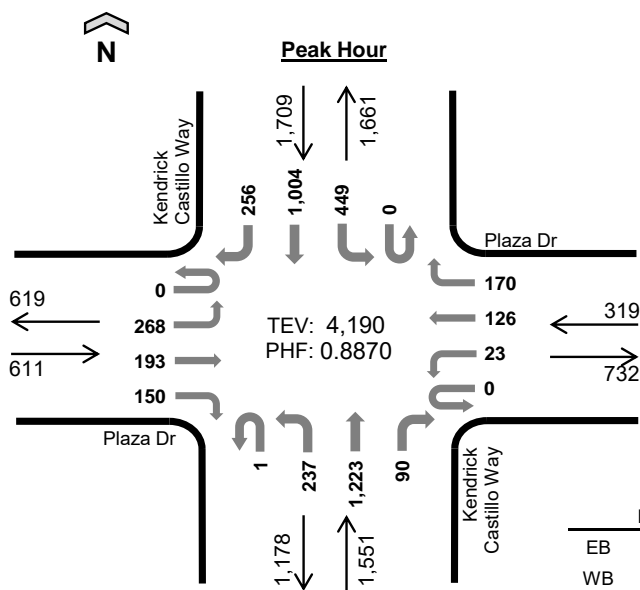
<b>Count Summaries - Heavy Vehicles</b>																		
Interval Start	Plaza Dr				Plaza Dr				Greensborough Dr				Plaza Cir				15-min Total	Rolling Hour Total
	Eastbound				Westbound				Northbound				Southbound					
	UT	LT	TH	RT	UT	LT	TH	RT	UT	LT	TH	RT	UT	LT	TH	RT		
4:00 PM	0	0	1	0	0	0	0	0	0	0	0	0	0	0	0	0	1	0
4:15 PM	0	0	1	0	0	0	1	0	0	0	0	0	0	0	0	0	2	0
4:30 PM	0	0	0	0	0	0	1	0	0	0	0	0	0	0	0	0	1	0
4:45 PM	0	0	1	0	0	0	2	0	0	0	0	0	0	0	0	0	3	7
5:00 PM	0	0	0	0	0	0	0	0	0	0	0	0	0	0	0	0	0	6
5:15 PM	0	0	0	0	0	0	0	0	0	0	0	0	0	0	0	0	0	4
5:30 PM	0	0	0	0	0	1	0	0	0	0	0	0	0	0	0	0	1	4
5:45 PM	0	0	1	0	0	0	0	0	0	0	0	0	0	0	0	0	1	2
Count Total	0	0	4	0	0	1	4	0	0	0	0	0	0	0	0	0	9	
Pk Hr Heavy	0	0	3	0	0	0	4	0	0	0	0	0	0	0	0	0	7	

<b>Count Summaries - Bikes</b>																		
Interval Start	Plaza Dr				Plaza Dr				Greensborough Dr				Plaza Cir				15-min Total	Rolling Hour Total
	Eastbound				Westbound				Northbound				Southbound					
	UT	LT	TH	RT	UT	LT	TH	RT	UT	LT	TH	RT	UT	LT	TH	RT		
4:00 PM	0	0	0	0	0	0	0	0	0	0	0	0	0	0	0	0	0	0
4:15 PM	0	0	0	0	0	0	0	0	0	0	0	0	0	0	0	0	0	0
4:30 PM	0	0	0	0	0	0	0	0	0	0	0	0	0	0	0	0	0	0
4:45 PM	0	0	0	0	0	0	0	0	0	0	0	0	0	0	0	0	0	0
5:00 PM	0	0	0	0	0	0	0	0	0	0	0	0	0	0	0	0	0	0
5:15 PM	0	0	0	0	0	0	0	0	0	0	0	0	0	0	0	0	0	0
5:30 PM	0	0	0	0	0	0	0	0	0	0	0	0	0	0	0	0	0	0
5:45 PM	0	0	0	0	0	0	0	0	0	0	0	0	0	0	0	0	0	0
Count Total	0	0	0	0	0	0	0	0	0	0	0	0	0	0	0	0	0	
Pk Hr Bike	0	0	0	0	0	0	0	0	0	0	0	0	0	0	0	0	0	

# Kendrick Castillo Way Plaza Dr



Date: 1/29/2025  
 Count Period: 7:00 AM to 9:00 AM  
 Peak Hour: 7:30 AM to 8:30 AM



	HV%	PHF
EB	0%	0.61
WB	2%	0.77
NB	1%	0.87
SB	2%	0.93
TOTAL	1%	0.89

### Peak Hour Count Summaries

Peak Hour Interval Start	Plaza Dr				Plaza Dr				Kendrick Castillo Way				Kendrick Castillo Way				15-min Total	Rolling Hour Total	
	Eastbound		Westbound		Northbound		Southbound		Northbound		Southbound								
	UT	LT	TH	RT	UT	LT	TH	RT	UT	LT	TH	RT	UT	LT	TH	RT			
7:30 AM	0	38	21	7	0	3	13	49	1	25	395	26	0	133	242	40	993	0	
7:45 AM	0	81	44	43	0	3	44	41	0	101	268	21	0	109	254	68	1,077	0	
8:00 AM	0	98	82	71	0	9	53	41	0	85	265	20	0	121	227	109	1,181	0	
8:15 AM	0	51	46	29	0	8	16	39	0	26	295	23	0	86	281	39	939	4,190	
Pk Hr	All	0	268	193	150	0	23	126	170	1	237	1,223	90	0	449	1,004	256	4,190	
	HV	0	2	0	1	0	0	3	2	0	0	13	0	0	1	20	5	47	
	HV%	-	1%	0%	1%	-	0%	2%	1%	0%	0%	1%	0%	-	0%	2%	2%	1%	

Note: For complete count summary (all intervals), see following pages.  
 \*\* Heavy Vehicle Classifications include FHWA Classes 4-13.  
 \*\* Count Summaries include heavy vehicles, but exclude bicycles in overall count.

Interval Start	Heavy Vehicle Totals					Bicycles					Pedestrians (Crossing Leg)				
	EB	WB	NB	SB	Total	EB	WB	NB	SB	Total	E	W	N	S	Total
7:30 AM	1	0	4	5	10	0	0	0	0	0	0	1	2	0	3
7:45 AM	1	2	2	6	11	0	0	0	0	0	0	0	0	0	0
8:00 AM	1	2	3	4	10	0	0	0	0	0	0	0	0	0	0
8:15 AM	0	1	4	11	16	0	0	0	0	0	0	0	0	0	0
Peak Hour	3	5	13	26	47	0	0	0	0	0	0	1	2	0	3

Count Summaries - All Vehicles																			
Interval Start	Plaza Dr				Plaza Dr				Kendrick Castillo Way				Kendrick Castillo Way				15-min Total	Rolling Hour Total	
	Eastbound				Westbound				Northbound				Southbound						
	UT	LT	TH	RT	UT	LT	TH	RT	UT	LT	TH	RT	UT	LT	TH	RT			
7:00 AM	0	40	8	12	0	3	10	24	0	16	324	11	0	73	184	24	729	0	
7:15 AM	0	65	21	18	0	3	8	45	0	21	335	20	0	125	214	37	912	0	
7:30 AM	0	38	21	7	0	3	13	49	1	25	395	26	0	133	242	40	993	0	
7:45 AM	0	81	44	43	0	3	44	41	0	101	268	21	0	109	254	68	1,077	3,711	
8:00 AM	0	98	82	71	0	9	53	41	0	85	265	20	0	121	227	109	1,181	4,163	
8:15 AM	0	51	46	29	0	8	16	39	0	26	295	23	0	86	281	39	939	4,190	
8:30 AM	0	38	26	14	0	10	14	27	0	31	334	17	0	78	238	45	872	4,069	
8:45 AM	0	32	28	22	0	10	10	24	0	15	305	30	0	103	244	31	854	3,846	
Count Total	0	443	276	216	0	49	168	290	1	320	2,521	168	0	828	1,884	393	7,557		
Pk Hr	All	0	268	193	150	0	23	126	170	1	237	1,223	90	0	449	1,004	256	4,190	
	HV	0	2	0	1	0	0	3	2	0	0	13	0	0	1	20	5	47	
	HV%	-	1%	0%	1%	-	0%	2%	1%	0%	0%	1%	0%	-	0%	2%	2%	1%	

Interval Start	Heavy Vehicle Totals					Bicycles					Pedestrians (Crossing Leg)				
	EB	WB	NB	SB	Total	EB	WB	NB	SB	Total	E	W	N	S	Total
7:00 AM	0	0	3	3	6	0	0	0	0	0	0	0	0	0	0
7:15 AM	0	1	6	5	12	0	0	0	0	0	0	2	1	0	3
7:30 AM	1	0	4	5	10	0	0	0	0	0	0	1	2	0	3
7:45 AM	1	2	2	6	11	0	0	0	0	0	0	0	0	0	0
8:00 AM	1	2	3	4	10	0	0	0	0	0	0	0	0	0	0
8:15 AM	0	1	4	11	16	0	0	0	0	0	0	0	0	0	0
8:30 AM	1	0	4	11	16	0	0	0	0	0	0	0	0	0	0
8:45 AM	1	0	8	11	20	0	0	0	0	0	1	0	0	0	1
Count Total	5	6	34	56	101	0	0	0	0	0	1	3	3	0	7
Peak Hour	3	5	13	26	47	0	0	0	0	0	0	1	2	0	3

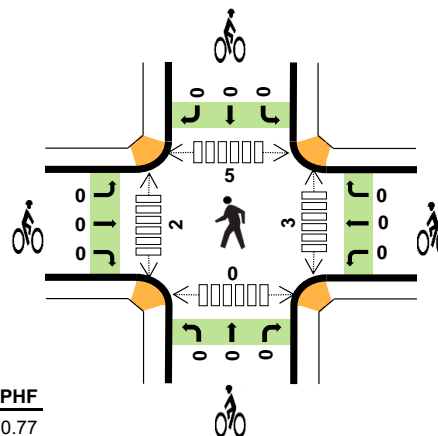
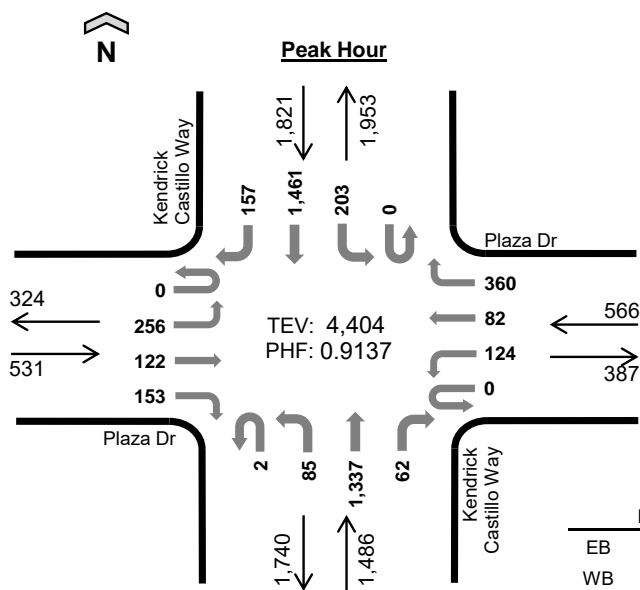
<b>Count Summaries - Heavy Vehicles</b>																		
Interval Start	Plaza Dr				Plaza Dr				Kendrick Castillo Way				Kendrick Castillo Way				15-min Total	Rolling Hour Total
	Eastbound				Westbound				Northbound				Southbound					
	UT	LT	TH	RT	UT	LT	TH	RT	UT	LT	TH	RT	UT	LT	TH	RT		
7:00 AM	0	0	0	0	0	0	0	0	0	0	3	0	0	1	1	1	6	0
7:15 AM	0	0	0	0	0	0	0	1	0	1	4	1	0	1	3	1	12	0
7:30 AM	0	1	0	0	0	0	0	0	0	0	4	0	0	0	5	0	10	0
7:45 AM	0	1	0	0	0	0	1	1	0	0	2	0	0	1	4	1	11	39
8:00 AM	0	0	0	1	0	0	1	1	0	0	3	0	0	0	3	1	10	43
8:15 AM	0	0	0	0	0	0	1	0	0	0	4	0	0	0	8	3	16	47
8:30 AM	0	1	0	0	0	0	0	0	0	0	4	0	0	0	8	3	16	53
8:45 AM	0	0	0	1	0	0	0	0	0	0	7	1	0	0	7	4	20	62
Count Total	0	3	0	2	0	0	3	3	0	1	31	2	0	3	39	14	101	
Pk Hr Heavy	0	2	0	1	0	0	3	2	0	0	13	0	0	1	20	5	47	

<b>Count Summaries - Bikes</b>																		
Interval Start	Plaza Dr				Plaza Dr				Kendrick Castillo Way				Kendrick Castillo Way				15-min Total	Rolling Hour Total
	Eastbound				Westbound				Northbound				Southbound					
	UT	LT	TH	RT	UT	LT	TH	RT	UT	LT	TH	RT	UT	LT	TH	RT		
7:00 AM	0	0	0	0	0	0	0	0	0	0	0	0	0	0	0	0	0	0
7:15 AM	0	0	0	0	0	0	0	0	0	0	0	0	0	0	0	0	0	0
7:30 AM	0	0	0	0	0	0	0	0	0	0	0	0	0	0	0	0	0	0
7:45 AM	0	0	0	0	0	0	0	0	0	0	0	0	0	0	0	0	0	0
8:00 AM	0	0	0	0	0	0	0	0	0	0	0	0	0	0	0	0	0	0
8:15 AM	0	0	0	0	0	0	0	0	0	0	0	0	0	0	0	0	0	0
8:30 AM	0	0	0	0	0	0	0	0	0	0	0	0	0	0	0	0	0	0
8:45 AM	0	0	0	0	0	0	0	0	0	0	0	0	0	0	0	0	0	0
Count Total	0	0	0	0	0	0	0	0	0	0	0	0	0	0	0	0	0	
Pk Hr Bike	0	0	0	0	0	0	0	0	0	0	0	0	0	0	0	0	0	

# Kendrick Castillo Way Plaza Dr



Date: 1/29/2025  
 Count Period: 4:00 PM to 6:00 PM  
 Peak Hour: 4:00 PM to 5:00 PM



	HV%	PHF
EB	1%	0.77
WB	1%	0.88
NB	1%	0.88
SB	0%	0.91
TOTAL	1%	0.91

## Peak Hour Count Summaries

Peak Hour Interval Start	Plaza Dr				Plaza Dr				Kendrick Castillo Way				Kendrick Castillo Way				15-min Total	Rolling Hour Total	
	Eastbound				Westbound				Northbound				Southbound						
	UT	LT	TH	RT	UT	LT	TH	RT	UT	LT	TH	RT	UT	LT	TH	RT			
4:00 PM	0	71	47	54	0	32	23	105	0	23	383	14	0	56	363	34	1,205	0	
4:15 PM	0	66	27	30	0	32	24	102	0	18	359	13	0	38	332	40	1,081	0	
4:30 PM	0	60	25	38	0	28	18	82	1	30	312	15	0	58	391	49	1,107	0	
4:45 PM	0	59	23	31	0	32	17	71	1	14	283	20	0	51	375	34	1,011	4,404	
Pk Hr	All	0	256	122	153	0	124	82	360	2	85	1,337	62	0	203	1,461	157	4,404	
	HV	0	3	1	0	0	0	0	3	0	2	15	2	0	1	6	1	34	
	HV%	-	1%	1%	0%	-	0%	0%	1%	0%	2%	1%	3%	-	0%	0%	1%	1%	

Note: For complete count summary (all intervals), see following pages.  
 \*\* Heavy Vehicle Classifications include FHWA Classes 4-13.  
 \*\* Count Summaries include heavy vehicles, but exclude bicycles in overall count.

Interval Start	Heavy Vehicle Totals					Bicycles					Pedestrians (Crossing Leg)				
	EB	WB	NB	SB	Total	EB	WB	NB	SB	Total	E	W	N	S	Total
4:00 PM	1	2	7	1	11	0	0	0	0	0	2	1	3	0	6
4:15 PM	2	1	4	3	10	0	0	0	0	0	0	1	1	0	2
4:30 PM	0	0	5	2	7	0	0	0	0	0	0	0	0	0	0
4:45 PM	1	0	3	2	6	0	0	0	0	0	1	0	1	0	2
Peak Hour	4	3	19	8	34	0	0	0	0	0	3	2	5	0	10

<b>Count Summaries - All Vehicles</b>																			
Interval Start	Plaza Dr				Plaza Dr				Kendrick Castillo Way				Kendrick Castillo Way				15-min Total	Rolling Hour Total	
	Eastbound				Westbound				Northbound				Southbound						
	UT	LT	TH	RT	UT	LT	TH	RT	UT	LT	TH	RT	UT	LT	TH	RT			
4:00 PM	0	71	47	54	0	32	23	105	0	23	383	14	0	56	363	34	1,205	0	
4:15 PM	0	66	27	30	0	32	24	102	0	18	359	13	0	38	332	40	1,081	0	
4:30 PM	0	60	25	38	0	28	18	82	1	30	312	15	0	58	391	49	1,107	0	
4:45 PM	0	59	23	31	0	32	17	71	1	14	283	20	0	51	375	34	1,011	4,404	
5:00 PM	1	60	32	23	0	21	18	102	1	22	289	13	0	58	399	49	1,088	4,287	
5:15 PM	0	47	17	26	0	37	35	65	1	17	231	22	0	46	373	45	962	4,168	
5:30 PM	0	40	22	25	0	39	17	69	2	27	174	19	0	43	376	38	891	3,952	
5:45 PM	0	39	15	11	0	25	10	70	0	18	189	16	0	41	295	29	758	3,699	
Count Total	1	442	208	238	0	246	162	666	6	169	2,220	132	0	391	2,904	318	8,103		
Pk Hr	All	0	256	122	153	0	124	82	360	2	85	1,337	62	0	203	1,461	157	4,404	
	HV	0	3	1	0	0	0	0	3	0	2	15	2	0	1	6	1	34	
	HV%	-	1%	1%	0%	-	0%	0%	1%	0%	2%	1%	3%	-	0%	0%	1%	1%	

Interval Start	Heavy Vehicle Totals					Bicycles					Pedestrians (Crossing Leg)				
	EB	WB	NB	SB	Total	EB	WB	NB	SB	Total	E	W	N	S	Total
4:00 PM	1	2	7	1	11	0	0	0	0	0	2	1	3	0	6
4:15 PM	2	1	4	3	10	0	0	0	0	0	0	1	1	0	2
4:30 PM	0	0	5	2	7	0	0	0	0	0	0	0	0	0	0
4:45 PM	1	0	3	2	6	0	0	0	0	0	1	0	1	0	2
5:00 PM	1	1	4	2	8	0	0	0	0	0	0	0	1	0	1
5:15 PM	3	0	1	4	8	0	0	0	0	0	0	1	0	0	1
5:30 PM	1	1	2	3	7	0	0	0	0	0	1	1	0	0	2
5:45 PM	0	0	0	1	1	0	0	0	0	0	0	0	0	0	0
Count Total	9	5	26	18	58	0	0	0	0	0	4	4	6	0	14
Peak Hour	4	3	19	8	34	0	0	0	0	0	3	2	5	0	10

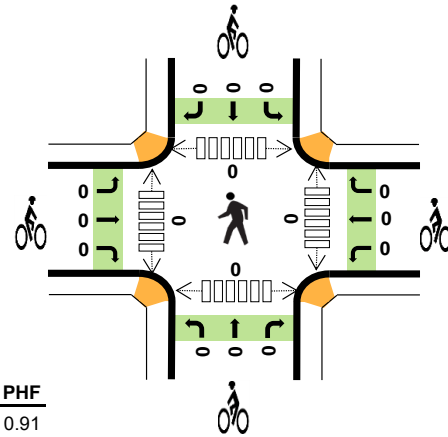
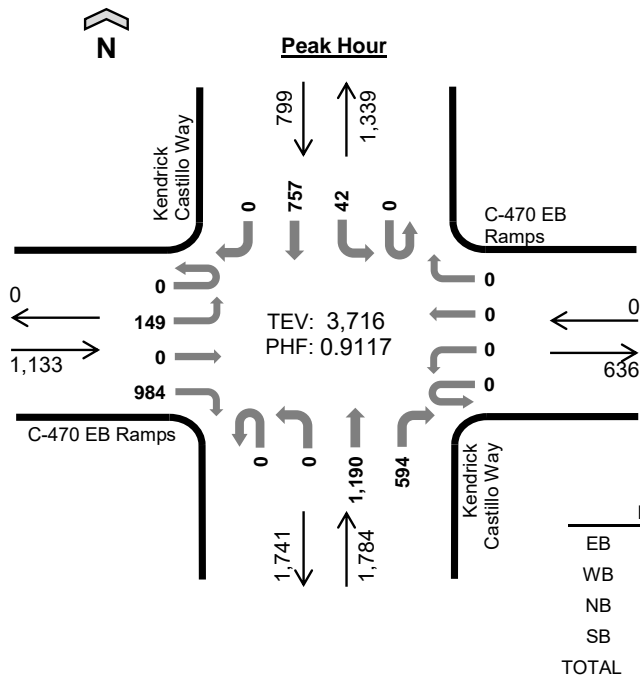
<b>Count Summaries - Heavy Vehicles</b>																		
Interval Start	Plaza Dr				Plaza Dr				Kendrick Castillo Way				Kendrick Castillo Way				15-min Total	Rolling Hour Total
	Eastbound				Westbound				Northbound				Southbound					
	UT	LT	TH	RT	UT	LT	TH	RT	UT	LT	TH	RT	UT	LT	TH	RT		
4:00 PM	0	1	0	0	0	0	0	2	0	1	4	2	0	1	0	0	11	0
4:15 PM	0	1	1	0	0	0	0	1	0	1	3	0	0	0	2	1	10	0
4:30 PM	0	0	0	0	0	0	0	0	0	0	5	0	0	0	2	0	7	0
4:45 PM	0	1	0	0	0	0	0	0	0	0	3	0	0	0	2	0	6	34
5:00 PM	0	0	1	0	0	0	1	0	0	0	4	0	0	0	2	0	8	31
5:15 PM	0	2	1	0	0	0	0	0	0	0	1	0	0	0	4	0	8	29
5:30 PM	0	0	1	0	0	1	0	0	0	0	2	0	0	0	3	0	7	29
5:45 PM	0	0	0	0	0	0	0	0	0	0	0	0	0	0	1	0	1	24
Count Total	0	5	4	0	0	1	1	3	0	2	22	2	0	1	16	1	58	
Pk Hr Heavy	0	3	1	0	0	0	0	3	0	2	15	2	0	1	6	1	34	

<b>Count Summaries - Bikes</b>																		
Interval Start	Plaza Dr				Plaza Dr				Kendrick Castillo Way				Kendrick Castillo Way				15-min Total	Rolling Hour Total
	Eastbound				Westbound				Northbound				Southbound					
	UT	LT	TH	RT	UT	LT	TH	RT	UT	LT	TH	RT	UT	LT	TH	RT		
4:00 PM	0	0	0	0	0	0	0	0	0	0	0	0	0	0	0	0	0	0
4:15 PM	0	0	0	0	0	0	0	0	0	0	0	0	0	0	0	0	0	0
4:30 PM	0	0	0	0	0	0	0	0	0	0	0	0	0	0	0	0	0	0
4:45 PM	0	0	0	0	0	0	0	0	0	0	0	0	0	0	0	0	0	0
5:00 PM	0	0	0	0	0	0	0	0	0	0	0	0	0	0	0	0	0	0
5:15 PM	0	0	0	0	0	0	0	0	0	0	0	0	0	0	0	0	0	0
5:30 PM	0	0	0	0	0	0	0	0	0	0	0	0	0	0	0	0	0	0
5:45 PM	0	0	0	0	0	0	0	0	0	0	0	0	0	0	0	0	0	0
Count Total	0	0	0	0	0	0	0	0	0	0	0	0	0	0	0	0	0	
Pk Hr Bike	0	0	0	0	0	0	0	0	0	0	0	0	0	0	0	0	0	

## Kendrick Castillo Way C-470 EB Ramps



Date: 1/22/2025  
 Count Period: 7:00 AM to 9:00 AM  
 Peak Hour: 7:15 AM to 8:15 AM



	HV%	PHF
EB	1%	0.91
WB	--	--
NB	1%	0.92
SB	2%	0.87
TOTAL	1%	0.91

### Peak Hour Count Summaries

Peak Hour Interval Start	C-470 EB Ramps				C-470 EB Ramps				Kendrick Castillo Way				Kendrick Castillo Way				15-min Total	Rolling Hour Total	
	Eastbound				Westbound				Northbound				Southbound						
	UT	LT	TH	RT	UT	LT	TH	RT	UT	LT	TH	RT	UT	LT	TH	RT			
7:15 AM	0	36	0	209	0	0	0	0	0	0	286	160	0	7	145	0	843	0	
7:30 AM	0	37	0	236	0	0	0	0	0	0	303	150	0	20	182	0	928	0	
7:45 AM	0	44	0	261	0	0	0	0	0	0	335	150	0	9	220	0	1,019	0	
8:00 AM	0	32	0	278	0	0	0	0	0	0	266	134	0	6	210	0	926	3,716	
Pk Hr	All	0	149	0	984	0	0	0	0	0	0	1,190	594	0	42	757	0	3,716	
	HV	0	2	0	10	0	0	0	0	0	0	7	3	0	7	12	0	41	
	HV%	-	1%	-	1%	-	-	-	-	-	-	1%	1%	-	17%	2%	-	1%	

Note: For complete count summary (all intervals), see following pages.  
 \*\* Heavy Vehicle Classifications include FHWA Classes 4-13.  
 \*\* Count Summaries include heavy vehicles, but exclude bicycles in overall count.

Interval Start	Heavy Vehicle Totals					Bicycles					Pedestrians (Crossing Leg)				
	EB	WB	NB	SB	Total	EB	WB	NB	SB	Total	E	W	N	S	Total
7:15 AM	4	0	1	3	8	0	0	0	0	0	0	0	0	0	0
7:30 AM	1	0	0	7	8	0	0	0	0	0	0	0	0	0	0
7:45 AM	4	0	6	5	15	0	0	0	0	0	0	0	0	0	0
8:00 AM	3	0	3	4	10	0	0	0	0	0	0	0	0	0	0
Peak Hour	12	0	10	19	41	0	0	0	0	0	0	0	0	0	0

Count Summaries - All Vehicles																		
Interval Start	C-470 EB Ramps				C-470 EB Ramps				Kendrick Castillo Way				Kendrick Castillo Way				15-min Total	Rolling Hour Total
	Eastbound				Westbound				Northbound				Southbound					
	UT	LT	TH	RT	UT	LT	TH	RT	UT	LT	TH	RT	UT	LT	TH	RT		
7:00 AM	0	19	0	155	0	0	0	0	0	0	239	151	0	12	149	0	725	0
7:15 AM	0	36	0	209	0	0	0	0	0	0	286	160	0	7	145	0	843	0
7:30 AM	0	37	0	236	0	0	0	0	0	0	303	150	0	20	182	0	928	0
7:45 AM	0	44	0	261	0	0	0	0	0	0	335	150	0	9	220	0	1,019	3,515
8:00 AM	0	32	0	278	0	0	0	0	0	0	266	134	0	6	210	0	926	3,716
8:15 AM	0	30	0	202	0	0	0	0	0	0	219	143	0	13	174	0	781	3,654
8:30 AM	0	21	0	187	0	0	0	0	0	0	211	151	0	16	176	0	762	3,488
8:45 AM	0	28	0	218	0	0	0	0	0	0	214	143	0	16	159	0	778	3,247
Count Total	0	247	0	1,746	0	0	0	0	0	0	2,073	1,182	0	99	1,415	0	6,762	
Pk Hr	All	0	149	0	984	0	0	0	0	0	1,190	594	0	42	757	0	3,716	
	HV	0	2	0	10	0	0	0	0	0	7	3	0	7	12	0	41	
	HV%	-	1%	-	1%	-	-	-	-	-	1%	1%	-	17%	2%	-	1%	

Interval Start	Heavy Vehicle Totals					Bicycles					Pedestrians (Crossing Leg)				
	EB	WB	NB	SB	Total	EB	WB	NB	SB	Total	E	W	N	S	Total
7:00 AM	1	0	0	3	4	0	0	0	0	0	0	0	0	0	0
7:15 AM	4	0	1	3	8	0	0	0	0	0	0	0	0	0	0
7:30 AM	1	0	0	7	8	0	0	0	0	0	0	0	0	0	0
7:45 AM	4	0	6	5	15	0	0	0	0	0	0	0	0	0	0
8:00 AM	3	0	3	4	10	0	0	0	0	0	0	0	0	0	0
8:15 AM	4	0	5	4	13	0	0	0	0	0	0	0	0	0	0
8:30 AM	5	0	7	3	15	0	0	0	0	0	0	0	0	0	0
8:45 AM	6	0	8	9	23	0	0	0	0	0	0	0	0	0	0
Count Total	28	0	30	38	96	0	0	0	0	0	0	0	0	0	0
Peak Hour	12	0	10	19	41	0	0	0	0	0	0	0	0	0	0

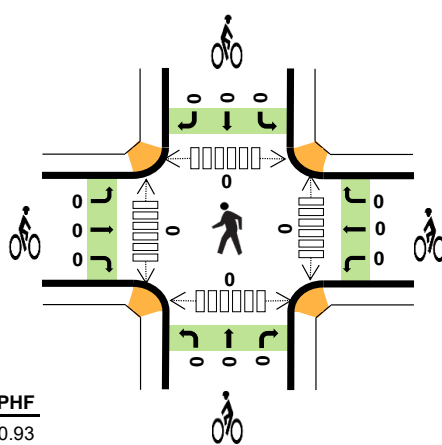
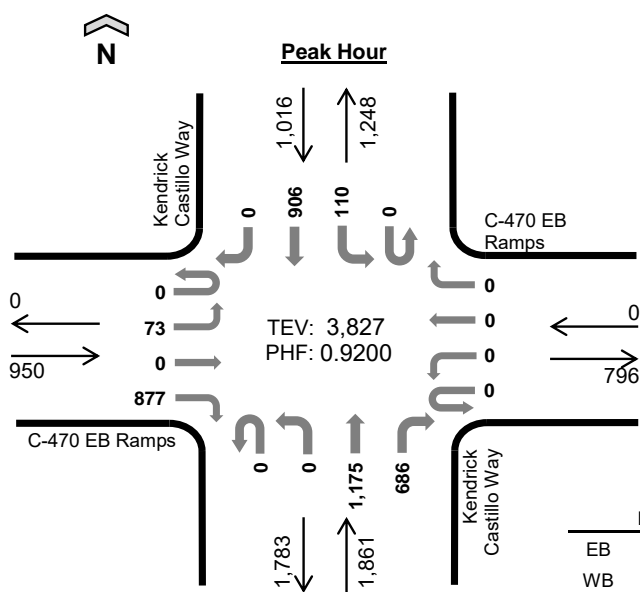
<b>Count Summaries - Heavy Vehicles</b>																		
Interval Start	C-470 EB Ramps				C-470 EB Ramps				Kendrick Castillo Way				Kendrick Castillo Way				15-min Total	Rolling Hour Total
	Eastbound				Westbound				Northbound				Southbound					
	UT	LT	TH	RT	UT	LT	TH	RT	UT	LT	TH	RT	UT	LT	TH	RT		
7:00 AM	0	0	0	1	0	0	0	0	0	0	0	0	0	0	3	0	4	0
7:15 AM	0	1	0	3	0	0	0	0	0	0	1	0	0	1	2	0	8	0
7:30 AM	0	0	0	1	0	0	0	0	0	0	0	0	0	4	3	0	8	0
7:45 AM	0	0	0	4	0	0	0	0	0	0	4	2	0	1	4	0	15	35
8:00 AM	0	1	0	2	0	0	0	0	0	0	2	1	0	1	3	0	10	41
8:15 AM	0	0	0	4	0	0	0	0	0	0	3	2	0	1	3	0	13	46
8:30 AM	0	0	0	5	0	0	0	0	0	0	3	4	0	0	3	0	15	53
8:45 AM	0	0	0	6	0	0	0	0	0	0	5	3	0	0	9	0	23	61
Count Total	0	2	0	26	0	0	0	0	0	0	18	12	0	8	30	0	96	
Pk Hr Heavy	0	2	0	10	0	0	0	0	0	0	7	3	0	7	12	0	41	

<b>Count Summaries - Bikes</b>																		
Interval Start	C-470 EB Ramps				C-470 EB Ramps				Kendrick Castillo Way				Kendrick Castillo Way				15-min Total	Rolling Hour Total
	Eastbound				Westbound				Northbound				Southbound					
	UT	LT	TH	RT	UT	LT	TH	RT	UT	LT	TH	RT	UT	LT	TH	RT		
7:00 AM	0	0	0	0	0	0	0	0	0	0	0	0	0	0	0	0	0	0
7:15 AM	0	0	0	0	0	0	0	0	0	0	0	0	0	0	0	0	0	0
7:30 AM	0	0	0	0	0	0	0	0	0	0	0	0	0	0	0	0	0	0
7:45 AM	0	0	0	0	0	0	0	0	0	0	0	0	0	0	0	0	0	0
8:00 AM	0	0	0	0	0	0	0	0	0	0	0	0	0	0	0	0	0	0
8:15 AM	0	0	0	0	0	0	0	0	0	0	0	0	0	0	0	0	0	0
8:30 AM	0	0	0	0	0	0	0	0	0	0	0	0	0	0	0	0	0	0
8:45 AM	0	0	0	0	0	0	0	0	0	0	0	0	0	0	0	0	0	0
Count Total	0	0	0	0	0	0	0	0	0	0	0	0	0	0	0	0	0	
Pk Hr Bike	0	0	0	0	0	0	0	0	0	0	0	0	0	0	0	0	0	

# Kendrick Castillo Way C-470 EB Ramps



Date: 1/22/2025  
 Count Period: 4:00 PM to 6:00 PM  
 Peak Hour: 4:30 PM to 5:30 PM



	HV%	PHF
EB	1%	0.93
WB	--	--
NB	0%	0.88
SB	1%	0.90
TOTAL	1%	0.92

## Peak Hour Count Summaries

Peak Hour Interval Start	C-470 EB Ramps				C-470 EB Ramps				Kendrick Castillo Way				Kendrick Castillo Way				15-min Total	Rolling Hour Total	
	Eastbound				Westbound				Northbound				Southbound						
	UT	LT	TH	RT	UT	LT	TH	RT	UT	LT	TH	RT	UT	LT	TH	RT			
4:30 PM	0	20	0	236	0	0	0	0	0	0	287	172	0	19	198	0	932	0	
4:45 PM	0	13	0	212	0	0	0	0	0	0	256	156	0	25	220	0	882	0	
5:00 PM	0	19	0	210	0	0	0	0	0	0	324	206	0	44	237	0	1,040	0	
5:15 PM	0	21	0	219	0	0	0	0	0	0	308	152	0	22	251	0	973	3,827	
Pk Hr	All	0	73	0	877	0	0	0	0	0	0	1,175	686	0	110	906	0	3,827	
	HV	0	4	0	3	0	0	0	0	0	0	5	3	0	1	9	0	25	
	HV%	-	5%	-	0%	-	-	-	-	-	-	0%	0%	-	1%	1%	-	1%	

Note: For complete count summary (all intervals), see following pages.  
 \*\* Heavy Vehicle Classifications include FHWA Classes 4-13.  
 \*\* Count Summaries include heavy vehicles, but exclude bicycles in overall count.

Interval Start	Heavy Vehicle Totals					Bicycles					Pedestrians (Crossing Leg)				
	EB	WB	NB	SB	Total	EB	WB	NB	SB	Total	E	W	N	S	Total
4:30 PM	2	0	1	2	5	0	0	0	0	0	0	0	0	0	0
4:45 PM	1	0	3	4	8	0	0	0	0	0	0	0	0	0	0
5:00 PM	2	0	2	2	6	0	0	0	0	0	0	0	0	0	0
5:15 PM	2	0	2	2	6	0	0	0	0	0	0	0	0	0	0
Peak Hour	7	0	8	10	25	0	0	0	0	0	0	0	0	0	0

Count Summaries - All Vehicles																		
Interval Start	C-470 EB Ramps				C-470 EB Ramps				Kendrick Castillo Way				Kendrick Castillo Way				15-min Total	Rolling Hour Total
	Eastbound				Westbound				Northbound				Southbound					
	UT	LT	TH	RT	UT	LT	TH	RT	UT	LT	TH	RT	UT	LT	TH	RT		
4:00 PM	0	13	0	178	0	0	0	0	0	0	274	174	0	41	194	0	874	0
4:15 PM	0	21	0	223	0	0	0	0	0	0	282	195	0	27	204	0	952	0
4:30 PM	0	20	0	236	0	0	0	0	0	0	287	172	0	19	198	0	932	0
4:45 PM	0	13	0	212	0	0	0	0	0	0	256	156	0	25	220	0	882	3,640
5:00 PM	0	19	0	210	0	0	0	0	0	0	324	206	0	44	237	0	1,040	3,806
5:15 PM	0	21	0	219	0	0	0	0	0	0	308	152	0	22	251	0	973	3,827
5:30 PM	0	6	0	205	0	0	0	0	0	0	219	144	0	15	249	0	838	3,733
5:45 PM	0	7	0	199	0	0	0	0	0	0	204	135	0	18	224	0	787	3,638
Count Total	0	120	0	1,682	0	0	0	0	0	0	2,154	1,334	0	211	1,777	0	7,278	
Pk Hr	All	0	73	0	877	0	0	0	0	0	1,175	686	0	110	906	0	3,827	
	HV	0	4	0	3	0	0	0	0	0	5	3	0	1	9	0	25	
	HV%	-	5%	-	0%	-	-	-	-	-	0%	0%	-	1%	1%	-	1%	

Interval Start	Heavy Vehicle Totals					Bicycles					Pedestrians (Crossing Leg)				
	EB	WB	NB	SB	Total	EB	WB	NB	SB	Total	E	W	N	S	Total
4:00 PM	2	0	3	4	9	0	0	0	0	0	0	0	0	0	0
4:15 PM	4	0	7	2	13	0	0	0	0	0	0	0	0	0	0
4:30 PM	2	0	1	2	5	0	0	0	0	0	0	0	0	0	0
4:45 PM	1	0	3	4	8	0	0	0	0	0	0	0	0	0	0
5:00 PM	2	0	2	2	6	0	0	0	0	0	0	0	0	0	0
5:15 PM	2	0	2	2	6	0	0	0	0	0	0	0	0	0	0
5:30 PM	0	0	0	0	0	0	0	0	0	0	0	0	0	0	0
5:45 PM	0	0	1	1	2	0	0	0	0	0	0	0	0	0	0
Count Total	13	0	19	17	49	0	0	0	0	0	0	0	0	0	0
Peak Hour	7	0	8	10	25	0	0	0	0	0	0	0	0	0	0

<b>Count Summaries - Heavy Vehicles</b>																		
Interval Start	C-470 EB Ramps				C-470 EB Ramps				Kendrick Castillo Way				Kendrick Castillo Way				15-min Total	Rolling Hour Total
	Eastbound				Westbound				Northbound				Southbound					
	UT	LT	TH	RT	UT	LT	TH	RT	UT	LT	TH	RT	UT	LT	TH	RT		
4:00 PM	0	2	0	0	0	0	0	0	0	0	0	3	0	0	4	0	9	0
4:15 PM	0	4	0	0	0	0	0	0	0	0	4	3	0	1	1	0	13	0
4:30 PM	0	0	0	2	0	0	0	0	0	0	1	0	0	1	1	0	5	0
4:45 PM	0	1	0	0	0	0	0	0	0	0	2	1	0	0	4	0	8	35
5:00 PM	0	2	0	0	0	0	0	0	0	0	1	1	0	0	2	0	6	32
5:15 PM	0	1	0	1	0	0	0	0	0	0	1	1	0	0	2	0	6	25
5:30 PM	0	0	0	0	0	0	0	0	0	0	0	0	0	0	0	0	0	20
5:45 PM	0	0	0	0	0	0	0	0	0	0	1	0	0	0	1	0	2	14
Count Total	0	10	0	3	0	0	0	0	0	0	10	9	0	2	15	0	49	
Pk Hr Heavy	0	4	0	3	0	0	0	0	0	0	5	3	0	1	9	0	25	

<b>Count Summaries - Bikes</b>																		
Interval Start	C-470 EB Ramps				C-470 EB Ramps				Kendrick Castillo Way				Kendrick Castillo Way				15-min Total	Rolling Hour Total
	Eastbound				Westbound				Northbound				Southbound					
	UT	LT	TH	RT	UT	LT	TH	RT	UT	LT	TH	RT	UT	LT	TH	RT		
4:00 PM	0	0	0	0	0	0	0	0	0	0	0	0	0	0	0	0	0	0
4:15 PM	0	0	0	0	0	0	0	0	0	0	0	0	0	0	0	0	0	0
4:30 PM	0	0	0	0	0	0	0	0	0	0	0	0	0	0	0	0	0	0
4:45 PM	0	0	0	0	0	0	0	0	0	0	0	0	0	0	0	0	0	0
5:00 PM	0	0	0	0	0	0	0	0	0	0	0	0	0	0	0	0	0	0
5:15 PM	0	0	0	0	0	0	0	0	0	0	0	0	0	0	0	0	0	0
5:30 PM	0	0	0	0	0	0	0	0	0	0	0	0	0	0	0	0	0	0
5:45 PM	0	0	0	0	0	0	0	0	0	0	0	0	0	0	0	0	0	0
Count Total	0	0	0	0	0	0	0	0	0	0	0	0	0	0	0	0	0	
Pk Hr Bike	0	0	0	0	0	0	0	0	0	0	0	0	0	0	0	0	0	



Count Summaries - All Vehicles																			
Interval Start	C-470 WB Ramps				C-470 WB Ramps				Kendrick Castillo Way				Kendrick Castillo Way				15-min Total	Rolling Hour Total	
	Eastbound				Westbound				Northbound				Southbound						
	UT	LT	TH	RT	UT	LT	TH	RT	UT	LT	TH	RT	UT	LT	TH	RT			
7:00 AM	0	0	0	0	0	106	0	17	0	180	71	0	0	0	37	13	424	0	
7:15 AM	0	0	0	0	0	155	0	25	0	194	97	0	0	0	47	9	527	0	
7:30 AM	0	0	0	0	0	130	0	29	0	221	148	0	0	0	41	7	576	0	
7:45 AM	0	0	0	0	0	182	0	46	0	167	171	0	0	0	50	6	622	2,149	
8:00 AM	0	0	0	0	0	141	2	37	0	186	164	0	0	0	65	13	608	2,333	
8:15 AM	0	0	0	0	0	146	0	38	0	159	152	0	0	0	59	7	561	2,367	
8:30 AM	0	0	0	0	0	127	1	41	0	180	155	0	0	0	58	13	575	2,366	
8:45 AM	0	0	0	0	0	119	0	44	2	127	151	0	1	0	47	27	518	2,262	
Count Total	0	0	0	0	0	1,106	3	277	2	1,414	1,109	0	1	0	404	95	4,411		
Pk Hr	All	0	0	0	0	0	599	2	150	0	733	635	0	0	0	215	33	2,367	
	HV	0	0	0	0	0	15	0	1	0	3	5	0	0	0	4	2	30	
	HV%	-	-	-	-	-	3%	0%	1%	-	0%	1%	-	-	-	2%	6%	1%	

Interval Start	Heavy Vehicle Totals					Bicycles					Pedestrians (Crossing Leg)				
	EB	WB	NB	SB	Total	EB	WB	NB	SB	Total	E	W	N	S	Total
7:00 AM	0	1	0	3	4	0	0	0	0	0	0	0	0	0	0
7:15 AM	0	3	1	1	5	0	0	0	0	0	0	0	0	0	0
7:30 AM	0	3	1	1	5	0	0	0	0	0	0	0	0	0	0
7:45 AM	0	4	2	0	6	0	0	0	0	0	0	0	0	0	0
8:00 AM	0	3	2	3	8	0	0	0	0	0	0	0	0	0	0
8:15 AM	0	6	3	2	11	0	0	0	0	0	0	0	0	0	0
8:30 AM	0	8	2	3	13	0	0	0	0	0	0	0	0	0	0
8:45 AM	0	7	4	1	12	0	0	0	0	0	0	0	0	0	0
Count Total	0	35	15	14	64	0	0	0	0	0	0	0	0	0	0
Peak Hour	0	16	8	6	30	0	0	0	0	0	0	0	0	0	0

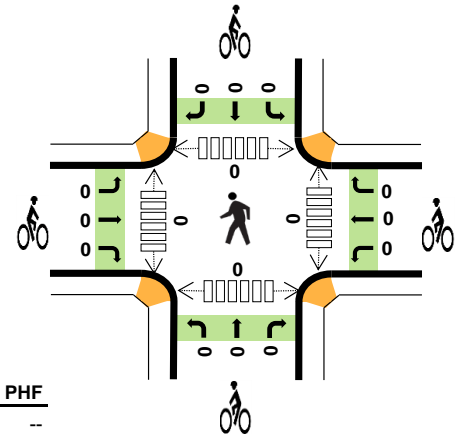
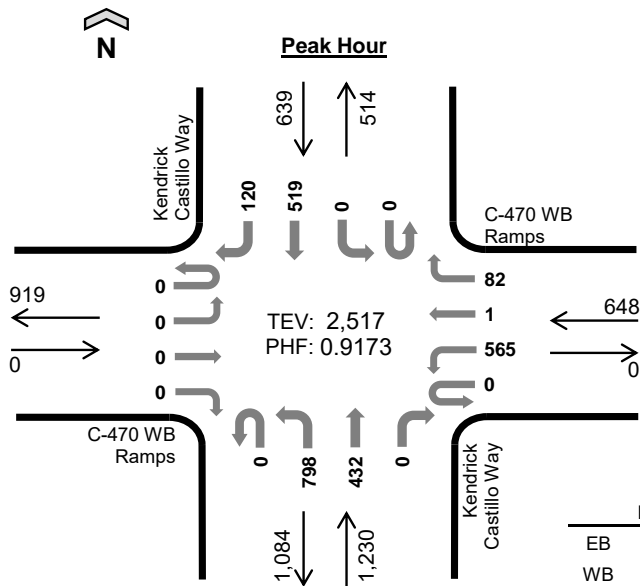
<b>Count Summaries - Heavy Vehicles</b>																				
Interval Start	C-470 WB Ramps				C-470 WB Ramps				Kendrick Castillo Way				Kendrick Castillo Way				15-min Total	Rolling Hour Total		
	Eastbound				Westbound				Northbound				Southbound							
	UT	LT	TH	RT	UT	LT	TH	RT	UT	LT	TH	RT	UT	LT	TH	RT				
7:00 AM	0	0	0	0	0	1	0	0	0	0	0	0	0	0	0	1	2	4	0	
7:15 AM	0	0	0	0	0	1	0	2	0	0	1	0	0	0	0	0	1	0	5	0
7:30 AM	0	0	0	0	0	3	0	0	0	0	1	0	0	0	0	0	1	0	5	0
7:45 AM	0	0	0	0	0	4	0	0	0	0	2	0	0	0	0	0	0	0	6	20
8:00 AM	0	0	0	0	0	2	0	1	0	0	0	2	0	0	0	0	1	2	8	24
8:15 AM	0	0	0	0	0	6	0	0	0	0	0	3	0	0	0	0	2	0	11	30
8:30 AM	0	0	0	0	0	8	0	0	0	0	1	1	0	0	0	0	2	1	13	38
8:45 AM	0	0	0	0	0	7	0	0	0	0	4	0	0	0	0	0	1	0	12	44
Count Total	0	0	0	0	0	32	0	3	0	0	9	6	0	0	0	9	5	64		
Pk Hr Heavy	0	0	0	0	0	15	0	1	0	0	3	5	0	0	0	4	2	30		

<b>Count Summaries - Bikes</b>																				
Interval Start	C-470 WB Ramps				C-470 WB Ramps				Kendrick Castillo Way				Kendrick Castillo Way				15-min Total	Rolling Hour Total		
	Eastbound				Westbound				Northbound				Southbound							
	UT	LT	TH	RT	UT	LT	TH	RT	UT	LT	TH	RT	UT	LT	TH	RT				
7:00 AM	0	0	0	0	0	0	0	0	0	0	0	0	0	0	0	0	0	0	0	0
7:15 AM	0	0	0	0	0	0	0	0	0	0	0	0	0	0	0	0	0	0	0	0
7:30 AM	0	0	0	0	0	0	0	0	0	0	0	0	0	0	0	0	0	0	0	0
7:45 AM	0	0	0	0	0	0	0	0	0	0	0	0	0	0	0	0	0	0	0	0
8:00 AM	0	0	0	0	0	0	0	0	0	0	0	0	0	0	0	0	0	0	0	0
8:15 AM	0	0	0	0	0	0	0	0	0	0	0	0	0	0	0	0	0	0	0	0
8:30 AM	0	0	0	0	0	0	0	0	0	0	0	0	0	0	0	0	0	0	0	0
8:45 AM	0	0	0	0	0	0	0	0	0	0	0	0	0	0	0	0	0	0	0	0
Count Total	0	0	0	0	0	0	0	0	0	0	0	0	0	0	0	0	0	0	0	
Pk Hr Bike	0	0	0	0	0	0	0	0	0	0	0	0	0	0	0	0	0	0	0	

# Kendrick Castillo Way C-470 WB Ramps



Date: 1/29/2025  
 Count Period: 4:00 PM to 6:00 PM  
 Peak Hour: 4:15 PM to 5:15 PM



	HV%	PHF
EB	--	--
WB	2%	0.89
NB	1%	0.89
SB	1%	0.88
TOTAL	1%	0.92

### Peak Hour Count Summaries

Peak Hour Interval Start	C-470 WB Ramps				C-470 WB Ramps				Kendrick Castillo Way				Kendrick Castillo Way				15-min Total	Rolling Hour Total	
	Eastbound		Westbound		Northbound		Southbound		Northbound		Southbound								
	UT	LT	TH	RT	UT	LT	TH	RT	UT	LT	TH	RT	UT	LT	TH	RT			
4:15 PM	0	0	0	0	0	131	0	25	0	187	116	0	0	0	137	20	616	0	
4:30 PM	0	0	0	0	0	130	0	19	0	207	105	0	0	0	124	28	613	0	
4:45 PM	0	0	0	0	0	163	1	19	0	161	109	0	0	0	124	25	602	0	
5:00 PM	0	0	0	0	0	141	0	19	0	243	102	0	0	0	134	47	686	2,517	
Pk Hr	All	0	0	0	0	0	565	1	82	0	798	432	0	0	0	519	120	2,517	
	HV	0	0	0	0	0	9	0	2	0	3	7	0	0	0	2	4	27	
	HV%	-	-	-	-	-	2%	0%	2%	-	0%	2%	-	-	-	0%	3%	1%	

Note: For complete count summary (all intervals), see following pages.  
 \*\* Heavy Vehicle Classifications include FHWA Classes 4-13.  
 \*\* Count Summaries include heavy vehicles, but exclude bicycles in overall count.

Interval Start	Heavy Vehicle Totals					Bicycles					Pedestrians (Crossing Leg)				
	EB	WB	NB	SB	Total	EB	WB	NB	SB	Total	E	W	N	S	Total
4:15 PM	0	2	3	1	6	0	0	0	0	0	0	0	0	0	0
4:30 PM	0	7	4	2	13	0	0	0	0	0	0	0	0	0	0
4:45 PM	0	1	0	2	3	0	0	0	0	0	0	0	0	0	0
5:00 PM	0	1	3	1	5	0	0	0	0	0	0	0	0	0	0
Peak Hour	0	11	10	6	27	0	0	0	0	0	0	0	0	0	0

Count Summaries - All Vehicles																			
Interval Start	C-470 WB Ramps				C-470 WB Ramps				Kendrick Castillo Way				Kendrick Castillo Way				15-min Total	Rolling Hour Total	
	Eastbound				Westbound				Northbound				Southbound						
	UT	LT	TH	RT	UT	LT	TH	RT	UT	LT	TH	RT	UT	LT	TH	RT			
4:00 PM	0	0	0	0	0	132	0	16	0	230	82	0	0	0	126	29	615	0	
4:15 PM	0	0	0	0	0	131	0	25	0	187	116	0	0	0	137	20	616	0	
4:30 PM	0	0	0	0	0	130	0	19	0	207	105	0	0	0	124	28	613	0	
4:45 PM	0	0	0	0	0	163	1	19	0	161	109	0	0	0	124	25	602	2,446	
5:00 PM	0	0	0	0	0	141	0	19	0	243	102	0	0	0	134	47	686	2,517	
5:15 PM	0	0	0	0	0	165	0	22	0	170	92	0	0	0	136	24	609	2,510	
5:30 PM	0	0	0	0	0	113	2	13	0	169	104	0	0	0	107	42	550	2,447	
5:45 PM	0	0	0	0	0	131	0	25	0	110	74	0	0	0	115	16	471	2,316	
Count Total	0	0	0	0	0	1,106	3	158	0	1,477	784	0	0	0	1,003	231	4,762		
Pk Hr	All	0	0	0	0	0	565	1	82	0	798	432	0	0	0	519	120	2,517	
	HV	0	0	0	0	0	9	0	2	0	3	7	0	0	0	2	4	27	
	HV%	-	-	-	-	-	2%	0%	2%	-	0%	2%	-	-	-	0%	3%	1%	

Interval Start	Heavy Vehicle Totals					Bicycles					Pedestrians (Crossing Leg)				
	EB	WB	NB	SB	Total	EB	WB	NB	SB	Total	E	W	N	S	Total
4:00 PM	0	0	2	0	2	0	0	0	0	0	0	0	0	0	0
4:15 PM	0	2	3	1	6	0	0	0	0	0	0	0	0	0	0
4:30 PM	0	7	4	2	13	0	0	0	0	0	0	0	0	0	0
4:45 PM	0	1	0	2	3	0	0	0	0	0	0	0	0	0	0
5:00 PM	0	1	3	1	5	0	0	0	0	0	0	0	0	0	0
5:15 PM	0	5	1	0	6	0	0	0	0	0	0	1	0	0	1
5:30 PM	0	1	2	1	4	0	0	0	0	0	0	0	0	0	0
5:45 PM	0	2	0	1	3	0	0	0	0	0	0	0	0	0	0
Count Total	0	19	15	8	42	0	0	0	0	0	0	1	0	0	1
Peak Hour	0	11	10	6	27	0	0	0	0	0	0	0	0	0	0

<b>Count Summaries - Heavy Vehicles</b>																		
Interval Start	C-470 WB Ramps				C-470 WB Ramps				Kendrick Castillo Way				Kendrick Castillo Way				15-min Total	Rolling Hour Total
	Eastbound				Westbound				Northbound				Southbound					
	UT	LT	TH	RT	UT	LT	TH	RT	UT	LT	TH	RT	UT	LT	TH	RT		
4:00 PM	0	0	0	0	0	0	0	0	0	2	0	0	0	0	0	0	2	0
4:15 PM	0	0	0	0	0	2	0	0	0	0	3	0	0	0	0	1	6	0
4:30 PM	0	0	0	0	0	5	0	2	0	2	2	0	0	0	0	2	13	0
4:45 PM	0	0	0	0	0	1	0	0	0	0	0	0	0	0	2	0	3	24
5:00 PM	0	0	0	0	0	1	0	0	0	1	2	0	0	0	0	1	5	27
5:15 PM	0	0	0	0	0	4	0	1	0	1	0	0	0	0	0	0	6	27
5:30 PM	0	0	0	0	0	1	0	0	0	1	1	0	0	0	1	0	4	18
5:45 PM	0	0	0	0	0	2	0	0	0	0	0	0	0	0	1	0	3	18
Count Total	0	0	0	0	0	16	0	3	0	7	8	0	0	0	4	4	42	
Pk Hr Heavy	0	0	0	0	0	9	0	2	0	3	7	0	0	0	2	4	27	

<b>Count Summaries - Bikes</b>																		
Interval Start	C-470 WB Ramps				C-470 WB Ramps				Kendrick Castillo Way				Kendrick Castillo Way				15-min Total	Rolling Hour Total
	Eastbound				Westbound				Northbound				Southbound					
	UT	LT	TH	RT	UT	LT	TH	RT	UT	LT	TH	RT	UT	LT	TH	RT		
4:00 PM	0	0	0	0	0	0	0	0	0	0	0	0	0	0	0	0	0	0
4:15 PM	0	0	0	0	0	0	0	0	0	0	0	0	0	0	0	0	0	0
4:30 PM	0	0	0	0	0	0	0	0	0	0	0	0	0	0	0	0	0	0
4:45 PM	0	0	0	0	0	0	0	0	0	0	0	0	0	0	0	0	0	0
5:00 PM	0	0	0	0	0	0	0	0	0	0	0	0	0	0	0	0	0	0
5:15 PM	0	0	0	0	0	0	0	0	0	0	0	0	0	0	0	0	0	0
5:30 PM	0	0	0	0	0	0	0	0	0	0	0	0	0	0	0	0	0	0
5:45 PM	0	0	0	0	0	0	0	0	0	0	0	0	0	0	0	0	0	0
Count Total	0	0	0	0	0	0	0	0	0	0	0	0	0	0	0	0	0	
Pk Hr Bike	0	0	0	0	0	0	0	0	0	0	0	0	0	0	0	0	0	

# Appendix C: Future Traffic Projections

**DRCOG Traffic Projections:**

Lucent Station

<b>Location</b>	<b>2020</b>	<b>2050</b>	<b>Growth Factor</b>	<b>Annual Growth</b>
County Line E/O Erickson Dr	11,000	12,000	1.09	0.29%
Kendrick Castillo Way N/O Plaza Dr	41,000	43,000	1.05	0.16%
<b>Total</b>	<b>52,000</b>	<b>55,000</b>	<b>1.06</b>	<b>0.19%</b>

# Appendix D: Trip Generation Worksheets

## Lucent Station Daily Trip Generation Calculations

TRIP GENERATION CHARACTERISTICS					DIRECTIONAL DISTRIBUTION		NEW EXTERNAL VEHICLE TRIPS			
Land Use + Code	Source	Scale	ITE Unit	Equation/Rate	Entering %	Exiting %	In	Out	Total	
1	(215) Single-Family Attached Housing	ITE 12th Ed	84	DU	$T = 6.57(X)$	50%	50%	276	276	552
2	(220) Multifamily Housing (Low-Rise)	ITE 12th Ed	266	DU	$T = 5.63(X) + 120.45$	50%	50%	809	809	1,618
<b>Total:</b>								1,085	1,085	2,170

## Lucent Station AM Peak Hour Trip Generation Calculations

TRIP GENERATION CHARACTERISTICS					DIRECTIONAL DISTRIBUTION		NEW EXTERNAL VEHICLE TRIPS			
Land Use + Code	Source	Scale	ITE Unit	Equation/Rate	Entering %	Exiting %	In	Out	Total	
1	(215) Single-Family Attached Housing	ITE 12th Ed	84	DU	$T = 0.59(X) - 15.25$	25%	75%	9	25	34
2	(220) Multifamily Housing (Low-Rise)	ITE 12th Ed	266	DU	$T = 0.35(X) + 12.93$	24%	76%	25	81	106
<b>Total:</b>								34	106	140

## Lucent Station PM Peak Hour Trip Generation Calculations

TRIP GENERATION CHARACTERISTICS					DIRECTIONAL DISTRIBUTION		NEW EXTERNAL VEHICLE TRIPS			
Land Use + Code	Source	Scale	ITE Unit	Equation/Rate	Entering %	Exiting %	In	Out	Total	
1	(215) Single-Family Attached Housing	ITE 12th Ed	84	DU	$T = 0.57(X) - 7.84$	57%	43%	23	17	40
2	(220) Multifamily Housing (Low-Rise)	ITE 12th Ed	266	DU	$T = 0.48(X) + 7.35$	62%	38%	84	51	135
<b>Total:</b>								107	68	175

# Appendix E: Intersection Analysis Worksheets

Intersection	
Intersection Delay, s/veh	9.1
Intersection LOS	A

Movement	EBL	EBT	EBR	WBL	WBT	WBR	NBL	NBT	NBR	SBL	SBT	SBR
Lane Configurations	↶	↷		↶	↶	↶		↷		↶	↶	↶
Traffic Vol, veh/h	0	0	0	73	4	90	0	42	35	101	99	1
Future Vol, veh/h	0	0	0	73	4	90	0	42	35	101	99	1
Peak Hour Factor	0.82	0.82	0.82	0.82	0.82	0.82	0.82	0.82	0.82	0.82	0.82	0.82
Heavy Vehicles, %	0	0	0	2	2	2	4	4	4	2	2	2
Mvmt Flow	0	0	0	89	5	110	0	51	43	123	121	1
Number of Lanes	1	1	0	1	1	1	0	1	0	1	1	1

Approach	EB	WB	NB	SB
Opposing Approach	WB	EB	SB	NB
Opposing Lanes	3	2	3	1
Conflicting Approach Left	SB	NB	EB	WB
Conflicting Lanes Left	3	1	2	3
Conflicting Approach Right	NB	SB	WB	EB
Conflicting Lanes Right	1	3	3	2
HCM Control Delay, s/veh	0	9	9	9.3
HCM LOS	-	A	A	A

Lane	NBLn1	EBLn1	EBLn2	WBLn1	WBLn2	WBLn3	SBLn1	SBLn2	SBLn3
Vol Left, %	0%	0%	0%	100%	0%	0%	100%	0%	0%
Vol Thru, %	55%	100%	100%	0%	100%	0%	0%	100%	0%
Vol Right, %	45%	0%	0%	0%	0%	100%	0%	0%	100%
Sign Control	Stop	Stop	Stop	Stop	Stop	Stop	Stop	Stop	Stop
Traffic Vol by Lane	77	0	0	73	4	90	101	99	1
LT Vol	0	0	0	73	0	0	101	0	0
Through Vol	42	0	0	0	4	0	0	99	0
RT Vol	35	0	0	0	0	90	0	0	1
Lane Flow Rate	94	0	0	89	5	110	123	121	1
Geometry Grp	6	6	6	6	6	6	5	5	5
Degree of Util (X)	0.139	0	0	0.148	0.007	0.145	0.193	0.172	0.002
Departure Headway (Hd)	5.327	5.87	5.87	5.972	5.471	4.769	5.641	5.139	4.437
Convergence, Y/N	Yes	Yes	Yes	Yes	Yes	Yes	Yes	Yes	Yes
Cap	670	0	0	599	653	750	636	697	804
Service Time	3.085	3.645	3.645	3.718	3.217	2.515	3.383	2.881	2.179
HCM Lane V/C Ratio	0.14	0	0	0.149	0.008	0.147	0.193	0.174	0.001
HCM Control Delay, s/veh	9	8.6	8.6	9.8	8.3	8.3	9.7	9	7.2
HCM Lane LOS	A	N	N	A	A	A	A	A	A
HCM 95th-tile Q	0.5	0	0	0.5	0	0.5	0.7	0.6	0

Intersection	
Intersection Delay, s/veh	8.9
Intersection LOS	A

Movement	EBL	EBT	EBR	WBL	WBT	WBR	NBL	NBT	NBR	SBL	SBT	SBR
Lane Configurations	↖	↗		↖	↗	↖		↕		↖	↗	↖
Traffic Vol, veh/h	4	2	0	44	3	108	0	92	77	78	67	0
Future Vol, veh/h	4	2	0	44	3	108	0	92	77	78	67	0
Peak Hour Factor	0.94	0.94	0.94	0.94	0.94	0.94	0.94	0.94	0.94	0.94	0.94	0.94
Heavy Vehicles, %	0	0	0	0	0	0	0	0	0	0	0	0
Mvmt Flow	4	2	0	47	3	115	0	98	82	83	71	0
Number of Lanes	1	1	0	1	1	1	0	1	0	1	1	1

Approach	EB	WB	NB	SB
Opposing Approach	WB	EB	SB	NB
Opposing Lanes	3	2	3	1
Conflicting Approach Left	SB	NB	EB	WB
Conflicting Lanes Left	3	1	2	3
Conflicting Approach Right	NB	SB	WB	EB
Conflicting Lanes Right	1	3	3	2
HCM Control Delay, s/veh	8.9	8.6	9.4	8.8
HCM LOS	A	A	A	A

Lane	NBLn1	EBLn1	EBLn2	WBLn1	WBLn2	WBLn3	SBLn1	SBLn2	SBLn3
Vol Left, %	0%	100%	0%	100%	0%	0%	100%	0%	0%
Vol Thru, %	54%	0%	100%	0%	100%	0%	0%	100%	100%
Vol Right, %	46%	0%	0%	0%	0%	100%	0%	0%	0%
Sign Control	Stop	Stop	Stop	Stop	Stop	Stop	Stop	Stop	Stop
Traffic Vol by Lane	169	4	2	44	3	108	78	67	0
LT Vol	0	4	0	44	0	0	78	0	0
Through Vol	92	0	2	0	3	0	0	67	0
RT Vol	77	0	0	0	0	108	0	0	0
Lane Flow Rate	180	4	2	47	3	115	83	71	0
Geometry Grp	6	6	6	6	6	6	5	5	5
Degree of Util (X)	0.248	0.007	0.003	0.077	0.005	0.152	0.129	0.101	0
Departure Headway (Hd)	4.967	6.288	5.782	5.958	5.455	4.75	5.579	5.077	5.077
Convergence, Y/N	Yes	Yes	Yes	Yes	Yes	Yes	Yes	Yes	Yes
Cap	721	567	616	601	655	753	642	705	0
Service Time	2.709	4.055	3.549	3.702	3.198	2.493	3.317	2.815	2.815
HCM Lane V/C Ratio	0.25	0.007	0.003	0.078	0.005	0.153	0.129	0.101	0
HCM Control Delay, s/veh	9.4	9.1	8.6	9.2	8.2	8.4	9.1	8.4	7.8
HCM Lane LOS	A	A	A	A	A	A	A	A	N
HCM 95th-tile Q	1	0	0	0.2	0	0.5	0.4	0.3	0

Intersection	
Intersection Delay, s/veh	9.4
Intersection LOS	A

Movement	EBL	EBT	EBR	WBL	WBT	WBR	NBL	NBT	NBR	SBL	SBT	SBR
Lane Configurations	↶	↷		↶	↷	↶		↷		↶	↷	↶
Traffic Vol, veh/h	0	0	0	75	4	118	0	43	36	112	102	1
Future Vol, veh/h	0	0	0	75	4	118	0	43	36	112	102	1
Peak Hour Factor	0.82	0.82	0.82	0.82	0.82	0.82	0.82	0.82	0.82	0.82	0.82	0.82
Heavy Vehicles, %	0	0	0	2	2	2	4	4	4	2	2	2
Mvmt Flow	0	0	0	91	5	144	0	52	44	137	124	1
Number of Lanes	1	1	0	1	1	1	0	1	0	1	1	1

Approach	EB	WB	NB	SB
Opposing Approach	WB	EB	SB	NB
Opposing Lanes	3	2	3	1
Conflicting Approach Left	SB	NB	EB	WB
Conflicting Lanes Left	3	1	2	3
Conflicting Approach Right	NB	SB	WB	EB
Conflicting Lanes Right	1	3	3	2
HCM Control Delay, s/veh	0	9.2	9.2	9.6
HCM LOS	-	A	A	A

Lane	NBLn1	EBLn1	EBLn2	WBLn1	WBLn2	WBLn3	SBLn1	SBLn2	SBLn3
Vol Left, %	0%	0%	0%	100%	0%	0%	100%	0%	0%
Vol Thru, %	54%	100%	100%	0%	100%	0%	0%	100%	0%
Vol Right, %	46%	0%	0%	0%	0%	100%	0%	0%	100%
Sign Control	Stop	Stop	Stop	Stop	Stop	Stop	Stop	Stop	Stop
Traffic Vol by Lane	79	0	0	75	4	118	112	102	1
LT Vol	0	0	0	75	0	0	112	0	0
Through Vol	43	0	0	0	4	0	0	102	0
RT Vol	36	0	0	0	0	118	0	0	1
Lane Flow Rate	96	0	0	91	5	144	137	124	1
Geometry Grp	6	6	6	6	6	6	5	5	5
Degree of Util (X)	0.146	0	0	0.153	0.007	0.193	0.218	0.181	0.002
Departure Headway (Hd)	5.461	6.005	6.005	6.035	5.534	4.832	5.735	5.233	4.53
Convergence, Y/N	Yes	Yes	Yes	Yes	Yes	Yes	Yes	Yes	Yes
Cap	652	0	0	593	644	738	624	683	786
Service Time	3.232	3.795	3.795	3.792	3.29	2.588	3.485	2.983	2.28
HCM Lane V/C Ratio	0.147	0	0	0.153	0.008	0.195	0.22	0.182	0.001
HCM Control Delay, s/veh	9.2	8.8	8.8	9.9	8.3	8.8	10.1	9.1	7.3
HCM Lane LOS	A	N	N	A	A	A	B	A	A
HCM 95th-tile Q	0.5	0	0	0.5	0	0.7	0.8	0.7	0

Intersection	
Intersection Delay, s/veh	9.2
Intersection LOS	A

Movement	EBL	EBT	EBR	WBL	WBT	WBR	NBL	NBT	NBR	SBL	SBT	SBR
Lane Configurations	↶	↷		↶	↶	↶		↷		↶	↶	↶
Traffic Vol, veh/h	4	2	0	45	3	124	0	95	79	100	69	0
Future Vol, veh/h	4	2	0	45	3	124	0	95	79	100	69	0
Peak Hour Factor	0.94	0.94	0.94	0.94	0.94	0.94	0.94	0.94	0.94	0.94	0.94	0.94
Heavy Vehicles, %	0	0	0	0	0	0	0	0	0	0	0	0
Mvmt Flow	4	2	0	48	3	132	0	101	84	106	73	0
Number of Lanes	1	1	0	1	1	1	0	1	0	1	1	1

Approach	EB	WB	NB	SB
Opposing Approach	WB	EB	SB	NB
Opposing Lanes	3	2	3	1
Conflicting Approach Left	SB	NB	EB	WB
Conflicting Lanes Left	3	1	2	3
Conflicting Approach Right	NB	SB	WB	EB
Conflicting Lanes Right	1	3	3	2
HCM Control Delay, s/veh	9.1	8.8	9.6	9.1
HCM LOS	A	A	A	A

Lane	NBLn1	EBLn1	EBLn2	WBLn1	WBLn2	WBLn3	SBLn1	SBLn2	SBLn3
Vol Left, %	0%	100%	0%	100%	0%	0%	100%	0%	0%
Vol Thru, %	55%	0%	100%	0%	100%	0%	0%	100%	100%
Vol Right, %	45%	0%	0%	0%	0%	100%	0%	0%	0%
Sign Control	Stop	Stop	Stop	Stop	Stop	Stop	Stop	Stop	Stop
Traffic Vol by Lane	174	4	2	45	3	124	100	69	0
LT Vol	0	4	0	45	0	0	100	0	0
Through Vol	95	0	2	0	3	0	0	69	0
RT Vol	79	0	0	0	0	124	0	0	0
Lane Flow Rate	185	4	2	48	3	132	106	73	0
Geometry Grp	6	6	6	6	6	6	5	5	5
Degree of Util (X)	0.261	0.008	0.003	0.08	0.005	0.177	0.167	0.105	0
Departure Headway (Hd)	5.075	6.424	5.918	6.053	5.549	4.843	5.636	5.134	5.134
Convergence, Y/N	Yes	Yes	Yes	Yes	Yes	Yes	Yes	Yes	Yes
Cap	705	553	600	590	642	737	635	696	0
Service Time	2.827	4.206	3.699	3.809	3.305	2.599	3.382	2.88	2.88
HCM Lane V/C Ratio	0.262	0.007	0.003	0.081	0.005	0.179	0.167	0.105	0
HCM Control Delay, s/veh	9.6	9.3	8.7	9.3	8.3	8.6	9.5	8.5	7.9
HCM Lane LOS	A	A	A	A	A	A	A	A	N
HCM 95th-tile Q	1	0	0	0.3	0	0.6	0.6	0.4	0

Intersection	
Intersection Delay, s/veh	9.7
Intersection LOS	A

Movement	EBL	EBT	EBR	WBL	WBT	WBR	NBL	NBT	NBR	SBL	SBT	SBR
Lane Configurations	↶	↷		↶	↶	↶		↷		↶	↶	↶
Traffic Vol, veh/h	0	0	0	75	4	155	0	43	36	124	102	1
Future Vol, veh/h	0	0	0	75	4	155	0	43	36	124	102	1
Peak Hour Factor	0.82	0.82	0.82	0.82	0.82	0.82	0.82	0.82	0.82	0.82	0.82	0.82
Heavy Vehicles, %	0	0	0	2	2	2	4	4	4	2	2	2
Mvmt Flow	0	0	0	91	5	189	0	52	44	151	124	1
Number of Lanes	1	1	0	1	1	1	0	1	0	1	1	1

Approach	EB	WB	NB	SB
Opposing Approach	WB	EB	SB	NB
Opposing Lanes	3	2	3	1
Conflicting Approach Left	SB	NB	EB	WB
Conflicting Lanes Left	3	1	2	3
Conflicting Approach Right	NB	SB	WB	EB
Conflicting Lanes Right	1	3	3	2
HCM Control Delay, s/veh	0	9.6	9.4	9.9
HCM LOS	-	A	A	A

Lane	NBLn1	EBLn1	EBLn2	WBLn1	WBLn2	WBLn3	SBLn1	SBLn2	SBLn3
Vol Left, %	0%	0%	0%	100%	0%	0%	100%	0%	0%
Vol Thru, %	54%	100%	100%	0%	100%	0%	0%	100%	0%
Vol Right, %	46%	0%	0%	0%	0%	100%	0%	0%	100%
Sign Control	Stop	Stop	Stop	Stop	Stop	Stop	Stop	Stop	Stop
Traffic Vol by Lane	79	0	0	75	4	155	124	102	1
LT Vol	0	0	0	75	0	0	124	0	0
Through Vol	43	0	0	0	4	0	0	102	0
RT Vol	36	0	0	0	0	155	0	0	1
Lane Flow Rate	96	0	0	91	5	189	151	124	1
Geometry Grp	6	6	6	6	6	6	5	5	5
Degree of Util (X)	0.15	0	0	0.155	0.008	0.257	0.245	0.184	0.002
Departure Headway (Hd)	5.614	6.253	6.253	6.091	5.589	4.887	5.842	5.339	4.636
Convergence, Y/N	Yes	Yes	Yes	Yes	Yes	Yes	Yes	Yes	Yes
Cap	633	0	0	586	637	730	611	668	765
Service Time	3.402	3.953	3.953	3.852	3.351	2.649	3.609	3.106	2.403
HCM Lane V/C Ratio	0.152	0	0	0.155	0.008	0.259	0.247	0.186	0.001
HCM Control Delay, s/veh	9.4	9	9	10	8.4	9.4	10.5	9.3	7.4
HCM Lane LOS	A	N	N	A	A	A	B	A	A
HCM 95th-tile Q	0.5	0	0	0.5	0	1	1	0.7	0

Intersection	
Intersection Delay, s/veh	9.6
Intersection LOS	A

Movement	EBL	EBT	EBR	WBL	WBT	WBR	NBL	NBT	NBR	SBL	SBT	SBR
Lane Configurations	↖	↗		↖	↖	↖		↕		↖	↖	↖
Traffic Vol, veh/h	4	2	0	45	3	148	0	95	79	137	69	0
Future Vol, veh/h	4	2	0	45	3	148	0	95	79	137	69	0
Peak Hour Factor	0.94	0.94	0.94	0.94	0.94	0.94	0.94	0.94	0.94	0.94	0.94	0.94
Heavy Vehicles, %	0	0	0	0	0	0	0	0	0	0	0	0
Mvmt Flow	4	2	0	48	3	157	0	101	84	146	73	0
Number of Lanes	1	1	0	1	1	1	0	1	0	1	1	1

Approach	EB	WB	NB	SB
Opposing Approach	WB	EB	SB	NB
Opposing Lanes	3	2	3	1
Conflicting Approach Left	SB	NB	EB	WB
Conflicting Lanes Left	3	1	2	3
Conflicting Approach Right	NB	SB	WB	EB
Conflicting Lanes Right	1	3	3	2
HCM Control Delay, s/veh	9.3	9.2	9.9	9.7
HCM LOS	A	A	A	A

Lane	NBLn1	EBLn1	EBLn2	WBLn1	WBLn2	WBLn3	SBLn1	SBLn2	SBLn3
Vol Left, %	0%	100%	0%	100%	0%	0%	100%	0%	0%
Vol Thru, %	55%	0%	100%	0%	100%	0%	0%	100%	100%
Vol Right, %	45%	0%	0%	0%	0%	100%	0%	0%	0%
Sign Control	Stop	Stop	Stop	Stop	Stop	Stop	Stop	Stop	Stop
Traffic Vol by Lane	174	4	2	45	3	148	137	69	0
LT Vol	0	4	0	45	0	0	137	0	0
Through Vol	95	0	2	0	3	0	0	69	0
RT Vol	79	0	0	0	0	148	0	0	0
Lane Flow Rate	185	4	2	48	3	157	146	73	0
Geometry Grp	6	6	6	6	6	6	5	5	5
Degree of Util (X)	0.269	0.008	0.004	0.082	0.005	0.217	0.231	0.106	0
Departure Headway (Hd)	5.236	6.712	6.204	6.18	5.676	4.969	5.709	5.207	5.207
Convergence, Y/N	Yes	Yes	Yes	Yes	Yes	Yes	Yes	Yes	Yes
Cap	681	536	580	577	627	716	627	684	0
Service Time	3.005	4.412	3.904	3.949	3.444	2.737	3.471	2.969	2.969
HCM Lane V/C Ratio	0.272	0.007	0.003	0.083	0.005	0.219	0.233	0.107	0
HCM Control Delay, s/veh	9.9	9.5	8.9	9.5	8.5	9.1	10.2	8.6	8
HCM Lane LOS	A	A	A	A	A	A	B	A	N
HCM 95th-tile Q	1.1	0	0	0.3	0	0.8	0.9	0.4	0

Intersection	
Intersection Delay, s/veh	10
Intersection LOS	A

Movement	EBL	EBT	EBR	WBL	WBT	WBR	NBL	NBT	NBR	SBL	SBT	SBR
Lane Configurations	↖	↗		↖	↖	↖		↕		↖	↖	↖
Traffic Vol, veh/h	0	0	0	89	5	135	0	51	43	131	121	1
Future Vol, veh/h	0	0	0	89	5	135	0	51	43	131	121	1
Peak Hour Factor	0.82	0.82	0.82	0.82	0.82	0.82	0.82	0.82	0.82	0.82	0.82	0.82
Heavy Vehicles, %	0	0	0	2	2	2	4	4	4	2	2	2
Mvmt Flow	0	0	0	109	6	165	0	62	52	160	148	1
Number of Lanes	1	1	0	1	1	1	0	1	0	1	1	1

Approach	EB	WB	NB	SB
Opposing Approach	WB	EB	SB	NB
Opposing Lanes	3	2	3	1
Conflicting Approach Left	SB	NB	EB	WB
Conflicting Lanes Left	3	1	2	3
Conflicting Approach Right	NB	SB	WB	EB
Conflicting Lanes Right	1	3	3	2
HCM Control Delay, s/veh	0	9.8	9.8	10.2
HCM LOS	-	A	A	B

Lane	NBLn1	EBLn1	EBLn2	WBLn1	WBLn2	WBLn3	SBLn1	SBLn2	SBLn3
Vol Left, %	0%	0%	0%	100%	0%	0%	100%	0%	0%
Vol Thru, %	54%	100%	100%	0%	100%	0%	0%	100%	0%
Vol Right, %	46%	0%	0%	0%	0%	100%	0%	0%	100%
Sign Control	Stop	Stop	Stop	Stop	Stop	Stop	Stop	Stop	Stop
Traffic Vol by Lane	94	0	0	89	5	135	131	121	1
LT Vol	0	0	0	89	0	0	131	0	0
Through Vol	51	0	0	0	5	0	0	121	0
RT Vol	43	0	0	0	0	135	0	0	1
Lane Flow Rate	115	0	0	109	6	165	160	148	1
Geometry Grp	6	6	6	6	6	6	5	5	5
Degree of Util (X)	0.184	0	0	0.188	0.01	0.229	0.26	0.22	0.002
Departure Headway (Hd)	5.777	6.412	6.412	6.22	5.718	5.016	5.868	5.366	4.662
Convergence, Y/N	Yes	Yes	Yes	Yes	Yes	Yes	Yes	Yes	Yes
Cap	625	0	0	573	621	708	607	664	760
Service Time	3.477	4.118	4.118	4.004	3.502	2.799	3.646	3.143	2.44
HCM Lane V/C Ratio	0.184	0	0	0.19	0.01	0.233	0.264	0.223	0.001
HCM Control Delay, s/veh	9.8	9.1	9.1	10.5	8.6	9.3	10.7	9.7	7.4
HCM Lane LOS	A	N	N	B	A	A	B	A	A
HCM 95th-tile Q	0.7	0	0	0.7	0	0.9	1	0.8	0

Intersection	
Intersection Delay, s/veh	9.8
Intersection LOS	A

Movement	EBL	EBT	EBR	WBL	WBT	WBR	NBL	NBT	NBR	SBL	SBT	SBR
Lane Configurations	↶	↷		↶	↶	↶		↷		↶	↶	↶
Traffic Vol, veh/h	5	2	0	54	4	145	0	112	94	115	82	0
Future Vol, veh/h	5	2	0	54	4	145	0	112	94	115	82	0
Peak Hour Factor	0.94	0.94	0.94	0.94	0.94	0.94	0.94	0.94	0.94	0.94	0.94	0.94
Heavy Vehicles, %	0	0	0	0	0	0	0	0	0	0	0	0
Mvmt Flow	5	2	0	57	4	154	0	119	100	122	87	0
Number of Lanes	1	1	0	1	1	1	0	1	0	1	1	1

Approach	EB	WB	NB	SB
Opposing Approach	WB	EB	SB	NB
Opposing Lanes	3	2	3	1
Conflicting Approach Left	SB	NB	EB	WB
Conflicting Lanes Left	3	1	2	3
Conflicting Approach Right	NB	SB	WB	EB
Conflicting Lanes Right	1	3	3	2
HCM Control Delay, s/veh	9.4	9.3	10.5	9.5
HCM LOS	A	A	B	A

Lane	NBLn1	EBLn1	EBLn2	WBLn1	WBLn2	WBLn3	SBLn1	SBLn2	SBLn3
Vol Left, %	0%	100%	0%	100%	0%	0%	100%	0%	0%
Vol Thru, %	54%	0%	100%	0%	100%	0%	0%	100%	100%
Vol Right, %	46%	0%	0%	0%	0%	100%	0%	0%	0%
Sign Control	Stop	Stop	Stop	Stop	Stop	Stop	Stop	Stop	Stop
Traffic Vol by Lane	206	5	2	54	4	145	115	82	0
LT Vol	0	5	0	54	0	0	115	0	0
Through Vol	112	0	2	0	4	0	0	82	0
RT Vol	94	0	0	0	0	145	0	0	0
Lane Flow Rate	219	5	2	57	4	154	122	87	0
Geometry Grp	6	6	6	6	6	6	5	5	5
Degree of Util (X)	0.319	0.01	0.004	0.1	0.007	0.216	0.196	0.128	0
Departure Headway (Hd)	5.243	6.815	6.306	6.247	5.742	5.035	5.774	5.272	5.272
Convergence, Y/N	Yes	Yes	Yes	Yes	Yes	Yes	Yes	Yes	Yes
Cap	679	528	571	570	619	706	618	675	0
Service Time	3.02	4.515	4.006	4.025	3.52	2.812	3.547	3.045	3.045
HCM Lane V/C Ratio	0.323	0.009	0.004	0.1	0.006	0.218	0.197	0.129	0
HCM Control Delay, s/veh	10.5	9.6	9	9.7	8.6	9.2	10	8.8	8
HCM Lane LOS	B	A	A	A	A	A	A	A	N
HCM 95th-tile Q	1.4	0	0	0.3	0	0.8	0.7	0.4	0

Intersection	
Intersection Delay, s/veh	10.3
Intersection LOS	B

Movement	EBL	EBT	EBR	WBL	WBT	WBR	NBL	NBT	NBR	SBL	SBT	SBR
Lane Configurations	↶	↷		↶	↶	↶		↷		↶	↶	↶
Traffic Vol, veh/h	0	0	0	89	5	172	0	51	43	143	121	1
Future Vol, veh/h	0	0	0	89	5	172	0	51	43	143	121	1
Peak Hour Factor	0.82	0.82	0.82	0.82	0.82	0.82	0.82	0.82	0.82	0.82	0.82	0.82
Heavy Vehicles, %	0	0	0	2	2	2	4	4	4	2	2	2
Mvmt Flow	0	0	0	109	6	210	0	62	52	174	148	1
Number of Lanes	1	1	0	1	1	1	0	1	0	1	1	1

Approach	EB	WB	NB	SB
Opposing Approach	WB	EB	SB	NB
Opposing Lanes	3	2	3	1
Conflicting Approach Left	SB	NB	EB	WB
Conflicting Lanes Left	3	1	2	3
Conflicting Approach Right	NB	SB	WB	EB
Conflicting Lanes Right	1	3	3	2
HCM Control Delay, s/veh	0	10.1	10	10.6
HCM LOS	-	B	A	B

Lane	NBLn1	EBLn1	EBLn2	WBLn1	WBLn2	WBLn3	SBLn1	SBLn2	SBLn3
Vol Left, %	0%	0%	0%	100%	0%	0%	100%	0%	0%
Vol Thru, %	54%	100%	100%	0%	100%	0%	0%	100%	0%
Vol Right, %	46%	0%	0%	0%	0%	100%	0%	0%	100%
Sign Control	Stop	Stop	Stop	Stop	Stop	Stop	Stop	Stop	Stop
Traffic Vol by Lane	94	0	0	89	5	172	143	121	1
LT Vol	0	0	0	89	0	0	143	0	0
Through Vol	51	0	0	0	5	0	0	121	0
RT Vol	43	0	0	0	0	172	0	0	1
Lane Flow Rate	115	0	0	109	6	210	174	148	1
Geometry Grp	6	6	6	6	6	6	5	5	5
Degree of Util (X)	0.189	0	0	0.189	0.01	0.296	0.29	0.224	0.002
Departure Headway (Hd)	5.95	6.577	6.577	6.277	5.775	5.073	5.978	5.475	4.772
Convergence, Y/N	Yes	Yes	Yes	Yes	Yes	Yes	Yes	Yes	Yes
Cap	606	0	0	567	613	701	595	649	740
Service Time	3.65	4.283	4.283	4.071	3.569	2.866	3.772	3.269	2.564
HCM Lane V/C Ratio	0.19	0	0	0.192	0.01	0.3	0.292	0.228	0.001
HCM Control Delay, s/veh	10	9.3	9.3	10.5	8.6	10	11.2	9.9	7.6
HCM Lane LOS	A	N	N	B	A	A	B	A	A
HCM 95th-tile Q	0.7	0	0	0.7	0	1.2	1.2	0.9	0

Intersection	
Intersection Delay, s/veh	10.2
Intersection LOS	B

Movement	EBL	EBT	EBR	WBL	WBT	WBR	NBL	NBT	NBR	SBL	SBT	SBR
Lane Configurations	↖	↗		↖	↗	↖		↕		↖	↗	↖
Traffic Vol, veh/h	5	2	0	54	4	169	0	112	94	152	82	0
Future Vol, veh/h	5	2	0	54	4	169	0	112	94	152	82	0
Peak Hour Factor	0.94	0.94	0.94	0.94	0.94	0.94	0.94	0.94	0.94	0.94	0.94	0.94
Heavy Vehicles, %	0	0	0	0	0	0	0	0	0	0	0	0
Mvmt Flow	5	2	0	57	4	180	0	119	100	162	87	0
Number of Lanes	1	1	0	1	1	1	0	1	0	1	1	1

Approach	EB	WB	NB	SB
Opposing Approach	WB	EB	SB	NB
Opposing Lanes	3	2	3	1
Conflicting Approach Left	SB	NB	EB	WB
Conflicting Lanes Left	3	1	2	3
Conflicting Approach Right	NB	SB	WB	EB
Conflicting Lanes Right	1	3	3	2
HCM Control Delay, s/veh	9.6	9.8	10.9	10.1
HCM LOS	A	A	B	B

Lane	NBLn1	EBLn1	EBLn2	WBLn1	WBLn2	WBLn3	SBLn1	SBLn2	SBLn3
Vol Left, %	0%	100%	0%	100%	0%	0%	100%	0%	0%
Vol Thru, %	54%	0%	100%	0%	100%	0%	0%	100%	100%
Vol Right, %	46%	0%	0%	0%	0%	100%	0%	0%	0%
Sign Control	Stop	Stop	Stop	Stop	Stop	Stop	Stop	Stop	Stop
Traffic Vol by Lane	206	5	2	54	4	169	152	82	0
LT Vol	0	5	0	54	0	0	152	0	0
Through Vol	112	0	2	0	4	0	0	82	0
RT Vol	94	0	0	0	0	169	0	0	0
Lane Flow Rate	219	5	2	57	4	180	162	87	0
Geometry Grp	6	6	6	6	6	6	5	5	5
Degree of Util (X)	0.329	0.01	0.004	0.102	0.007	0.258	0.263	0.13	0
Departure Headway (Hd)	5.405	7.033	6.523	6.374	5.869	5.162	5.851	5.348	5.348
Convergence, Y/N	Yes	Yes	Yes	Yes	Yes	Yes	Yes	Yes	Yes
Cap	657	512	552	557	604	687	608	663	0
Service Time	3.203	4.733	4.223	4.17	3.664	2.956	3.64	3.138	3.138
HCM Lane V/C Ratio	0.333	0.01	0.004	0.102	0.007	0.262	0.266	0.131	0
HCM Control Delay, s/veh	10.9	9.8	9.2	9.9	8.7	9.8	10.7	8.9	8.1
HCM Lane LOS	B	A	A	A	A	A	B	A	N
HCM 95th-tile Q	1.4	0	0	0.3	0	1	1.1	0.4	0

Intersection												
Int Delay, s/veh	3.6											
Movement	EBL	EBT	EBR	WBL	WBT	WBR	NBL	NBT	NBR	SBL	SBT	SBR
Lane Configurations	↗	↗↘		↗	↗↘		↗		↗	↗	↘	
Traffic Vol, veh/h	13	365	5	70	529	9	0	0	163	25	0	11
Future Vol, veh/h	13	365	5	70	529	9	0	0	163	25	0	11
Conflicting Peds, #/hr	0	0	0	0	0	0	0	0	0	0	0	0
Sign Control	Free	Free	Free	Free	Free	Free	Stop	Stop	Stop	Stop	Stop	Stop
RT Channelized	-	-	None	-	-	None	-	-	None	-	-	None
Storage Length	100	-	-	175	-	-	0	-	0	100	-	-
Veh in Median Storage, #	-	0	-	-	0	-	-	1	-	-	1	-
Grade, %	-	0	-	-	0	-	-	0	-	-	0	-
Peak Hour Factor	60	60	60	60	60	60	60	60	60	60	60	60
Heavy Vehicles, %	1	1	1	1	1	1	0	0	0	0	0	0
Mvmt Flow	22	608	8	117	882	15	0	0	272	42	0	18

Major/Minor	Major1			Major2			Minor1			Minor2		
Conflicting Flow All	897	0	0	617	0	0	1330	-	308	1470	1783	448
Stage 1	-	-	-	-	-	-	656	-	-	1123	1123	-
Stage 2	-	-	-	-	-	-	674	-	-	348	660	-
Critical Hdwy	4.12	-	-	4.12	-	-	7.5	-	6.9	7.5	6.5	6.9
Critical Hdwy Stg 1	-	-	-	-	-	-	6.5	-	-	6.5	5.5	-
Critical Hdwy Stg 2	-	-	-	-	-	-	6.5	-	-	6.5	5.5	-
Follow-up Hdwy	2.21	-	-	2.21	-	-	3.5	-	3.3	3.5	4	3.3
Pot Cap-1 Maneuver	759	-	-	966	-	-	115	0	694	90	83	563
Stage 1	-	-	-	-	-	-	426	0	-	223	283	-
Stage 2	-	-	-	-	-	-	415	0	-	647	463	-
Platoon blocked, %	-	-	-	-	-	-	-	-	-	-	-	-
Mov Cap-1 Maneuver	759	-	-	966	-	-	95	-	694	47	71	563
Mov Cap-2 Maneuver	-	-	-	-	-	-	211	-	-	124	162	-
Stage 1	-	-	-	-	-	-	414	-	-	196	249	-
Stage 2	-	-	-	-	-	-	353	-	-	382	450	-

Approach	EB			WB			NB			SB		
HCM Ctrl Dly, s/v	0.34			1.06			13.49			37.02		
HCM LOS							B			E		

Minor Lane/Major Mvmt	NBLn1	NBLn2	EBL	EBT	EBR	WBL	WBT	WBR	SBLn1	SBLn2
Capacity (veh/h)	-	694	759	-	-	966	-	-	124	563
HCM Lane V/C Ratio	-	0.392	0.029	-	-	0.121	-	-	0.337	0.033
HCM Ctrl Dly (s/v)	0	13.5	9.9	-	-	9.2	-	-	48.2	11.6
HCM Lane LOS		A	B	A	-	A	-	-	E	B
HCM 95th %tile Q(veh)	-	1.9	0.1	-	-	0.4	-	-	1.3	0.1

Intersection												
Int Delay, s/veh	2											
Movement	EBL	EBT	EBR	WBL	WBT	WBR	NBL	NBT	NBR	SBL	SBT	SBR
Lane Configurations	↗	↗↘		↗	↗↘		↗		↗	↗	↘	
Traffic Vol, veh/h	3	204	5	30	166	22	1	0	40	31	0	2
Future Vol, veh/h	3	204	5	30	166	22	1	0	40	31	0	2
Conflicting Peds, #/hr	0	0	0	0	0	0	0	0	0	0	0	0
Sign Control	Free	Free	Free	Free	Free	Free	Stop	Stop	Stop	Stop	Stop	Stop
RT Channelized	-	-	None	-	-	None	-	-	None	-	-	None
Storage Length	100	-	-	175	-	-	0	-	0	100	-	-
Veh in Median Storage, #	-	0	-	-	0	-	-	1	-	-	1	-
Grade, %	-	0	-	-	0	-	-	0	-	-	0	-
Peak Hour Factor	93	93	93	93	93	93	93	93	93	93	93	93
Heavy Vehicles, %	0	0	0	0	0	0	0	0	0	0	0	0
Mvmt Flow	3	219	5	32	178	24	1	0	43	33	0	2

Major/Minor	Major1			Major2			Minor1			Minor2		
Conflicting Flow All	202	0	0	225	0	0	382	-	112	371	486	101
Stage 1	-	-	-	-	-	-	228	-	-	255	255	-
Stage 2	-	-	-	-	-	-	154	-	-	116	231	-
Critical Hdwy	4.1	-	-	4.1	-	-	7.5	-	6.9	7.5	6.5	6.9
Critical Hdwy Stg 1	-	-	-	-	-	-	6.5	-	-	6.5	5.5	-
Critical Hdwy Stg 2	-	-	-	-	-	-	6.5	-	-	6.5	5.5	-
Follow-up Hdwy	2.2	-	-	2.2	-	-	3.5	-	3.3	3.5	4	3.3
Pot Cap-1 Maneuver	1382	-	-	1356	-	-	555	0	926	566	484	941
Stage 1	-	-	-	-	-	-	759	0	-	733	700	-
Stage 2	-	-	-	-	-	-	839	0	-	882	717	-
Platoon blocked, %		-	-		-	-						
Mov Cap-1 Maneuver	1382	-	-	1356	-	-	540	-	926	525	472	941
Mov Cap-2 Maneuver	-	-	-	-	-	-	603	-	-	583	527	-
Stage 1	-	-	-	-	-	-	758	-	-	716	683	-
Stage 2	-	-	-	-	-	-	817	-	-	839	715	-

Approach	EB			WB			NB			SB		
HCM Ctrl Dly, s/v	0.11			1.06			9.13			11.38		
HCM LOS							A			B		

Minor Lane/Major Mvmt	NBLn1	NBLn2	EBL	EBT	EBR	WBL	WBT	WBR	SBLn1	SBLn2
Capacity (veh/h)	603	926	1382	-	-	1356	-	-	583	941
HCM Lane V/C Ratio	0.002	0.046	0.002	-	-	0.024	-	-	0.057	0.002
HCM Ctrl Dly (s/v)	11	9.1	7.6	-	-	7.7	-	-	11.5	8.8
HCM Lane LOS	B	A	A	-	-	A	-	-	B	A
HCM 95th %tile Q(veh)	0	0.1	0	-	-	0.1	-	-	0.2	0

Intersection												
Int Delay, s/veh	3.9											
Movement	EBL	EBT	EBR	WBL	WBT	WBR	NBL	NBT	NBR	SBL	SBT	SBR
Lane Configurations	↗	↗↘		↗	↗↘		↗		↗	↗	↘	
Traffic Vol, veh/h	13	423	5	72	559	9	0	0	168	26	0	11
Future Vol, veh/h	13	423	5	72	559	9	0	0	168	26	0	11
Conflicting Peds, #/hr	0	0	0	0	0	0	0	0	0	0	0	0
Sign Control	Free	Free	Free	Free	Free	Free	Stop	Stop	Stop	Stop	Stop	Stop
RT Channelized	-	-	None	-	-	None	-	-	None	-	-	None
Storage Length	100	-	-	175	-	-	0	-	0	100	-	-
Veh in Median Storage, #	-	0	-	-	0	-	-	1	-	-	1	-
Grade, %	-	0	-	-	0	-	-	0	-	-	0	-
Peak Hour Factor	60	60	60	60	60	60	60	60	60	60	60	60
Heavy Vehicles, %	1	1	1	1	1	1	0	0	0	0	0	0
Mvmt Flow	22	705	8	120	932	15	0	0	280	43	0	18

Major/Minor	Major1			Major2			Minor1			Minor2		
Conflicting Flow All	947	0	0	713	0	0	1458	-	357	1575	1936	473
Stage 1	-	-	-	-	-	-	753	-	-	1179	1179	-
Stage 2	-	-	-	-	-	-	706	-	-	396	757	-
Critical Hdwy	4.12	-	-	4.12	-	-	7.5	-	6.9	7.5	6.5	6.9
Critical Hdwy Stg 1	-	-	-	-	-	-	6.5	-	-	6.5	5.5	-
Critical Hdwy Stg 2	-	-	-	-	-	-	6.5	-	-	6.5	5.5	-
Follow-up Hdwy	2.21	-	-	2.21	-	-	3.5	-	3.3	3.5	4	3.3
Pot Cap-1 Maneuver	727	-	-	889	-	-	92	0	646	76	66	543
Stage 1	-	-	-	-	-	-	373	0	-	206	267	-
Stage 2	-	-	-	-	-	-	397	0	-	606	419	-
Platoon blocked, %	-	-	-	-	-	-	-	-	-	-	-	-
Mov Cap-1 Maneuver	727	-	-	889	-	-	75	-	646	~ 36	56	543
Mov Cap-2 Maneuver	-	-	-	-	-	-	186	-	-	105	142	-
Stage 1	-	-	-	-	-	-	362	-	-	178	231	-
Stage 2	-	-	-	-	-	-	332	-	-	333	406	-

Approach	EB			WB			NB			SB		
HCM Ctrl Dly, s/v	0.3			1.09			14.78			46.92		
HCM LOS							B			E		

Minor Lane/Major Mvmt	NBLn1	NBLn2	EBL	EBT	EBR	WBL	WBT	WBR	SBLn1	SBLn2
Capacity (veh/h)	-	646	727	-	-	889	-	-	105	543
HCM Lane V/C Ratio	-	0.434	0.03	-	-	0.135	-	-	0.414	0.034
HCM Ctrl Dly (s/v)	0	14.8	10.1	-	-	9.7	-	-	61.8	11.9
HCM Lane LOS		A	B	B	-	A	-	-	F	B
HCM 95th %tile Q(veh)	-	2.2	0.1	-	-	0.5	-	-	1.7	0.1

Notes	
-: Volume exceeds capacity	\$: Delay exceeds 300s
+: Computation Not Defined	*: All major volume in platoon

Intersection												
Int Delay, s/veh	1.8											
Movement	EBL	EBT	EBR	WBL	WBT	WBR	NBL	NBT	NBR	SBL	SBT	SBR
Lane Configurations	↖	↖↗		↖	↖↗		↖		↖↗	↖	↗	
Traffic Vol, veh/h	3	234	5	31	208	23	1	0	41	32	0	2
Future Vol, veh/h	3	234	5	31	208	23	1	0	41	32	0	2
Conflicting Peds, #/hr	0	0	0	0	0	0	0	0	0	0	0	0
Sign Control	Free	Free	Free	Free	Free	Free	Stop	Stop	Stop	Stop	Stop	Stop
RT Channelized	-	-	None	-	-	None	-	-	None	-	-	None
Storage Length	100	-	-	175	-	-	0	-	0	100	-	-
Veh in Median Storage, #	-	0	-	-	0	-	-	1	-	-	1	-
Grade, %	-	0	-	-	0	-	-	0	-	-	0	-
Peak Hour Factor	93	93	93	93	93	93	93	93	93	93	93	93
Heavy Vehicles, %	0	0	0	0	0	0	0	0	0	0	0	0
Mvmt Flow	3	252	5	33	224	25	1	0	44	34	0	2

Major/Minor	Major1			Major2			Minor1			Minor2		
Conflicting Flow All	248	0	0	257	0	0	439	-	128	435	566	124
Stage 1	-	-	-	-	-	-	261	-	-	303	303	-
Stage 2	-	-	-	-	-	-	178	-	-	132	263	-
Critical Hdwy	4.1	-	-	4.1	-	-	7.5	-	6.9	7.5	6.5	6.9
Critical Hdwy Stg 1	-	-	-	-	-	-	6.5	-	-	6.5	5.5	-
Critical Hdwy Stg 2	-	-	-	-	-	-	6.5	-	-	6.5	5.5	-
Follow-up Hdwy	2.2	-	-	2.2	-	-	3.5	-	3.3	3.5	4	3.3
Pot Cap-1 Maneuver	1329	-	-	1320	-	-	506	0	904	510	436	910
Stage 1	-	-	-	-	-	-	727	0	-	687	667	-
Stage 2	-	-	-	-	-	-	812	0	-	863	694	-
Platoon blocked, %	-	-	-	-	-	-	-	-	-	-	-	-
Mov Cap-1 Maneuver	1329	-	-	1320	-	-	491	-	904	471	424	910
Mov Cap-2 Maneuver	-	-	-	-	-	-	567	-	-	541	492	-
Stage 1	-	-	-	-	-	-	725	-	-	670	651	-
Stage 2	-	-	-	-	-	-	789	-	-	819	692	-

Approach	EB		WB		NB		SB	
HCM Ctrl Dly, s/v	0.1		0.92		9.24		11.92	
HCM LOS					A		B	

Minor Lane/Major Mvmt	NBLn1	NBLn2	EBL	EBT	EBR	WBL	WBT	WBR	SBLn1	SBLn2
Capacity (veh/h)	567	904	1329	-	-	1320	-	-	541	910
HCM Lane V/C Ratio	0.002	0.049	0.002	-	-	0.025	-	-	0.064	0.002
HCM Ctrl Dly (s/v)	11.4	9.2	7.7	-	-	7.8	-	-	12.1	9
HCM Lane LOS	B	A	A	-	-	A	-	-	B	A
HCM 95th %tile Q(veh)	0	0.2	0	-	-	0.1	-	-	0.2	0

Intersection												
Int Delay, s/veh	2.9											
Movement	EBL	EBT	EBR	WBL	WBT	WBR	NBL	NBT	NBR	SBL	SBT	SBR
Lane Configurations	↗	↗↘		↗	↗↘		↗		↗	↗	↘	
Traffic Vol, veh/h	16	432	5	72	570	10	0	0	168	0	0	38
Future Vol, veh/h	16	432	5	72	570	10	0	0	168	0	0	38
Conflicting Peds, #/hr	0	0	0	0	0	0	0	0	0	0	0	0
Sign Control	Free	Free	Free	Free	Free	Free	Stop	Stop	Stop	Stop	Stop	Stop
RT Channelized	-	-	None	-	-	None	-	-	None	-	-	None
Storage Length	100	-	-	175	-	-	0	-	0	100	-	-
Veh in Median Storage, #	-	0	-	-	0	-	-	1	-	-	1	-
Grade, %	-	0	-	-	0	-	-	0	-	-	0	-
Peak Hour Factor	60	60	60	60	60	60	60	60	60	60	60	60
Heavy Vehicles, %	1	1	1	1	1	1	0	0	0	0	0	0
Mvmt Flow	27	720	8	120	950	17	0	0	280	0	0	63

Major/Minor	Major1			Major2			Minor1			Minor2		
Conflicting Flow All	967	0	0	728	0	0	1493	-	364	1612	1980	483
Stage 1	-	-	-	-	-	-	778	-	-	1198	1198	-
Stage 2	-	-	-	-	-	-	715	-	-	413	782	-
Critical Hdwy	4.12	-	-	4.12	-	-	7.5	-	6.9	7.5	6.5	6.9
Critical Hdwy Stg 1	-	-	-	-	-	-	6.5	-	-	6.5	5.5	-
Critical Hdwy Stg 2	-	-	-	-	-	-	6.5	-	-	6.5	5.5	-
Follow-up Hdwy	2.21	-	-	2.21	-	-	3.5	-	3.3	3.5	4	3.3
Pot Cap-1 Maneuver	714	-	-	878	-	-	87	0	638	71	62	535
Stage 1	-	-	-	-	-	-	360	0	-	200	261	-
Stage 2	-	-	-	-	-	-	392	0	-	592	408	-
Platoon blocked, %	-	-	-	-	-	-	-	-	-	-	-	-
Mov Cap-1 Maneuver	714	-	-	878	-	-	64	-	638	33	52	535
Mov Cap-2 Maneuver	-	-	-	-	-	-	168	-	-	100	136	-
Stage 1	-	-	-	-	-	-	347	-	-	173	225	-
Stage 2	-	-	-	-	-	-	299	-	-	320	393	-

Approach	EB			WB			NB			SB		
HCM Ctrl Dly, s/v	0.36			1.08			14.97			12.64		
HCM LOS							B			B		

Minor Lane/Major Mvmt	NBLn1	NBLn2	EBL	EBT	EBR	WBL	WBT	WBR	SBLn1	SBLn2
Capacity (veh/h)	-	638	714	-	-	878	-	-	-	535
HCM Lane V/C Ratio	-	0.439	0.037	-	-	0.137	-	-	-	0.118
HCM Ctrl Dly (s/v)	0	15	10.2	-	-	9.7	-	-	0	12.6
HCM Lane LOS	A	B	B	-	-	A	-	-	A	B
HCM 95th %tile Q(veh)	-	2.2	0.1	-	-	0.5	-	-	-	0.4

Intersection												
Int Delay, s/veh	2											
Movement	EBL	EBT	EBR	WBL	WBT	WBR	NBL	NBT	NBR	SBL	SBT	SBR
Lane Configurations	↗	↗↘		↗	↗↘		↗		↗	↗	↘	
Traffic Vol, veh/h	13	262	5	31	215	26	1	0	41	32	0	19
Future Vol, veh/h	13	262	5	31	215	26	1	0	41	32	0	19
Conflicting Peds, #/hr	0	0	0	0	0	0	0	0	0	0	0	0
Sign Control	Free	Free	Free	Free	Free	Free	Stop	Stop	Stop	Stop	Stop	Stop
RT Channelized	-	-	None	-	-	None	-	-	None	-	-	None
Storage Length	100	-	-	175	-	-	0	-	0	100	-	-
Veh in Median Storage, #	-	0	-	-	0	-	-	1	-	-	1	-
Grade, %	-	0	-	-	0	-	-	0	-	-	0	-
Peak Hour Factor	93	93	93	93	93	93	93	93	93	93	93	93
Heavy Vehicles, %	0	0	0	0	0	0	0	0	0	0	0	0
Mvmt Flow	14	282	5	33	231	28	1	0	44	34	0	20

Major/Minor	Major1			Major2			Minor1			Minor2		
Conflicting Flow All	259	0	0	287	0	0	495	-	144	481	627	130
Stage 1	-	-	-	-	-	-	312	-	-	312	312	-
Stage 2	-	-	-	-	-	-	182	-	-	169	315	-
Critical Hdwy	4.1	-	-	4.1	-	-	7.5	-	6.9	7.5	6.5	6.9
Critical Hdwy Stg 1	-	-	-	-	-	-	6.5	-	-	6.5	5.5	-
Critical Hdwy Stg 2	-	-	-	-	-	-	6.5	-	-	6.5	5.5	-
Follow-up Hdwy	2.2	-	-	2.2	-	-	3.5	-	3.3	3.5	4	3.3
Pot Cap-1 Maneuver	1317	-	-	1287	-	-	462	0	884	473	403	903
Stage 1	-	-	-	-	-	-	679	0	-	679	661	-
Stage 2	-	-	-	-	-	-	808	0	-	822	659	-
Platoon blocked, %		-	-		-	-						
Mov Cap-1 Maneuver	1317	-	-	1287	-	-	435	-	884	433	388	903
Mov Cap-2 Maneuver	-	-	-	-	-	-	521	-	-	515	465	-
Stage 1	-	-	-	-	-	-	671	-	-	661	644	-
Stage 2	-	-	-	-	-	-	769	-	-	773	652	-

Approach	EB			WB			NB			SB		
HCM Ctrl Dly, s/v	0.36			0.9			9.35			11.22		
HCM LOS							A			B		

Minor Lane/Major Mvmt	NBLn1	NBLn2	EBL	EBT	EBR	WBL	WBT	WBR	SBLn1	SBLn2
Capacity (veh/h)	521	884	1317	-	-	1287	-	-	515	903
HCM Lane V/C Ratio	0.002	0.05	0.011	-	-	0.026	-	-	0.067	0.023
HCM Ctrl Dly (s/v)	11.9	9.3	7.8	-	-	7.9	-	-	12.5	9.1
HCM Lane LOS	B	A	A	-	-	A	-	-	B	A
HCM 95th %tile Q(veh)	0	0.2	0	-	-	0.1	-	-	0.2	0.1

Intersection												
Int Delay, s/veh	7.8											
Movement	EBL	EBT	EBR	WBL	WBT	WBR	NBL	NBT	NBR	SBL	SBT	SBR
Lane Configurations	↗	↗↘		↗	↗↘		↗		↗	↗	↘	
Traffic Vol, veh/h	16	492	6	85	659	11	0	0	199	31	0	13
Future Vol, veh/h	16	492	6	85	659	11	0	0	199	31	0	13
Conflicting Peds, #/hr	0	0	0	0	0	0	0	0	0	0	0	0
Sign Control	Free	Free	Free	Free	Free	Free	Stop	Stop	Stop	Stop	Stop	Stop
RT Channelized	-	-	None	-	-	None	-	-	None	-	-	None
Storage Length	100	-	-	175	-	-	0	-	0	100	-	-
Veh in Median Storage, #	-	0	-	-	0	-	-	1	-	-	1	-
Grade, %	-	0	-	-	0	-	-	0	-	-	0	-
Peak Hour Factor	60	60	60	60	60	60	60	60	60	60	60	60
Heavy Vehicles, %	1	1	1	1	1	1	0	0	0	0	0	0
Mvmt Flow	27	820	10	142	1098	18	0	0	332	52	0	22

Major/Minor	Major1			Major2			Minor1			Minor2		
Conflicting Flow All	1117	0	0	830	0	0	1711	-	415	1854	2274	558
Stage 1	-	-	-	-	-	-	878	-	-	1391	1391	-
Stage 2	-	-	-	-	-	-	833	-	-	463	883	-
Critical Hdwy	4.12	-	-	4.12	-	-	7.5	-	6.9	7.5	6.5	6.9
Critical Hdwy Stg 1	-	-	-	-	-	-	6.5	-	-	6.5	5.5	-
Critical Hdwy Stg 2	-	-	-	-	-	-	6.5	-	-	6.5	5.5	-
Follow-up Hdwy	2.21	-	-	2.21	-	-	3.5	-	3.3	3.5	4	3.3
Pot Cap-1 Maneuver	627	-	-	804	-	-	60	0	592	~ 47	41	478
Stage 1	-	-	-	-	-	-	313	0	-	152	211	-
Stage 2	-	-	-	-	-	-	334	0	-	553	366	-
Platoon blocked, %	-	-	-	-	-	-	-	-	-	-	-	-
Mov Cap-1 Maneuver	627	-	-	804	-	-	45	-	592	~ 16	32	478
Mov Cap-2 Maneuver	-	-	-	-	-	-	141	-	-	55	101	-
Stage 1	-	-	-	-	-	-	300	-	-	125	174	-
Stage 2	-	-	-	-	-	-	262	-	-	233	351	-

Approach	EB			WB			NB			SB		
HCM Ctrl Dly, s/v	0.34			1.17			18.55			159.14		
HCM LOS							C			F		

Minor Lane/Major Mvmt	NBLn1	NBLn2	EBL	EBT	EBR	WBL	WBT	WBR	SBLn1	SBLn2
Capacity (veh/h)	-	592	627	-	-	804	-	-	55	478
HCM Lane V/C Ratio	-	0.56	0.043	-	-	0.176	-	-	0.932	0.045
HCM Ctrl Dly (s/v)	0	18.5	11	-	-	10.4	-	-	220.5	12.9
HCM Lane LOS		A	C	B	-	B	-	-	F	B
HCM 95th %tile Q(veh)	-	3.5	0.1	-	-	0.6	-	-	4.2	0.1

Notes	
-: Volume exceeds capacity	\$: Delay exceeds 300s
+: Computation Not Defined	*: All major volume in platoon

Intersection												
Int Delay, s/veh	2											
Movement	EBL	EBT	EBR	WBL	WBT	WBR	NBL	NBT	NBR	SBL	SBT	SBR
Lane Configurations	↖	↖↗		↖	↖↗		↖		↖	↖	↗	↗
Traffic Vol, veh/h	3	204	5	30	166	22	1	0	40	31	0	2
Future Vol, veh/h	3	204	5	30	166	22	1	0	40	31	0	2
Conflicting Peds, #/hr	0	0	0	0	0	0	0	0	0	0	0	0
Sign Control	Free	Free	Free	Free	Free	Free	Stop	Stop	Stop	Stop	Stop	Stop
RT Channelized	-	-	None	-	-	None	-	-	None	-	-	None
Storage Length	100	-	-	175	-	-	0	-	0	100	-	-
Veh in Median Storage, #	-	0	-	-	0	-	-	1	-	-	1	-
Grade, %	-	0	-	-	0	-	-	0	-	-	0	-
Peak Hour Factor	93	93	93	93	93	93	93	93	93	93	93	93
Heavy Vehicles, %	0	0	0	0	0	0	0	0	0	0	0	0
Mvmt Flow	3	219	5	32	178	24	1	0	43	33	0	2

Major/Minor	Major1		Major2		Minor1		Minor2					
Conflicting Flow All	202	0	0	225	0	0	382	-	112	371	486	101
Stage 1	-	-	-	-	-	-	228	-	-	255	255	-
Stage 2	-	-	-	-	-	-	154	-	-	116	231	-
Critical Hdwy	4.1	-	-	4.1	-	-	7.5	-	6.9	7.5	6.5	6.9
Critical Hdwy Stg 1	-	-	-	-	-	-	6.5	-	-	6.5	5.5	-
Critical Hdwy Stg 2	-	-	-	-	-	-	6.5	-	-	6.5	5.5	-
Follow-up Hdwy	2.2	-	-	2.2	-	-	3.5	-	3.3	3.5	4	3.3
Pot Cap-1 Maneuver	1382	-	-	1356	-	-	555	0	926	566	484	941
Stage 1	-	-	-	-	-	-	759	0	-	733	700	-
Stage 2	-	-	-	-	-	-	839	0	-	882	717	-
Platoon blocked, %		-	-		-	-						
Mov Cap-1 Maneuver	1382	-	-	1356	-	-	540	-	926	525	472	941
Mov Cap-2 Maneuver	-	-	-	-	-	-	603	-	-	583	527	-
Stage 1	-	-	-	-	-	-	758	-	-	716	683	-
Stage 2	-	-	-	-	-	-	817	-	-	839	715	-

Approach	EB		WB		NB		SB	
HCM Ctrl Dly, s/v	0.11		1.06		9.13		11.38	
HCM LOS					A		B	

Minor Lane/Major Mvmt	NBLn1	NBLn2	EBL	EBT	EBR	WBL	WBT	WBR	SBLn1	SBLn2
Capacity (veh/h)	603	926	1382	-	-	1356	-	-	583	941
HCM Lane V/C Ratio	0.002	0.046	0.002	-	-	0.024	-	-	0.057	0.002
HCM Ctrl Dly (s/v)	11	9.1	7.6	-	-	7.7	-	-	11.5	8.8
HCM Lane LOS	B	A	A	-	-	A	-	-	B	A
HCM 95th %tile Q(veh)	0	0.1	0	-	-	0.1	-	-	0.2	0

Intersection												
Int Delay, s/veh	3.4											
Movement	EBL	EBT	EBR	WBL	WBT	WBR	NBL	NBT	NBR	SBL	SBT	SBR
Lane Configurations	↖	↖↗		↖	↖↗		↖		↖↗	↖	↗	
Traffic Vol, veh/h	19	501	6	85	670	12	0	0	199	0	0	40
Future Vol, veh/h	19	501	6	85	670	12	0	0	199	0	0	40
Conflicting Peds, #/hr	0	0	0	0	0	0	0	0	0	0	0	0
Sign Control	Free	Free	Free	Free	Free	Free	Stop	Stop	Stop	Stop	Stop	Stop
RT Channelized	-	-	None	-	-	None	-	-	None	-	-	None
Storage Length	100	-	-	175	-	-	0	-	0	100	-	-
Veh in Median Storage, #	-	0	-	-	0	-	-	1	-	-	1	-
Grade, %	-	0	-	-	0	-	-	0	-	-	0	-
Peak Hour Factor	60	60	60	60	60	60	60	60	60	60	60	60
Heavy Vehicles, %	1	1	1	1	1	1	0	0	0	0	0	0
Mvmt Flow	32	835	10	142	1117	20	0	0	332	0	0	67

Major/Minor	Major1			Major2			Minor1			Minor2		
Conflicting Flow All	1137	0	0	845	0	0	1745	-	423	1891	2318	568
Stage 1	-	-	-	-	-	-	903	-	-	1410	1410	-
Stage 2	-	-	-	-	-	-	842	-	-	481	908	-
Critical Hdwy	4.12	-	-	4.12	-	-	7.5	-	6.9	7.5	6.5	6.9
Critical Hdwy Stg 1	-	-	-	-	-	-	6.5	-	-	6.5	5.5	-
Critical Hdwy Stg 2	-	-	-	-	-	-	6.5	-	-	6.5	5.5	-
Follow-up Hdwy	2.21	-	-	2.21	-	-	3.5	-	3.3	3.5	4	3.3
Pot Cap-1 Maneuver	707	-	-	794	-	-	72	0	585	53	39	798
Stage 1	-	-	-	-	-	-	303	0	-	193	243	-
Stage 2	-	-	-	-	-	-	492	0	-	540	357	-
Platoon blocked, %	0	-	-	-	-	-	0	-	-	0	0	0
Mov Cap-1 Maneuver	707	-	-	794	-	-	52	-	585	18	30	798
Mov Cap-2 Maneuver	-	-	-	-	-	-	166	-	-	57	105	-
Stage 1	-	-	-	-	-	-	289	-	-	158	200	-
Stage 2	-	-	-	-	-	-	370	-	-	224	341	-

Approach	EB			WB			NB			SB		
HCM Ctrl Dly, s/v	0.37			1.17			18.88			9.92		
HCM LOS							C			A		

Minor Lane/Major Mvmt	NBLn1	NBLn2	EBL	EBT	EBR	WBL	WBT	WBR	SBLn1	SBLn2
Capacity (veh/h)	-	585	707	-	-	794	-	-	-	798
HCM Lane V/C Ratio	-	0.567	0.045	-	-	0.178	-	-	-	0.084
HCM Ctrl Dly (s/v)	0	18.9	10.3	-	-	10.5	-	-	0	9.9
HCM Lane LOS	A	C	B	-	-	B	-	-	A	A
HCM 95th %tile Q(veh)	-	3.5	0.1	-	-	0.6	-	-	-	0.3

Intersection												
Int Delay, s/veh	2											
Movement	EBL	EBT	EBR	WBL	WBT	WBR	NBL	NBT	NBR	SBL	SBT	SBR
Lane Configurations	↗	↗↘		↗	↗↘		↗		↗	↗	↘	↘
Traffic Vol, veh/h	14	301	6	37	247	30	1	0	49	38	0	19
Future Vol, veh/h	14	301	6	37	247	30	1	0	49	38	0	19
Conflicting Peds, #/hr	0	0	0	0	0	0	0	0	0	0	0	0
Sign Control	Free	Free	Free	Free	Free	Free	Stop	Stop	Stop	Stop	Stop	Stop
RT Channelized	-	-	None	-	-	None	-	-	None	-	-	None
Storage Length	100	-	-	175	-	-	0	-	0	100	-	-
Veh in Median Storage, #	-	0	-	-	0	-	-	1	-	-	1	-
Grade, %	-	0	-	-	0	-	-	0	-	-	0	-
Peak Hour Factor	93	93	93	93	93	93	93	93	93	93	93	93
Heavy Vehicles, %	0	0	0	0	0	0	0	0	0	0	0	0
Mvmt Flow	15	324	6	40	266	32	1	0	53	41	0	20

Major/Minor	Major1			Major2			Minor1			Minor2		
Conflicting Flow All	298	0	0	330	0	0	569	-	165	553	722	149
Stage 1	-	-	-	-	-	-	357	-	-	361	361	-
Stage 2	-	-	-	-	-	-	212	-	-	192	360	-
Critical Hdwy	4.1	-	-	4.1	-	-	7.5	-	6.9	7.5	6.5	6.9
Critical Hdwy Stg 1	-	-	-	-	-	-	6.5	-	-	6.5	5.5	-
Critical Hdwy Stg 2	-	-	-	-	-	-	6.5	-	-	6.5	5.5	-
Follow-up Hdwy	2.2	-	-	2.2	-	-	3.5	-	3.3	3.5	4	3.3
Pot Cap-1 Maneuver	1368	-	-	1241	-	-	482	0	857	495	397	*1035
Stage 1	-	-	-	-	-	-	639	0	-	731	689	-
Stage 2	-	-	-	-	-	-	901	0	-	797	630	-
Platoon blocked, %	0	-	-	-	-	-	0	-	-	0	0	0
Mov Cap-1 Maneuver	1368	-	-	1241	-	-	452	-	857	445	380	*1035
Mov Cap-2 Maneuver	-	-	-	-	-	-	525	-	-	524	456	-
Stage 1	-	-	-	-	-	-	632	-	-	707	667	-
Stage 2	-	-	-	-	-	-	854	-	-	740	623	-

Approach	EB			WB			NB			SB		
HCM Ctrl Dly, s/v	0.33			0.94			9.53			11.15		
HCM LOS							A			B		

Minor Lane/Major Mvmt	NBLn1	NBLn2	EBL	EBT	EBR	WBL	WBT	WBR	SBLn1	SBLn2
Capacity (veh/h)	525	857	1368	-	-	1241	-	-	524	1035
HCM Lane V/C Ratio	0.002	0.061	0.011	-	-	0.032	-	-	0.078	0.02
HCM Ctrl Dly (s/v)	11.9	9.5	7.7	-	-	8	-	-	12.4	8.6
HCM Lane LOS	B	A	A	-	-	A	-	-	B	A
HCM 95th %tile Q(veh)	0	0.2	0	-	-	0.1	-	-	0.3	0.1

Notes	
-: Volume exceeds capacity	\$: Delay exceeds 300s
+: Computation Not Defined	*: All major volume in platoon

Intersection						
Int Delay, s/veh	7.6					
Movement	EBL	EBR	NBL	NBT	SBT	SBR
Lane Configurations	W		W	↑	W	
Traffic Vol, veh/h	4	36	11	0	5	0
Future Vol, veh/h	4	36	11	0	5	0
Conflicting Peds, #/hr	0	0	0	0	0	0
Sign Control	Stop	Stop	Free	Free	Free	Free
RT Channelized	-	None	-	None	-	None
Storage Length	0	-	50	-	-	-
Veh in Median Storage, #	0	-	-	0	0	-
Grade, %	0	-	-	0	0	-
Peak Hour Factor	67	67	67	67	67	67
Heavy Vehicles, %	3	3	9	9	0	0
Mvmt Flow	6	54	16	0	7	0

Major/Minor	Minor2	Major1	Major2			
Conflicting Flow All	40	7	7	0	-	0
Stage 1	7	-	-	-	-	-
Stage 2	33	-	-	-	-	-
Critical Hdwy	6.43	6.23	4.19	-	-	-
Critical Hdwy Stg 1	5.43	-	-	-	-	-
Critical Hdwy Stg 2	5.43	-	-	-	-	-
Follow-up Hdwy	3.527	3.327	2.281	-	-	-
Pot Cap-1 Maneuver	969	1072	1568	-	-	-
Stage 1	1013	-	-	-	-	-
Stage 2	987	-	-	-	-	-
Platoon blocked, %				-	-	-
Mov Cap-1 Maneuver	959	1072	1568	-	-	-
Mov Cap-2 Maneuver	891	-	-	-	-	-
Stage 1	1002	-	-	-	-	-
Stage 2	987	-	-	-	-	-

Approach	EB	NB	SB
HCM Ctrl Dly, s/v	8.63	7.32	0
HCM LOS	A		

Minor Lane/Major Mvmt	NBL	NBT	EBLn1	SBT	SBR
Capacity (veh/h)	1568	-	1050	-	-
HCM Lane V/C Ratio	0.01	-	0.057	-	-
HCM Ctrl Dly (s/v)	7.3	-	8.6	-	-
HCM Lane LOS	A	-	A	-	-
HCM 95th %tile Q(veh)	0	-	0.2	-	-

Intersection						
Int Delay, s/veh	7.8					
Movement	EBL	EBR	NBL	NBT	SBT	SBR
Lane Configurations	W		W	↑	W	
Traffic Vol, veh/h	0	39	30	0	0	0
Future Vol, veh/h	0	39	30	0	0	0
Conflicting Peds, #/hr	0	0	0	0	0	0
Sign Control	Stop	Stop	Free	Free	Free	Free
RT Channelized	-	None	-	None	-	None
Storage Length	0	-	50	-	-	-
Veh in Median Storage, #	0	-	-	0	0	-
Grade, %	0	-	-	0	0	-
Peak Hour Factor	86	86	86	86	86	86
Heavy Vehicles, %	0	0	0	0	0	0
Mvmt Flow	0	45	35	0	0	0

Major/Minor	Minor2	Major1		Major2	
Conflicting Flow All	71	1	1	0	0
Stage 1	1	-	-	-	-
Stage 2	70	-	-	-	-
Critical Hdwy	6.4	6.2	4.1	-	-
Critical Hdwy Stg 1	5.4	-	-	-	-
Critical Hdwy Stg 2	5.4	-	-	-	-
Follow-up Hdwy	3.5	3.3	2.2	-	-
Pot Cap-1 Maneuver	938	1089	1635	-	-
Stage 1	1027	-	-	-	-
Stage 2	958	-	-	-	-
Platoon blocked, %				-	-
Mov Cap-1 Maneuver	918	1089	1635	-	-
Mov Cap-2 Maneuver	863	-	-	-	-
Stage 1	1005	-	-	-	-
Stage 2	958	-	-	-	-

Approach	EB	NB	SB
HCM Ctrl Dly, s/v	8.45	7.25	0
HCM LOS	A		

Minor Lane/Major Mvmt	NBL	NBT	EBLn1	SBT	SBR
Capacity (veh/h)	1635	-	1089	-	-
HCM Lane V/C Ratio	0.021	-	0.042	-	-
HCM Ctrl Dly (s/v)	7.3	-	8.4	-	-
HCM Lane LOS	A	-	A	-	-
HCM 95th %tile Q(veh)	0.1	-	0.1	-	-

Intersection						
Int Delay, s/veh	7.6					
Movement	EBL	EBR	NBL	NBT	SBT	SBR
Lane Configurations	W		W	↑	W	
Traffic Vol, veh/h	4	37	11	0	5	0
Future Vol, veh/h	4	37	11	0	5	0
Conflicting Peds, #/hr	0	0	0	0	0	0
Sign Control	Stop	Stop	Free	Free	Free	Free
RT Channelized	-	None	-	None	-	None
Storage Length	0	-	50	-	-	-
Veh in Median Storage, #	0	-	-	0	0	-
Grade, %	0	-	-	0	0	-
Peak Hour Factor	67	67	67	67	67	67
Heavy Vehicles, %	3	3	9	9	0	0
Mvmt Flow	6	55	16	0	7	0

Major/Minor	Minor2	Major1	Major2			
Conflicting Flow All	40	7	7	0	-	0
Stage 1	7	-	-	-	-	-
Stage 2	33	-	-	-	-	-
Critical Hdwy	6.43	6.23	4.19	-	-	-
Critical Hdwy Stg 1	5.43	-	-	-	-	-
Critical Hdwy Stg 2	5.43	-	-	-	-	-
Follow-up Hdwy	3.527	3.327	2.281	-	-	-
Pot Cap-1 Maneuver	969	1072	1568	-	-	-
Stage 1	1013	-	-	-	-	-
Stage 2	987	-	-	-	-	-
Platoon blocked, %				-	-	-
Mov Cap-1 Maneuver	959	1072	1568	-	-	-
Mov Cap-2 Maneuver	891	-	-	-	-	-
Stage 1	1002	-	-	-	-	-
Stage 2	987	-	-	-	-	-

Approach	EB	NB	SB
HCM Ctrl Dly, s/v	8.64	7.32	0
HCM LOS	A		

Minor Lane/Major Mvmt	NBL	NBT	EBLn1	SBT	SBR
Capacity (veh/h)	1568	-	1051	-	-
HCM Lane V/C Ratio	0.01	-	0.058	-	-
HCM Ctrl Dly (s/v)	7.3	-	8.6	-	-
HCM Lane LOS	A	-	A	-	-
HCM 95th %tile Q(veh)	0	-	0.2	-	-

Intersection						
Int Delay, s/veh	7.8					
Movement	EBL	EBR	NBL	NBT	SBT	SBR
Lane Configurations	W		W	↑	W	
Traffic Vol, veh/h	0	40	31	0	0	0
Future Vol, veh/h	0	40	31	0	0	0
Conflicting Peds, #/hr	0	0	0	0	0	0
Sign Control	Stop	Stop	Free	Free	Free	Free
RT Channelized	-	None	-	None	-	None
Storage Length	0	-	50	-	-	-
Veh in Median Storage, #	0	-	-	0	0	-
Grade, %	0	-	-	0	0	-
Peak Hour Factor	86	86	86	86	86	86
Heavy Vehicles, %	0	0	0	0	0	0
Mvmt Flow	0	47	36	0	0	0

Major/Minor	Minor2	Major1		Major2	
Conflicting Flow All	73	1	1	0	0
Stage 1	1	-	-	-	-
Stage 2	72	-	-	-	-
Critical Hdwy	6.4	6.2	4.1	-	-
Critical Hdwy Stg 1	5.4	-	-	-	-
Critical Hdwy Stg 2	5.4	-	-	-	-
Follow-up Hdwy	3.5	3.3	2.2	-	-
Pot Cap-1 Maneuver	936	1089	1635	-	-
Stage 1	1027	-	-	-	-
Stage 2	956	-	-	-	-
Platoon blocked, %				-	-
Mov Cap-1 Maneuver	915	1089	1635	-	-
Mov Cap-2 Maneuver	861	-	-	-	-
Stage 1	1005	-	-	-	-
Stage 2	956	-	-	-	-

Approach	EB	NB	SB
HCM Ctrl Dly, s/v	8.45	7.25	0
HCM LOS	A		

Minor Lane/Major Mvmt	NBL	NBT	EBLn1	SBT	SBR
Capacity (veh/h)	1635	-	1089	-	-
HCM Lane V/C Ratio	0.022	-	0.043	-	-
HCM Ctrl Dly (s/v)	7.3	-	8.5	-	-
HCM Lane LOS	A	-	A	-	-
HCM 95th %tile Q(veh)	0.1	-	0.1	-	-

Intersection												
Int Delay, s/veh	7											
Movement	EBL	EBT	EBR	WBL	WBT	WBR	NBL	NBT	NBR	SBL	SBT	SBR
Lane Configurations		+			+		↑	↑		↑	↑	
Traffic Vol, veh/h	36	0	37	10	0	1	11	1	3	0	22	0
Future Vol, veh/h	36	0	37	10	0	1	11	1	3	0	22	0
Conflicting Peds, #/hr	0	0	0	0	0	0	0	0	0	0	0	0
Sign Control	Stop	Stop	Stop	Stop	Stop	Stop	Free	Free	Free	Free	Free	Free
RT Channelized	-	-	None	-	-	None	-	-	None	-	-	None
Storage Length	-	-	-	-	-	-	50	-	-	50	-	-
Veh in Median Storage, #	-	0	-	-	0	-	-	0	-	-	0	-
Grade, %	-	0	-	-	0	-	-	0	-	-	0	-
Peak Hour Factor	67	92	67	92	92	92	67	67	92	92	67	67
Heavy Vehicles, %	3	2	3	2	2	2	9	9	2	2	0	0
Mvmt Flow	54	0	55	11	0	1	16	1	3	0	33	0

Major/Minor	Minor2		Minor1		Major1			Major2				
Conflicting Flow All	67	70	33	69	69	3	33	0	0	5	0	0
Stage 1	33	33	-	36	36	-	-	-	-	-	-	-
Stage 2	34	38	-	33	33	-	-	-	-	-	-	-
Critical Hdwy	7.13	6.52	6.23	7.12	6.52	6.22	4.19	-	-	4.12	-	-
Critical Hdwy Stg 1	6.13	5.52	-	6.12	5.52	-	-	-	-	-	-	-
Critical Hdwy Stg 2	6.13	5.52	-	6.12	5.52	-	-	-	-	-	-	-
Follow-up Hdwy	3.527	4.018	3.327	3.518	4.018	3.318	2.281	-	-	2.218	-	-
Pot Cap-1 Maneuver	923	820	1038	923	822	1081	1535	-	-	1617	-	-
Stage 1	981	868	-	980	865	-	-	-	-	-	-	-
Stage 2	979	864	-	983	868	-	-	-	-	-	-	-
Platoon blocked, %								-	-	-	-	-
Mov Cap-1 Maneuver	912	811	1038	865	813	1081	1535	-	-	1617	-	-
Mov Cap-2 Maneuver	912	811	-	865	813	-	-	-	-	-	-	-
Stage 1	981	868	-	969	856	-	-	-	-	-	-	-
Stage 2	968	854	-	931	868	-	-	-	-	-	-	-

Approach	EB		WB		NB		SB	
HCM Ctrl Dly, s/v	9.17		9.14		5.72		0	
HCM LOS	A		A					

Minor Lane/Major Mvmt	NBL	NBT	NBR	EBLn1WBLn1	SBL	SBT	SBR
Capacity (veh/h)	1535	-	-	972	881	1617	-
HCM Lane V/C Ratio	0.011	-	-	0.112	0.014	-	-
HCM Ctrl Dly (s/v)	7.4	-	-	9.2	9.1	0	-
HCM Lane LOS	A	-	-	A	A	A	-
HCM 95th %tile Q(veh)	0	-	-	0.4	0	0	-

Intersection												
Int Delay, s/veh	6.2											
Movement	EBL	EBT	EBR	WBL	WBT	WBR	NBL	NBT	NBR	SBL	SBT	SBR
Lane Configurations		+			+		↑	↑		↑	↑	
Traffic Vol, veh/h	0	0	40	6	0	1	31	3	10	1	11	0
Future Vol, veh/h	0	0	40	6	0	1	31	3	10	1	11	0
Conflicting Peds, #/hr	0	0	0	0	0	0	0	0	0	0	0	0
Sign Control	Stop	Stop	Stop	Stop	Stop	Stop	Free	Free	Free	Free	Free	Free
RT Channelized	-	-	None	-	-	None	-	-	None	-	-	None
Storage Length	-	-	-	-	-	-	50	-	-	50	-	-
Veh in Median Storage, #	-	0	-	-	0	-	-	0	-	-	0	-
Grade, %	-	0	-	-	0	-	-	0	-	-	0	-
Peak Hour Factor	86	92	86	92	92	92	86	86	92	92	86	86
Heavy Vehicles, %	0	2	0	2	2	2	0	0	2	2	0	0
Mvmt Flow	0	0	47	7	0	1	36	3	11	1	13	0

Major/Minor	Minor2		Minor1		Major1		Major2					
Conflicting Flow All	91	101	13	96	96	9	13	0	0	14	0	0
Stage 1	15	15	-	81	81	-	-	-	-	-	-	-
Stage 2	76	86	-	15	15	-	-	-	-	-	-	-
Critical Hdwy	7.1	6.52	6.2	7.12	6.52	6.22	4.1	-	-	4.12	-	-
Critical Hdwy Stg 1	6.1	5.52	-	6.12	5.52	-	-	-	-	-	-	-
Critical Hdwy Stg 2	6.1	5.52	-	6.12	5.52	-	-	-	-	-	-	-
Follow-up Hdwy	3.5	4.018	3.3	3.518	4.018	3.318	2.2	-	-	2.218	-	-
Pot Cap-1 Maneuver	899	789	1073	887	794	1073	1619	-	-	1604	-	-
Stage 1	1010	883	-	927	828	-	-	-	-	-	-	-
Stage 2	939	823	-	1005	883	-	-	-	-	-	-	-
Platoon blocked, %								-	-	-	-	-
Mov Cap-1 Maneuver	877	771	1073	829	776	1073	1619	-	-	1604	-	-
Mov Cap-2 Maneuver	877	771	-	829	776	-	-	-	-	-	-	-
Stage 1	1009	882	-	907	809	-	-	-	-	-	-	-
Stage 2	917	805	-	961	882	-	-	-	-	-	-	-

Approach	EB		WB		NB		SB	
HCM Ctrl Dly, s/v	8.51		9.24		5.2		0.57	
HCM LOS	A		A					

Minor Lane/Major Mvmt	NBL	NBT	NBR	EBLn1WBLn1	SBL	SBT	SBR
Capacity (veh/h)	1619	-	-	1073	857	1604	-
HCM Lane V/C Ratio	0.022	-	-	0.043	0.009	0.001	-
HCM Ctrl Dly (s/v)	7.3	-	-	8.5	9.2	7.2	-
HCM Lane LOS	A	-	-	A	A	A	-
HCM 95th %tile Q(veh)	0.1	-	-	0.1	0	0	-

Intersection						
Int Delay, s/veh	7.7					
Movement	EBL	EBR	NBL	NBT	SBT	SBR
Lane Configurations	W		W	↑	W	
Traffic Vol, veh/h	5	44	13	0	6	0
Future Vol, veh/h	5	44	13	0	6	0
Conflicting Peds, #/hr	0	0	0	0	0	0
Sign Control	Stop	Stop	Free	Free	Free	Free
RT Channelized	-	None	-	None	-	None
Storage Length	0	-	50	-	-	-
Veh in Median Storage, #	0	-	-	0	0	-
Grade, %	0	-	-	0	0	-
Peak Hour Factor	67	67	67	67	67	67
Heavy Vehicles, %	3	3	9	9	0	0
Mvmt Flow	7	66	19	0	9	0

Major/Minor	Minor2	Major1	Major2			
Conflicting Flow All	48	9	9	0	-	0
Stage 1	9	-	-	-	-	-
Stage 2	39	-	-	-	-	-
Critical Hdwy	6.43	6.23	4.19	-	-	-
Critical Hdwy Stg 1	5.43	-	-	-	-	-
Critical Hdwy Stg 2	5.43	-	-	-	-	-
Follow-up Hdwy	3.527	3.327	2.281	-	-	-
Pot Cap-1 Maneuver	959	1070	1566	-	-	-
Stage 1	1011	-	-	-	-	-
Stage 2	981	-	-	-	-	-
Platoon blocked, %				-	-	-
Mov Cap-1 Maneuver	947	1070	1566	-	-	-
Mov Cap-2 Maneuver	883	-	-	-	-	-
Stage 1	999	-	-	-	-	-
Stage 2	981	-	-	-	-	-

Approach	EB	NB	SB
HCM Ctrl Dly, s/v	8.7	7.33	0
HCM LOS	A		

Minor Lane/Major Mvmt	NBL	NBT	EBLn1	SBT	SBR
Capacity (veh/h)	1566	-	1047	-	-
HCM Lane V/C Ratio	0.012	-	0.07	-	-
HCM Ctrl Dly (s/v)	7.3	-	8.7	-	-
HCM Lane LOS	A	-	A	-	-
HCM 95th %tile Q(veh)	0	-	0.2	-	-

Intersection						
Int Delay, s/veh	7.9					
Movement	EBL	EBR	NBL	NBT	SBT	SBR
Lane Configurations	W		W	↑	W	
Traffic Vol, veh/h	0	48	37	0	0	0
Future Vol, veh/h	0	48	37	0	0	0
Conflicting Peds, #/hr	0	0	0	0	0	0
Sign Control	Stop	Stop	Free	Free	Free	Free
RT Channelized	-	None	-	None	-	None
Storage Length	0	-	50	-	-	-
Veh in Median Storage, #	0	-	-	0	0	-
Grade, %	0	-	-	0	0	-
Peak Hour Factor	86	86	86	86	86	86
Heavy Vehicles, %	0	0	0	0	0	0
Mvmt Flow	0	56	43	0	0	0

Major/Minor	Minor2	Major1		Major2	
Conflicting Flow All	87	1	1	0	0
Stage 1	1	-	-	-	-
Stage 2	86	-	-	-	-
Critical Hdwy	6.4	6.2	4.1	-	-
Critical Hdwy Stg 1	5.4	-	-	-	-
Critical Hdwy Stg 2	5.4	-	-	-	-
Follow-up Hdwy	3.5	3.3	2.2	-	-
Pot Cap-1 Maneuver	919	1089	1635	-	-
Stage 1	1027	-	-	-	-
Stage 2	942	-	-	-	-
Platoon blocked, %				-	-
Mov Cap-1 Maneuver	895	1089	1635	-	-
Mov Cap-2 Maneuver	847	-	-	-	-
Stage 1	1000	-	-	-	-
Stage 2	942	-	-	-	-

Approach	EB	NB	SB
HCM Ctrl Dly, s/v	8.48	7.26	0
HCM LOS	A		

Minor Lane/Major Mvmt	NBL	NBT	EBLn1	SBT	SBR
Capacity (veh/h)	1635	-	1089	-	-
HCM Lane V/C Ratio	0.026	-	0.051	-	-
HCM Ctrl Dly (s/v)	7.3	-	8.5	-	-
HCM Lane LOS	A	-	A	-	-
HCM 95th %tile Q(veh)	0.1	-	0.2	-	-

Intersection												
Int Delay, s/veh	7.3											
Movement	EBL	EBT	EBR	WBL	WBT	WBR	NBL	NBT	NBR	SBL	SBT	SBR
Lane Configurations		+			+		↑	↑		↑	↑	
Traffic Vol, veh/h	43	0	44	10	0	1	13	1	3	0	23	0
Future Vol, veh/h	43	0	44	10	0	1	13	1	3	0	23	0
Conflicting Peds, #/hr	0	0	0	0	0	0	0	0	0	0	0	0
Sign Control	Stop	Stop	Stop	Stop	Stop	Stop	Free	Free	Free	Free	Free	Free
RT Channelized	-	-	None	-	-	None	-	-	None	-	-	None
Storage Length	-	-	-	-	-	-	50	-	-	50	-	-
Veh in Median Storage, #	-	0	-	-	0	-	-	0	-	-	0	-
Grade, %	-	0	-	-	0	-	-	0	-	-	0	-
Peak Hour Factor	67	92	67	92	92	92	67	67	92	92	67	67
Heavy Vehicles, %	3	2	3	2	2	2	9	9	2	2	0	0
Mvmt Flow	64	0	66	11	0	1	19	1	3	0	34	0

Major/Minor	Minor2		Minor1		Major1			Major2				
Conflicting Flow All	75	78	34	76	76	3	34	0	0	5	0	0
Stage 1	34	34	-	42	42	-	-	-	-	-	-	-
Stage 2	40	44	-	34	34	-	-	-	-	-	-	-
Critical Hdwy	7.13	6.52	6.23	7.12	6.52	6.22	4.19	-	-	4.12	-	-
Critical Hdwy Stg 1	6.13	5.52	-	6.12	5.52	-	-	-	-	-	-	-
Critical Hdwy Stg 2	6.13	5.52	-	6.12	5.52	-	-	-	-	-	-	-
Follow-up Hdwy	3.527	4.018	3.327	3.518	4.018	3.318	2.281	-	-	2.218	-	-
Pot Cap-1 Maneuver	913	812	1036	913	814	1081	1533	-	-	1617	-	-
Stage 1	979	866	-	973	860	-	-	-	-	-	-	-
Stage 2	972	859	-	982	866	-	-	-	-	-	-	-
Platoon blocked, %								-	-	-	-	-
Mov Cap-1 Maneuver	901	802	1036	845	804	1081	1533	-	-	1617	-	-
Mov Cap-2 Maneuver	901	802	-	845	804	-	-	-	-	-	-	-
Stage 1	979	866	-	960	849	-	-	-	-	-	-	-
Stage 2	959	848	-	919	866	-	-	-	-	-	-	-

Approach	EB		WB		NB		SB	
HCM Ctrl Dly, s/v	9.31		9.24		5.93		0	
HCM LOS	A		A					

Minor Lane/Major Mvmt	NBL	NBT	NBR	EBLn1WBLn1	SBL	SBT	SBR
Capacity (veh/h)	1533	-	-	964	862	1617	-
HCM Lane V/C Ratio	0.013	-	-	0.135	0.014	-	-
HCM Ctrl Dly (s/v)	7.4	-	-	9.3	9.2	0	-
HCM Lane LOS	A	-	-	A	A	A	-
HCM 95th %tile Q(veh)	0	-	-	0.5	0	0	-

Intersection												
Int Delay, s/veh	6.5											
Movement	EBL	EBT	EBR	WBL	WBT	WBR	NBL	NBT	NBR	SBL	SBT	SBR
Lane Configurations		+			+		↑	↑		↑	↑	
Traffic Vol, veh/h	0	0	48	6	0	1	37	3	10	1	11	0
Future Vol, veh/h	0	0	48	6	0	1	37	3	10	1	11	0
Conflicting Peds, #/hr	0	0	0	0	0	0	0	0	0	0	0	0
Sign Control	Stop	Stop	Stop	Stop	Stop	Stop	Free	Free	Free	Free	Free	Free
RT Channelized	-	-	None	-	-	None	-	-	None	-	-	None
Storage Length	-	-	-	-	-	-	50	-	-	50	-	-
Veh in Median Storage, #	-	0	-	-	0	-	-	0	-	-	0	-
Grade, %	-	0	-	-	0	-	-	0	-	-	0	-
Peak Hour Factor	86	92	86	92	92	92	86	86	92	92	86	86
Heavy Vehicles, %	0	2	0	2	2	2	0	0	2	2	0	0
Mvmt Flow	0	0	56	7	0	1	43	3	11	1	13	0

Major/Minor	Minor2		Minor1		Major1		Major2					
Conflicting Flow All	104	115	13	110	110	9	13	0	0	14	0	0
Stage 1	15	15	-	95	95	-	-	-	-	-	-	-
Stage 2	90	100	-	15	15	-	-	-	-	-	-	-
Critical Hdwy	7.1	6.52	6.2	7.12	6.52	6.22	4.1	-	-	4.12	-	-
Critical Hdwy Stg 1	6.1	5.52	-	6.12	5.52	-	-	-	-	-	-	-
Critical Hdwy Stg 2	6.1	5.52	-	6.12	5.52	-	-	-	-	-	-	-
Follow-up Hdwy	3.5	4.018	3.3	3.518	4.018	3.318	2.2	-	-	2.218	-	-
Pot Cap-1 Maneuver	880	775	1073	868	780	1073	1619	-	-	1604	-	-
Stage 1	1010	883	-	912	816	-	-	-	-	-	-	-
Stage 2	923	812	-	1005	883	-	-	-	-	-	-	-
Platoon blocked, %								-	-	-	-	-
Mov Cap-1 Maneuver	855	754	1073	801	759	1073	1619	-	-	1604	-	-
Mov Cap-2 Maneuver	855	754	-	801	759	-	-	-	-	-	-	-
Stage 1	1009	882	-	888	795	-	-	-	-	-	-	-
Stage 2	897	790	-	952	882	-	-	-	-	-	-	-

Approach	EB		WB		NB		SB	
HCM Ctrl Dly, s/v	8.54		9.37		5.46		0.57	
HCM LOS	A		A					

Minor Lane/Major Mvmt	NBL	NBT	NBR	EBLn1WBLn1	SBL	SBT	SBR
Capacity (veh/h)	1619	-	-	1073	831	1604	-
HCM Lane V/C Ratio	0.027	-	-	0.052	0.009	0.001	-
HCM Ctrl Dly (s/v)	7.3	-	-	8.5	9.4	7.2	-
HCM Lane LOS	A	-	-	A	A	A	-
HCM 95th %tile Q(veh)	0.1	-	-	0.2	0	0	-

Intersection												
Int Delay, s/veh	1.3											
Movement	EBL	EBT	EBR	WBL	WBT	WBR	NBL	NBT	NBR	SBL	SBT	SBR
Lane Configurations	↗	↗↘		↗	↗↘			↘		↗	↘	
Traffic Vol, veh/h	7	533	10	21	593	3	14	0	53	3	0	0
Future Vol, veh/h	7	533	10	21	593	3	14	0	53	3	0	0
Conflicting Peds, #/hr	0	0	0	0	0	0	0	0	0	0	0	0
Sign Control	Free	Free	Free	Free	Free	Free	Stop	Stop	Stop	Stop	Stop	Stop
RT Channelized	-	-	None	-	-	None	-	-	None	-	-	None
Storage Length	200	-	-	150	-	-	-	-	-	250	-	-
Veh in Median Storage, #	-	0	-	-	0	-	-	1	-	-	1	-
Grade, %	-	0	-	-	0	-	-	0	-	-	0	-
Peak Hour Factor	59	59	59	59	59	59	59	59	59	59	59	59
Heavy Vehicles, %	1	1	1	1	1	1	0	0	0	0	0	0
Mvmt Flow	12	903	17	36	1005	5	24	0	90	5	0	0

Major/Minor	Major1			Major2			Minor1			Minor2		
Conflicting Flow All	1010	0	0	920	0	0	1509	2017	460	1554	2023	505
Stage 1	-	-	-	-	-	-	936	936	-	1079	1079	-
Stage 2	-	-	-	-	-	-	574	1081	-	475	944	-
Critical Hdwy	4.12	-	-	4.12	-	-	7.5	6.5	6.9	7.5	6.5	6.9
Critical Hdwy Stg 1	-	-	-	-	-	-	6.5	5.5	-	6.5	5.5	-
Critical Hdwy Stg 2	-	-	-	-	-	-	6.5	5.5	-	6.5	5.5	-
Follow-up Hdwy	2.21	-	-	2.21	-	-	3.5	4	3.3	3.5	4	3.3
Pot Cap-1 Maneuver	688	-	-	744	-	-	85	59	554	78	59	518
Stage 1	-	-	-	-	-	-	289	347	-	237	297	-
Stage 2	-	-	-	-	-	-	476	296	-	544	343	-
Platoon blocked, %	-	-	-	-	-	-	-	-	-	-	-	-
Mov Cap-1 Maneuver	688	-	-	744	-	-	79	55	554	61	55	518
Mov Cap-2 Maneuver	-	-	-	-	-	-	192	162	-	158	158	-
Stage 1	-	-	-	-	-	-	284	341	-	225	283	-
Stage 2	-	-	-	-	-	-	453	282	-	448	338	-

Approach	EB			WB			NB			SB		
HCM Ctrl Dly, s/v	0.13			0.34			17.66			28.53		
HCM LOS							C			D		

Minor Lane/Major Mvmt	NBLn1	EBL	EBT	EBR	WBL	WBT	WBR	SBLn1	SBLn2
Capacity (veh/h)	397	688	-	-	744	-	-	158	-
HCM Lane V/C Ratio	0.286	0.017	-	-	0.048	-	-	0.032	-
HCM Ctrl Dly (s/v)	17.7	10.3	-	-	10.1	-	-	28.5	0
HCM Lane LOS	C	B	-	-	B	-	-	D	A
HCM 95th %tile Q(veh)	1.2	0.1	-	-	0.2	-	-	0.1	-

Intersection												
Int Delay, s/veh	1.3											
Movement	EBL	EBT	EBR	WBL	WBT	WBR	NBL	NBT	NBR	SBL	SBT	SBR
Lane Configurations	↖	↗		↖	↗			↕		↖	↗	
Traffic Vol, veh/h	0	270	9	39	211	1	5	0	35	2	0	1
Future Vol, veh/h	0	270	9	39	211	1	5	0	35	2	0	1
Conflicting Peds, #/hr	0	0	0	0	0	0	0	0	0	0	0	0
Sign Control	Free	Free	Free	Free	Free	Free	Stop	Stop	Stop	Stop	Stop	Stop
RT Channelized	-	-	None	-	-	None	-	-	None	-	-	None
Storage Length	200	-	-	150	-	-	-	-	-	250	-	-
Veh in Median Storage, #	-	0	-	-	0	-	-	1	-	-	1	-
Grade, %	-	0	-	-	0	-	-	0	-	-	0	-
Peak Hour Factor	86	86	86	86	86	86	86	86	86	86	86	86
Heavy Vehicles, %	0	0	0	0	0	0	0	0	0	0	0	0
Mvmt Flow	0	314	10	45	245	1	6	0	41	2	0	1

Major/Minor	Major1			Major2			Minor1			Minor2		
Conflicting Flow All	247	0	0	324	0	0	533	656	162	494	661	123
Stage 1	-	-	-	-	-	-	319	319	-	337	337	-
Stage 2	-	-	-	-	-	-	213	337	-	157	324	-
Critical Hdwy	4.1	-	-	4.1	-	-	7.5	6.5	6.9	7.5	6.5	6.9
Critical Hdwy Stg 1	-	-	-	-	-	-	6.5	5.5	-	6.5	5.5	-
Critical Hdwy Stg 2	-	-	-	-	-	-	6.5	5.5	-	6.5	5.5	-
Follow-up Hdwy	2.2	-	-	2.2	-	-	3.5	4	3.3	3.5	4	3.3
Pot Cap-1 Maneuver	1331	-	-	1247	-	-	434	388	860	463	385	911
Stage 1	-	-	-	-	-	-	672	656	-	657	645	-
Stage 2	-	-	-	-	-	-	775	645	-	835	653	-
Platoon blocked, %		-	-		-	-						
Mov Cap-1 Maneuver	1331	-	-	1247	-	-	418	373	860	425	371	911
Mov Cap-2 Maneuver	-	-	-	-	-	-	512	461	-	504	450	-
Stage 1	-	-	-	-	-	-	672	656	-	633	622	-
Stage 2	-	-	-	-	-	-	746	621	-	796	653	-

Approach	EB			WB			NB			SB		
HCM Ctrl Dly, s/v	0			1.24			9.82			11.11		
HCM LOS							A			B		

Minor Lane/Major Mvmt	NBLn1	EBL	EBT	EBR	WBL	WBT	WBR	SBLn1	SBLn2
Capacity (veh/h)	793	1331	-	-	1247	-	-	504	911
HCM Lane V/C Ratio	0.059	-	-	-	0.036	-	-	0.005	0.001
HCM Ctrl Dly (s/v)	9.8	0	-	-	8	-	-	12.2	9
HCM Lane LOS	A	A	-	-	A	-	-	B	A
HCM 95th %tile Q(veh)	0.2	0	-	-	0.1	-	-	0	0

Intersection												
Int Delay, s/veh	1.3											
Movement	EBL	EBT	EBR	WBL	WBT	WBR	NBL	NBT	NBR	SBL	SBT	SBR
Lane Configurations	↖	↖↗		↖	↖↗			↖↗		↖	↗	
Traffic Vol, veh/h	7	596	10	22	625	3	14	0	55	3	0	0
Future Vol, veh/h	7	596	10	22	625	3	14	0	55	3	0	0
Conflicting Peds, #/hr	0	0	0	0	0	0	0	0	0	0	0	0
Sign Control	Free	Free	Free	Free	Free	Free	Stop	Stop	Stop	Stop	Stop	Stop
RT Channelized	-	-	None	-	-	None	-	-	None	-	-	None
Storage Length	200	-	-	150	-	-	-	-	-	250	-	-
Veh in Median Storage, #	-	0	-	-	0	-	-	1	-	-	1	-
Grade, %	-	0	-	-	0	-	-	0	-	-	0	-
Peak Hour Factor	59	59	59	59	59	59	59	59	59	59	59	59
Heavy Vehicles, %	1	1	1	1	1	1	0	0	0	0	0	0
Mvmt Flow	12	1010	17	37	1059	5	24	0	93	5	0	0

Major/Minor	Major1			Major2			Minor1			Minor2		
Conflicting Flow All	1064	0	0	1027	0	0	1647	2181	514	1665	2187	532
Stage 1	-	-	-	-	-	-	1042	1042	-	1136	1136	-
Stage 2	-	-	-	-	-	-	604	1139	-	529	1051	-
Critical Hdwy	4.12	-	-	4.12	-	-	7.5	6.5	6.9	7.5	6.5	6.9
Critical Hdwy Stg 1	-	-	-	-	-	-	6.5	5.5	-	6.5	5.5	-
Critical Hdwy Stg 2	-	-	-	-	-	-	6.5	5.5	-	6.5	5.5	-
Follow-up Hdwy	2.21	-	-	2.21	-	-	3.5	4	3.3	3.5	4	3.3
Pot Cap-1 Maneuver	656	-	-	678	-	-	67	47	511	65	46	497
Stage 1	-	-	-	-	-	-	249	309	-	218	279	-
Stage 2	-	-	-	-	-	-	457	278	-	506	306	-
Platoon blocked, %	-	-	-	-	-	-	-	-	-	-	-	-
Mov Cap-1 Maneuver	656	-	-	678	-	-	62	43	511	49	43	497
Mov Cap-2 Maneuver	-	-	-	-	-	-	167	145	-	141	140	-
Stage 1	-	-	-	-	-	-	245	304	-	206	264	-
Stage 2	-	-	-	-	-	-	432	263	-	407	301	-

Approach	EB			WB			NB			SB		
HCM Ctrl Dly, s/v	0.12			0.36			19.71			31.48		
HCM LOS							C			D		

Minor Lane/Major Mvmt	NBLn1	EBL	EBT	EBR	WBL	WBT	WBR	SBLn1	SBLn2
Capacity (veh/h)	360	656	-	-	678	-	-	141	-
HCM Lane V/C Ratio	0.325	0.018	-	-	0.055	-	-	0.036	-
HCM Ctrl Dly (s/v)	19.7	10.6	-	-	10.6	-	-	31.5	0
HCM Lane LOS	C	B	-	-	B	-	-	D	A
HCM 95th %tile Q(veh)	1.4	0.1	-	-	0.2	-	-	0.1	-

Intersection												
Int Delay, s/veh	1.2											
Movement	EBL	EBT	EBR	WBL	WBT	WBR	NBL	NBT	NBR	SBL	SBT	SBR
Lane Configurations	↖	↖↗		↖	↖↗			↖↗		↖	↗	
Traffic Vol, veh/h	0	302	9	40	254	1	5	0	36	2	0	1
Future Vol, veh/h	0	302	9	40	254	1	5	0	36	2	0	1
Conflicting Peds, #/hr	0	0	0	0	0	0	0	0	0	0	0	0
Sign Control	Free	Free	Free	Free	Free	Free	Stop	Stop	Stop	Stop	Stop	Stop
RT Channelized	-	-	None	-	-	None	-	-	None	-	-	None
Storage Length	200	-	-	150	-	-	-	-	-	250	-	-
Veh in Median Storage, #	-	0	-	-	0	-	-	1	-	-	1	-
Grade, %	-	0	-	-	0	-	-	0	-	-	0	-
Peak Hour Factor	86	86	86	86	86	86	86	86	86	86	86	86
Heavy Vehicles, %	0	0	0	0	0	0	0	0	0	0	0	0
Mvmt Flow	0	351	10	47	295	1	6	0	42	2	0	1

Major/Minor	Major1			Major2			Minor1			Minor2		
Conflicting Flow All	297	0	0	362	0	0	597	746	181	565	751	148
Stage 1	-	-	-	-	-	-	356	356	-	389	389	-
Stage 2	-	-	-	-	-	-	241	390	-	176	362	-
Critical Hdwy	4.1	-	-	4.1	-	-	7.5	6.5	6.9	7.5	6.5	6.9
Critical Hdwy Stg 1	-	-	-	-	-	-	6.5	5.5	-	6.5	5.5	-
Critical Hdwy Stg 2	-	-	-	-	-	-	6.5	5.5	-	6.5	5.5	-
Follow-up Hdwy	2.2	-	-	2.2	-	-	3.5	4	3.3	3.5	4	3.3
Pot Cap-1 Maneuver	1276	-	-	1208	-	-	391	344	837	412	342	878
Stage 1	-	-	-	-	-	-	639	632	-	612	612	-
Stage 2	-	-	-	-	-	-	747	611	-	815	629	-
Platoon blocked, %		-	-		-	-						
Mov Cap-1 Maneuver	1276	-	-	1208	-	-	375	331	837	377	329	878
Mov Cap-2 Maneuver	-	-	-	-	-	-	479	429	-	464	417	-
Stage 1	-	-	-	-	-	-	639	632	-	588	588	-
Stage 2	-	-	-	-	-	-	717	588	-	774	629	-

Approach	EB			WB			NB			SB		
HCM Ctrl Dly, s/v	0			1.1			10			11.56		
HCM LOS							B			B		

Minor Lane/Major Mvmt	NBLn1	EBL	EBT	EBR	WBL	WBT	WBR	SBLn1	SBLn2
Capacity (veh/h)	767	1276	-	-	1208	-	-	464	878
HCM Lane V/C Ratio	0.062	-	-	-	0.038	-	-	0.005	0.001
HCM Ctrl Dly (s/v)	10	0	-	-	8.1	-	-	12.8	9.1
HCM Lane LOS	B	A	-	-	A	-	-	B	A
HCM 95th %tile Q(veh)	0.2	0	-	-	0.1	-	-	0	0

Intersection												
Int Delay, s/veh	16											
Movement	EBL	EBT	EBR	WBL	WBT	WBR	NBL	NBT	NBR	SBL	SBT	SBR
Lane Configurations	↗	↗↘		↗	↗↘			↘		↗	↘	
Traffic Vol, veh/h	16	596	10	22	626	24	14	0	55	98	0	11
Future Vol, veh/h	16	596	10	22	626	24	14	0	55	98	0	11
Conflicting Peds, #/hr	0	0	0	0	0	0	0	0	0	0	0	0
Sign Control	Free	Free	Free	Free	Free	Free	Stop	Stop	Stop	Stop	Stop	Stop
RT Channelized	-	-	None	-	-	None	-	-	None	-	-	None
Storage Length	200	-	-	150	-	-	-	-	-	250	-	-
Veh in Median Storage, #	-	0	-	-	0	-	-	1	-	-	1	-
Grade, %	-	0	-	-	0	-	-	0	-	-	0	-
Peak Hour Factor	59	59	59	59	59	59	59	59	59	59	59	59
Heavy Vehicles, %	1	1	1	1	1	1	0	0	0	0	0	0
Mvmt Flow	27	1010	17	37	1061	41	24	0	93	166	0	19

Major/Minor	Major1			Major2			Minor1			Minor2		
Conflicting Flow All	1102	0	0	1027	0	0	1678	2249	514	1715	2237	551
Stage 1	-	-	-	-	-	-	1073	1073	-	1156	1156	-
Stage 2	-	-	-	-	-	-	605	1176	-	559	1081	-
Critical Hdwy	4.12	-	-	4.12	-	-	7.5	6.5	6.9	7.5	6.5	6.9
Critical Hdwy Stg 1	-	-	-	-	-	-	6.5	5.5	-	6.5	5.5	-
Critical Hdwy Stg 2	-	-	-	-	-	-	6.5	5.5	-	6.5	5.5	-
Follow-up Hdwy	2.21	-	-	2.21	-	-	3.5	4	3.3	3.5	4	3.3
Pot Cap-1 Maneuver	635	-	-	678	-	-	63	42	511	~ 59	43	483
Stage 1	-	-	-	-	-	-	239	299	-	212	273	-
Stage 2	-	-	-	-	-	-	456	267	-	486	296	-
Platoon blocked, %	-	-	-	-	-	-	-	-	-	-	-	-
Mov Cap-1 Maneuver	635	-	-	678	-	-	55	38	511	~ 44	39	483
Mov Cap-2 Maneuver	-	-	-	-	-	-	154	132	-	~ 134	133	-
Stage 1	-	-	-	-	-	-	229	286	-	201	258	-
Stage 2	-	-	-	-	-	-	415	253	-	380	284	-

Approach	EB	WB	NB	SB
HCM Ctrl Dly, s/v	0.28	0.35	20.5	198.76
HCM LOS			C	F

Minor Lane/Major Mvmt	NBLn1	EBL	EBT	EBR	WBL	WBT	WBR	SBLn1	SBLn2
Capacity (veh/h)	348	635	-	-	678	-	-	134	483
HCM Lane V/C Ratio	0.336	0.043	-	-	0.055	-	-	1.24	0.039
HCM Ctrl Dly (s/v)	20.5	10.9	-	-	10.6	-	-	219.6	12.7
HCM Lane LOS	C	B	-	-	B	-	-	F	B
HCM 95th %tile Q(veh)	1.4	0.1	-	-	0.2	-	-	10.2	0.1

Notes  
 -: Volume exceeds capacity     \$: Delay exceeds 300s  
 +: Computation Not Defined     \*: All major volume in platoon

Intersection												
Int Delay, s/veh	2.2											
Movement	EBL	EBT	EBR	WBL	WBT	WBR	NBL	NBT	NBR	SBL	SBT	SBR
Lane Configurations	↗	↗↘		↗	↗↘			↘		↗	↘	
Traffic Vol, veh/h	28	302	9	40	257	67	5	0	36	46	0	8
Future Vol, veh/h	28	302	9	40	257	67	5	0	36	46	0	8
Conflicting Peds, #/hr	0	0	0	0	0	0	0	0	0	0	0	0
Sign Control	Free	Free	Free	Free	Free	Free	Stop	Stop	Stop	Stop	Stop	Stop
RT Channelized	-	-	None	-	-	None	-	-	None	-	-	None
Storage Length	200	-	-	150	-	-	-	-	-	250	-	-
Veh in Median Storage, #	-	0	-	-	0	-	-	1	-	-	1	-
Grade, %	-	0	-	-	0	-	-	0	-	-	0	-
Peak Hour Factor	86	86	86	86	86	86	86	86	86	86	86	86
Heavy Vehicles, %	0	0	0	0	0	0	0	0	0	0	0	0
Mvmt Flow	33	351	10	47	299	78	6	0	42	53	0	9

Major/Minor	Major1			Major2			Minor1			Minor2		
Conflicting Flow All	377	0	0	362	0	0	664	891	181	672	858	188
Stage 1	-	-	-	-	-	-	422	422	-	431	431	-
Stage 2	-	-	-	-	-	-	242	470	-	241	427	-
Critical Hdwy	4.1	-	-	4.1	-	-	7.5	6.5	6.9	7.5	6.5	6.9
Critical Hdwy Stg 1	-	-	-	-	-	-	6.5	5.5	-	6.5	5.5	-
Critical Hdwy Stg 2	-	-	-	-	-	-	6.5	5.5	-	6.5	5.5	-
Follow-up Hdwy	2.2	-	-	2.2	-	-	3.5	4	3.3	3.5	4	3.3
Pot Cap-1 Maneuver	1193	-	-	1208	-	-	350	284	837	346	297	828
Stage 1	-	-	-	-	-	-	586	592	-	578	586	-
Stage 2	-	-	-	-	-	-	745	564	-	747	589	-
Platoon blocked, %	-	-	-	-	-	-	-	-	-	-	-	-
Mov Cap-1 Maneuver	1193	-	-	1208	-	-	324	265	837	307	278	828
Mov Cap-2 Maneuver	-	-	-	-	-	-	428	367	-	411	375	-
Stage 1	-	-	-	-	-	-	570	576	-	556	564	-
Stage 2	-	-	-	-	-	-	709	542	-	690	573	-

Approach	EB		WB		NB		SB	
HCM Ctrl Dly, s/v	0.67		0.89		10.13		14.23	
HCM LOS					B		B	

Minor Lane/Major Mvmt	NBLn1	EBL	EBT	EBR	WBL	WBT	WBR	SBLn1	SBLn2
Capacity (veh/h)	750	1193	-	-	1208	-	-	411	828
HCM Lane V/C Ratio	0.064	0.027	-	-	0.038	-	-	0.13	0.011
HCM Ctrl Dly (s/v)	10.1	8.1	-	-	8.1	-	-	15.1	9.4
HCM Lane LOS	B	A	-	-	A	-	-	C	A
HCM 95th %tile Q(veh)	0.2	0.1	-	-	0.1	-	-	0.4	0

Timings  
4: Greensborough Dr/Plaza Cir & Plaza Dr

2028 Total2 AM\_Signalized  
02/05/2026



Lane Group	EBL	EBT	WBL	WBT	NBL	NBT	SBL	SBT
Lane Configurations	↶	↷	↶	↷		↷	↶	↷
Traffic Volume (vph)	16	596	22	626	14	0	98	0
Future Volume (vph)	16	596	22	626	14	0	98	0
Turn Type	pm+pt	NA	pm+pt	NA	Perm	NA	Perm	NA
Protected Phases	5	2	1	6		8		4
Permitted Phases	2		6		8		4	
Detector Phase	5	2	1	6	8	8	4	4
Switch Phase								
Minimum Initial (s)	5.0	5.0	5.0	5.0	5.0	5.0	5.0	5.0
Minimum Split (s)	11.0	24.0	11.0	24.0	24.0	24.0	24.0	24.0
Total Split (s)	11.0	67.0	12.0	68.0	41.0	41.0	41.0	41.0
Total Split (%)	9.2%	55.8%	10.0%	56.7%	34.2%	34.2%	34.2%	34.2%
Yellow Time (s)	4.0	4.0	4.0	4.0	4.0	4.0	4.0	4.0
All-Red Time (s)	2.0	2.0	2.0	2.0	2.0	2.0	2.0	2.0
Lost Time Adjust (s)	0.0	0.0	0.0	0.0		0.0	0.0	0.0
Total Lost Time (s)	6.0	6.0	6.0	6.0		6.0	6.0	6.0
Lead/Lag	Lead	Lag	Lead	Lag				
Lead-Lag Optimize?	Yes	Yes	Yes	Yes				
Recall Mode	None	C-Max	None	C-Max	None	None	None	None

Intersection Summary

Cycle Length: 120  
 Actuated Cycle Length: 120  
 Offset: 0 (0%), Referenced to phase 2:EBTL and 6:WBTL, Start of Green  
 Natural Cycle: 60  
 Control Type: Actuated-Coordinated

Splits and Phases: 4: Greensborough Dr/Plaza Cir & Plaza Dr



HCM 7th Signalized Intersection Summary  
 4: Greensborough Dr/Plaza Cir & Plaza Dr

2028 Total2 AM\_Signalized  
 02/05/2026



Movement	EBL	EBT	EBR	WBL	WBT	WBR	NBL	NBT	NBR	SBL	SBT	SBR
Lane Configurations												
Traffic Volume (veh/h)	16	596	10	22	626	24	14	0	55	98	0	11
Future Volume (veh/h)	16	596	10	22	626	24	14	0	55	98	0	11
Initial Q (Qb), veh	0	0	0	0	0	0	0	0	0	0	0	0
Lane Width Adj.	1.00	1.00	1.00	1.00	1.00	1.00	1.00	1.00	1.00	1.00	1.00	1.00
Ped-Bike Adj(A_pbT)	1.00		1.00	1.00		1.00	1.00		1.00	1.00		1.00
Parking Bus, Adj	1.00	1.00	1.00	1.00	1.00	1.00	1.00	1.00	1.00	1.00	1.00	1.00
Work Zone On Approach		No			No			No			No	
Adj Sat Flow, veh/h/ln	1885	1885	1885	1885	1885	1885	1900	1900	1900	1900	1900	1900
Adj Flow Rate, veh/h	27	1010	17	37	1061	41	24	0	93	166	0	19
Peak Hour Factor	0.59	0.59	0.59	0.59	0.59	0.59	0.59	0.59	0.59	0.59	0.59	0.59
Percent Heavy Veh, %	1	1	1	1	1	1	0	0	0	0	0	0
Cap, veh/h	373	2384	40	406	2342	90	69	20	203	250	0	256
Arrive On Green	0.02	0.66	0.66	0.03	0.67	0.67	0.16	0.00	0.16	0.16	0.00	0.16
Sat Flow, veh/h	1795	3605	61	1795	3516	136	205	123	1272	1324	0	1610
Grp Volume(v), veh/h	27	502	525	37	540	562	117	0	0	166	0	19
Grp Sat Flow(s),veh/h/ln	1795	1791	1874	1795	1791	1861	1601	0	0	1324	0	1610
Q Serve(g_s), s	0.6	15.8	15.8	0.8	17.3	17.3	0.8	0.0	0.0	8.9	0.0	1.2
Cycle Q Clear(g_c), s	0.6	15.8	15.8	0.8	17.3	17.3	7.7	0.0	0.0	16.6	0.0	1.2
Prop In Lane	1.00		0.03	1.00		0.07	0.21		0.79	1.00		1.00
Lane Grp Cap(c), veh/h	373	1184	1239	406	1193	1239	291	0	0	250	0	256
V/C Ratio(X)	0.07	0.42	0.42	0.09	0.45	0.45	0.40	0.00	0.00	0.66	0.00	0.07
Avail Cap(c_a), veh/h	404	1184	1239	443	1193	1239	498	0	0	426	0	470
HCM Platoon Ratio	1.00	1.00	1.00	1.00	1.00	1.00	1.00	1.00	1.00	1.00	1.00	1.00
Upstream Filter(I)	1.00	1.00	1.00	0.77	0.77	0.77	1.00	0.00	0.00	1.00	0.00	1.00
Uniform Delay (d), s/veh	7.2	9.6	9.6	7.0	9.6	9.6	45.6	0.0	0.0	49.9	0.0	42.9
Incr Delay (d2), s/veh	0.1	1.1	1.1	0.1	1.0	0.9	0.9	0.0	0.0	3.0	0.0	0.1
Initial Q Delay(d3), s/veh	0.0	0.0	0.0	0.0	0.0	0.0	0.0	0.0	0.0	0.0	0.0	0.0
%ile BackOfQ(95%),veh/ln	0.4	9.9	10.2	0.5	10.0	10.3	5.9	0.0	0.0	8.8	0.0	0.9
Unsig. Movement Delay, s/veh												
LnGrp Delay(d), s/veh	7.3	10.7	10.6	7.0	10.5	10.5	46.5	0.0	0.0	52.9	0.0	43.0
LnGrp LOS	A	B	B	A	B	B	D			D		D
Approach Vol, veh/h		1054			1139			117				185
Approach Delay, s/veh		10.6			10.4			46.5				51.9
Approach LOS		B			B			D				D
Timer - Assigned Phs	1	2		4	5	6		8				
Phs Duration (G+Y+Rc), s	9.5	85.4		25.1	9.0	85.9		25.1				
Change Period (Y+Rc), s	6.0	6.0		6.0	6.0	6.0		6.0				
Max Green Setting (Gmax), s	6.0	61.0		35.0	5.0	62.0		35.0				
Max Q Clear Time (g_c+I1), s	2.8	17.8		18.6	2.6	19.3		9.7				
Green Ext Time (p_c), s	0.0	7.5		0.5	0.0	8.4		0.7				
<b>Intersection Summary</b>												
HCM 7th Control Delay, s/veh					15.2							
HCM 7th LOS					B							

Timings  
4: Greensborough Dr/Plaza Cir & Plaza Dr

2028 Total2 PM\_Signalized  
02/05/2026



Lane Group	EBL	EBT	WBL	WBT	NBL	NBT	SBL	SBT
Lane Configurations	↶	↷	↶	↷		↷	↶	↷
Traffic Volume (vph)	28	302	40	257	5	0	46	0
Future Volume (vph)	28	302	40	257	5	0	46	0
Turn Type	pm+pt	NA	pm+pt	NA	Perm	NA	Perm	NA
Protected Phases	5	2	1	6		8		4
Permitted Phases	2		6		8		4	
Detector Phase	5	2	1	6	8	8	4	4
Switch Phase								
Minimum Initial (s)	5.0	5.0	5.0	5.0	5.0	5.0	5.0	5.0
Minimum Split (s)	11.0	24.0	11.0	24.0	24.0	24.0	24.0	24.0
Total Split (s)	19.0	55.0	23.0	59.0	42.0	42.0	42.0	42.0
Total Split (%)	15.8%	45.8%	19.2%	49.2%	35.0%	35.0%	35.0%	35.0%
Yellow Time (s)	4.0	4.0	4.0	4.0	4.0	4.0	4.0	4.0
All-Red Time (s)	2.0	2.0	2.0	2.0	2.0	2.0	2.0	2.0
Lost Time Adjust (s)	0.0	0.0	0.0	0.0		0.0	0.0	0.0
Total Lost Time (s)	6.0	6.0	6.0	6.0		6.0	6.0	6.0
Lead/Lag	Lead	Lag	Lead	Lag				
Lead-Lag Optimize?	Yes	Yes	Yes	Yes				
Recall Mode	None	C-Max	None	C-Max	None	None	None	None

Intersection Summary

Cycle Length: 120  
 Actuated Cycle Length: 120  
 Offset: 0 (0%), Referenced to phase 2:EBTL and 6:WBTL, Start of Green  
 Natural Cycle: 60  
 Control Type: Actuated-Coordinated

Splits and Phases: 4: Greensborough Dr/Plaza Cir & Plaza Dr



HCM 7th Signalized Intersection Summary  
 4: Greensborough Dr/Plaza Cir & Plaza Dr

2028 Total2 PM\_Signalized  
 02/05/2026



Movement	EBL	EBT	EBR	WBL	WBT	WBR	NBL	NBT	NBR	SBL	SBT	SBR
Lane Configurations	↗	↗↘		↗	↗↘			↕		↗	↘	
Traffic Volume (veh/h)	28	302	9	40	257	67	5	0	36	46	0	8
Future Volume (veh/h)	28	302	9	40	257	67	5	0	36	46	0	8
Initial Q (Qb), veh	0	0	0	0	0	0	0	0	0	0	0	0
Lane Width Adj.	1.00	1.00	1.00	1.00	1.00	1.00	1.00	1.00	1.00	1.00	1.00	1.00
Ped-Bike Adj(A_pbT)	1.00		1.00	1.00		1.00	1.00		1.00	1.00		1.00
Parking Bus, Adj	1.00	1.00	1.00	1.00	1.00	1.00	1.00	1.00	1.00	1.00	1.00	1.00
Work Zone On Approach		No			No			No			No	
Adj Sat Flow, veh/h/ln	1900	1900	1900	1900	1900	1900	1900	1900	1900	1900	1900	1900
Adj Flow Rate, veh/h	33	351	10	47	299	78	6	0	42	53	0	9
Peak Hour Factor	0.86	0.86	0.86	0.86	0.86	0.86	0.86	0.86	0.86	0.86	0.86	0.86
Percent Heavy Veh, %	0	0	0	0	0	0	0	0	0	0	0	0
Cap, veh/h	875	2762	79	893	2206	566	40	4	65	137	0	75
Arrive On Green	0.03	0.77	0.77	0.03	0.78	0.78	0.05	0.00	0.05	0.05	0.00	0.05
Sat Flow, veh/h	1810	3585	102	1810	2844	730	124	77	1405	1386	0	1610
Grp Volume(v), veh/h	33	176	185	47	188	189	48	0	0	53	0	9
Grp Sat Flow(s),veh/h/ln	1810	1805	1882	1810	1805	1769	1606	0	0	1386	0	1610
Q Serve(g_s), s	0.4	3.0	3.0	0.6	3.1	3.2	1.4	0.0	0.0	0.0	0.0	0.6
Cycle Q Clear(g_c), s	0.4	3.0	3.0	0.6	3.1	3.2	3.5	0.0	0.0	3.5	0.0	0.6
Prop In Lane	1.00		0.05	1.00		0.41	0.12		0.87	1.00		1.00
Lane Grp Cap(c), veh/h	875	1391	1450	893	1400	1372	108	0	0	137	0	75
V/C Ratio(X)	0.04	0.13	0.13	0.05	0.13	0.14	0.44	0.00	0.00	0.39	0.00	0.12
Avail Cap(c_a), veh/h	1021	1391	1450	1089	1400	1372	510	0	0	488	0	483
HCM Platoon Ratio	1.00	1.00	1.00	1.00	1.00	1.00	1.00	1.00	1.00	1.00	1.00	1.00
Upstream Filter(I)	1.00	1.00	1.00	0.88	0.88	0.88	1.00	0.00	0.00	1.00	0.00	1.00
Uniform Delay (d), s/veh	2.5	3.5	3.5	2.4	3.4	3.4	56.2	0.0	0.0	56.2	0.0	54.9
Incr Delay (d2), s/veh	0.0	0.2	0.2	0.0	0.2	0.2	2.8	0.0	0.0	1.8	0.0	0.7
Initial Q Delay(d3), s/veh	0.0	0.0	0.0	0.0	0.0	0.0	0.0	0.0	0.0	0.0	0.0	0.0
%ile BackOfQ(95%),veh/ln	0.2	1.6	1.7	0.3	1.7	1.7	2.7	0.0	0.0	3.0	0.0	0.5
Unsig. Movement Delay, s/veh												
LnGrp Delay(d), s/veh	2.5	3.7	3.7	2.4	3.5	3.6	59.0	0.0	0.0	58.0	0.0	55.6
LnGrp LOS	A	A	A	A	A	A	E			E		E
Approach Vol, veh/h		394			424			48				62
Approach Delay, s/veh		3.6			3.4			59.0				57.6
Approach LOS		A			A			E				E
Timer - Assigned Phs	1	2		4	5	6		8				
Phs Duration (G+Y+Rc), s	10.0	98.5		11.6	9.3	99.1		11.6				
Change Period (Y+Rc), s	6.0	6.0		6.0	6.0	6.0		6.0				
Max Green Setting (Gmax), s	17.0	49.0		36.0	13.0	53.0		36.0				
Max Q Clear Time (g_c+I1), s	2.6	5.0		5.5	2.4	5.2		5.5				
Green Ext Time (p_c), s	0.1	2.1		0.2	0.0	2.2		0.2				
<b>Intersection Summary</b>												
HCM 7th Control Delay, s/veh			10.0									
HCM 7th LOS			A									

Intersection												
Int Delay, s/veh	1.8											
Movement	EBL	EBT	EBR	WBL	WBT	WBR	NBL	NBT	NBR	SBL	SBT	SBR
Lane Configurations	↖	↖↗		↖	↖↗			↕		↖	↗	
Traffic Vol, veh/h	9	697	12	26	738	4	17	0	65	4	0	0
Future Vol, veh/h	9	697	12	26	738	4	17	0	65	4	0	0
Conflicting Peds, #/hr	0	0	0	0	0	0	0	0	0	0	0	0
Sign Control	Free	Free	Free	Free	Free	Free	Stop	Stop	Stop	Stop	Stop	Stop
RT Channelized	-	-	None	-	-	None	-	-	None	-	-	None
Storage Length	200	-	-	150	-	-	-	-	-	250	-	-
Veh in Median Storage, #	-	0	-	-	0	-	-	1	-	-	1	-
Grade, %	-	0	-	-	0	-	-	0	-	-	0	-
Peak Hour Factor	59	59	59	59	59	59	59	59	59	59	59	59
Heavy Vehicles, %	1	1	1	1	1	1	0	0	0	0	0	0
Mvmt Flow	15	1181	20	44	1251	7	29	0	110	7	0	0

Major/Minor	Major1			Major2			Minor1			Minor2		
Conflicting Flow All	1258	0	0	1202	0	0	1936	2568	601	1964	2575	629
Stage 1	-	-	-	-	-	-	1222	1222	-	1342	1342	-
Stage 2	-	-	-	-	-	-	714	1346	-	621	1232	-
Critical Hdwy	4.12	-	-	4.12	-	-	7.5	6.5	6.9	7.5	6.5	6.9
Critical Hdwy Stg 1	-	-	-	-	-	-	6.5	5.5	-	6.5	5.5	-
Critical Hdwy Stg 2	-	-	-	-	-	-	6.5	5.5	-	6.5	5.5	-
Follow-up Hdwy	2.21	-	-	2.21	-	-	3.5	4	3.3	3.5	4	3.3
Pot Cap-1 Maneuver	554	-	-	582	-	-	40	26	449	39	26	430
Stage 1	-	-	-	-	-	-	194	254	-	163	223	-
Stage 2	-	-	-	-	-	-	393	222	-	446	252	-
Platoon blocked, %	-	-	-	-	-	-	-	-	-	-	-	-
Mov Cap-1 Maneuver	554	-	-	582	-	-	36	24	449	26	24	430
Mov Cap-2 Maneuver	-	-	-	-	-	-	126	109	-	101	103	-
Stage 1	-	-	-	-	-	-	188	247	-	151	206	-
Stage 2	-	-	-	-	-	-	363	205	-	327	245	-

Approach	EB			WB			NB			SB		
HCM Ctrl Dly, s/v	0.15			0.4			27.83			43.39		
HCM LOS							D			E		

Minor Lane/Major Mvmt	NBLn1	EBL	EBT	EBR	WBL	WBT	WBR	SBLn1	SBLn2
Capacity (veh/h)	293	554	-	-	582	-	-	101	-
HCM Lane V/C Ratio	0.474	0.028	-	-	0.076	-	-	0.067	-
HCM Ctrl Dly (s/v)	27.8	11.7	-	-	11.7	-	-	43.4	0
HCM Lane LOS	D	B	-	-	B	-	-	E	A
HCM 95th %tile Q(veh)	2.4	0.1	-	-	0.2	-	-	0.2	-

Intersection												
Int Delay, s/veh	1.3											
Movement	EBL	EBT	EBR	WBL	WBT	WBR	NBL	NBT	NBR	SBL	SBT	SBR
Lane Configurations	↖	↖↗		↖	↖↗			↖↗		↖	↗	
Traffic Vol, veh/h	0	270	9	39	211	1	5	0	35	2	0	1
Future Vol, veh/h	0	270	9	39	211	1	5	0	35	2	0	1
Conflicting Peds, #/hr	0	0	0	0	0	0	0	0	0	0	0	0
Sign Control	Free	Free	Free	Free	Free	Free	Stop	Stop	Stop	Stop	Stop	Stop
RT Channelized	-	-	None	-	-	None	-	-	None	-	-	None
Storage Length	200	-	-	150	-	-	-	-	-	250	-	-
Veh in Median Storage, #	-	0	-	-	0	-	-	1	-	-	1	-
Grade, %	-	0	-	-	0	-	-	0	-	-	0	-
Peak Hour Factor	86	86	86	86	86	86	86	86	86	86	86	86
Heavy Vehicles, %	0	0	0	0	0	0	0	0	0	0	0	0
Mvmt Flow	0	314	10	45	245	1	6	0	41	2	0	1

Major/Minor	Major1			Major2			Minor1			Minor2		
Conflicting Flow All	247	0	0	324	0	0	533	656	162	494	661	123
Stage 1	-	-	-	-	-	-	319	319	-	337	337	-
Stage 2	-	-	-	-	-	-	213	337	-	157	324	-
Critical Hdwy	4.1	-	-	4.1	-	-	7.5	6.5	6.9	7.5	6.5	6.9
Critical Hdwy Stg 1	-	-	-	-	-	-	6.5	5.5	-	6.5	5.5	-
Critical Hdwy Stg 2	-	-	-	-	-	-	6.5	5.5	-	6.5	5.5	-
Follow-up Hdwy	2.2	-	-	2.2	-	-	3.5	4	3.3	3.5	4	3.3
Pot Cap-1 Maneuver	1331	-	-	1247	-	-	434	388	860	463	385	911
Stage 1	-	-	-	-	-	-	672	656	-	657	645	-
Stage 2	-	-	-	-	-	-	775	645	-	835	653	-
Platoon blocked, %		-	-		-	-						
Mov Cap-1 Maneuver	1331	-	-	1247	-	-	418	373	860	425	371	911
Mov Cap-2 Maneuver	-	-	-	-	-	-	512	461	-	504	450	-
Stage 1	-	-	-	-	-	-	672	656	-	633	622	-
Stage 2	-	-	-	-	-	-	746	621	-	796	653	-

Approach	EB			WB			NB			SB		
HCM Ctrl Dly, s/v	0			1.24			9.82			11.11		
HCM LOS							A			B		

Minor Lane/Major Mvmt	NBLn1	EBL	EBT	EBR	WBL	WBT	WBR	SBLn1	SBLn2
Capacity (veh/h)	793	1331	-	-	1247	-	-	504	911
HCM Lane V/C Ratio	0.059	-	-	-	0.036	-	-	0.005	0.001
HCM Ctrl Dly (s/v)	9.8	0	-	-	8	-	-	12.2	9
HCM Lane LOS	A	A	-	-	A	-	-	B	A
HCM 95th %tile Q(veh)	0.2	0	-	-	0.1	-	-	0	0

Timings  
4: Greensborough Dr/Plaza Cir & Plaza Dr

2045 Total AM  
02/05/2026



Lane Group	EBL	EBT	WBL	WBT	NBL	NBT	SBL	SBT
Lane Configurations	↶	↷	↶	↷		↷	↶	↷
Traffic Volume (vph)	18	697	26	739	17	0	104	0
Future Volume (vph)	18	697	26	739	17	0	104	0
Turn Type	pm+pt	NA	pm+pt	NA	Perm	NA	Perm	NA
Protected Phases	5	2	1	6		8		4
Permitted Phases	2		6		8		4	
Detector Phase	5	2	1	6	8	8	4	4
Switch Phase								
Minimum Initial (s)	5.0	5.0	5.0	5.0	5.0	5.0	5.0	5.0
Minimum Split (s)	11.0	24.0	11.0	24.0	24.0	24.0	24.0	24.0
Total Split (s)	11.0	67.0	12.0	68.0	41.0	41.0	41.0	41.0
Total Split (%)	9.2%	55.8%	10.0%	56.7%	34.2%	34.2%	34.2%	34.2%
Yellow Time (s)	4.0	4.0	4.0	4.0	4.0	4.0	4.0	4.0
All-Red Time (s)	2.0	2.0	2.0	2.0	2.0	2.0	2.0	2.0
Lost Time Adjust (s)	0.0	0.0	0.0	0.0		0.0	0.0	0.0
Total Lost Time (s)	6.0	6.0	6.0	6.0		6.0	6.0	6.0
Lead/Lag	Lead	Lag	Lead	Lag				
Lead-Lag Optimize?	Yes	Yes	Yes	Yes				
Recall Mode	None	C-Max	None	C-Max	None	None	None	None

Intersection Summary

Cycle Length: 120  
 Actuated Cycle Length: 120  
 Offset: 0 (0%), Referenced to phase 2:EBTL and 6:WBTL, Start of Green  
 Natural Cycle: 65  
 Control Type: Actuated-Coordinated

Splits and Phases: 4: Greensborough Dr/Plaza Cir & Plaza Dr



HCM 7th Signalized Intersection Summary  
 4: Greensborough Dr/Plaza Cir & Plaza Dr

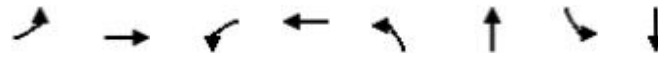
2045 Total AM  
 02/05/2026



Movement	EBL	EBT	EBR	WBL	WBT	WBR	NBL	NBT	NBR	SBL	SBT	SBR
Lane Configurations	↗	↕		↖	↕			↕		↗	↖	
Traffic Volume (veh/h)	18	697	12	26	739	25	17	0	65	104	0	11
Future Volume (veh/h)	18	697	12	26	739	25	17	0	65	104	0	11
Initial Q (Qb), veh	0	0	0	0	0	0	0	0	0	0	0	0
Lane Width Adj.	1.00	1.00	1.00	1.00	1.00	1.00	1.00	1.00	1.00	1.00	1.00	1.00
Ped-Bike Adj(A_pbT)	1.00		1.00	1.00		1.00	1.00		1.00	1.00		1.00
Parking Bus, Adj	1.00	1.00	1.00	1.00	1.00	1.00	1.00	1.00	1.00	1.00	1.00	1.00
Work Zone On Approach		No			No			No			No	
Adj Sat Flow, veh/h/ln	1885	1885	1885	1885	1885	1885	1900	1900	1900	1900	1900	1900
Adj Flow Rate, veh/h	31	1181	20	44	1253	42	29	0	110	176	0	19
Peak Hour Factor	0.59	0.59	0.59	0.59	0.59	0.59	0.59	0.59	0.59	0.59	0.59	0.59
Percent Heavy Veh, %	1	1	1	1	1	1	0	0	0	0	0	0
Cap, veh/h	302	2307	39	336	2282	76	75	20	225	260	0	286
Arrive On Green	0.03	0.64	0.64	0.03	0.65	0.65	0.18	0.00	0.18	0.18	0.00	0.18
Sat Flow, veh/h	1795	3604	61	1795	3536	118	220	113	1264	1304	0	1610
Grp Volume(v), veh/h	31	587	614	44	634	661	139	0	0	176	0	19
Grp Sat Flow(s),veh/h/ln	1795	1791	1874	1795	1791	1864	1597	0	0	1304	0	1610
Q Serve(g_s), s	0.7	21.0	21.0	1.0	23.3	23.4	2.2	0.0	0.0	9.7	0.0	1.2
Cycle Q Clear(g_c), s	0.7	21.0	21.0	1.0	23.3	23.4	9.1	0.0	0.0	18.8	0.0	1.2
Prop In Lane	1.00		0.03	1.00		0.06	0.21		0.79	1.00		1.00
Lane Grp Cap(c), veh/h	302	1147	1200	336	1156	1203	320	0	0	260	0	286
V/C Ratio(X)	0.10	0.51	0.51	0.13	0.55	0.55	0.43	0.00	0.00	0.68	0.00	0.07
Avail Cap(c_a), veh/h	328	1147	1200	368	1156	1203	498	0	0	408	0	470
HCM Platoon Ratio	1.00	1.00	1.00	1.00	1.00	1.00	1.00	1.00	1.00	1.00	1.00	1.00
Upstream Filter(I)	1.00	1.00	1.00	0.64	0.64	0.64	1.00	0.00	0.00	1.00	0.00	1.00
Uniform Delay (d), s/veh	9.1	11.6	11.6	8.6	11.7	11.7	44.3	0.0	0.0	49.2	0.0	41.1
Incr Delay (d2), s/veh	0.1	1.6	1.6	0.1	1.2	1.2	0.9	0.0	0.0	3.1	0.0	0.1
Initial Q Delay(d3), s/veh	0.0	0.0	0.0	0.0	0.0	0.0	0.0	0.0	0.0	0.0	0.0	0.0
%ile BackOfQ(95%),veh/ln	0.5	12.7	13.2	0.6	12.6	13.0	6.9	0.0	0.0	9.2	0.0	0.9
Unsig. Movement Delay, s/veh												
LnGrp Delay(d), s/veh	9.2	13.2	13.1	8.8	12.9	12.8	45.2	0.0	0.0	52.2	0.0	41.2
LnGrp LOS	A	B	B	A	B	B	D			D		D
Approach Vol, veh/h		1232			1339			139				195
Approach Delay, s/veh		13.0			12.7			45.2				51.2
Approach LOS		B			B			D				D
Timer - Assigned Phs	1	2		4	5	6		8				
Phs Duration (G+Y+Rc), s	9.8	82.8		27.3	9.2	83.5		27.3				
Change Period (Y+Rc), s	6.0	6.0		6.0	6.0	6.0		6.0				
Max Green Setting (Gmax), s	6.0	61.0		35.0	5.0	62.0		35.0				
Max Q Clear Time (g_c+I1), s	3.0	23.0		20.8	2.7	25.4		11.1				
Green Ext Time (p_c), s	0.0	9.4		0.5	0.0	10.6		0.8				
<b>Intersection Summary</b>												
HCM 7th Control Delay, s/veh					17.0							
HCM 7th LOS					B							

Timings  
4: Greensborough Dr/Plaza Cir & Plaza Dr

2045 Total PM  
02/05/2026



Lane Group	EBL	EBT	WBL	WBT	NBL	NBT	SBL	SBT
Lane Configurations	↶	↷	↶	↷		↷	↶	↷
Traffic Volume (vph)	28	353	48	297	6	0	46	0
Future Volume (vph)	28	353	48	297	6	0	46	0
Turn Type	pm+pt	NA	pm+pt	NA	Perm	NA	Perm	NA
Protected Phases	5	2	1	6		8		4
Permitted Phases	2		6		8		4	
Detector Phase	5	2	1	6	8	8	4	4
Switch Phase								
Minimum Initial (s)	5.0	5.0	5.0	5.0	5.0	5.0	5.0	5.0
Minimum Split (s)	11.0	24.0	11.0	24.0	24.0	24.0	24.0	24.0
Total Split (s)	19.0	55.0	23.0	59.0	42.0	42.0	42.0	42.0
Total Split (%)	15.8%	45.8%	19.2%	49.2%	35.0%	35.0%	35.0%	35.0%
Yellow Time (s)	4.0	4.0	4.0	4.0	4.0	4.0	4.0	4.0
All-Red Time (s)	2.0	2.0	2.0	2.0	2.0	2.0	2.0	2.0
Lost Time Adjust (s)	0.0	0.0	0.0	0.0		0.0	0.0	0.0
Total Lost Time (s)	6.0	6.0	6.0	6.0		6.0	6.0	6.0
Lead/Lag	Lead	Lag	Lead	Lag				
Lead-Lag Optimize?	Yes	Yes	Yes	Yes				
Recall Mode	None	C-Max	None	C-Max	None	None	None	None

Intersection Summary

Cycle Length: 120  
 Actuated Cycle Length: 120  
 Offset: 0 (0%), Referenced to phase 2:EBTL and 6:WBTL, Start of Green  
 Natural Cycle: 60  
 Control Type: Actuated-Coordinated

Splits and Phases: 4: Greensborough Dr/Plaza Cir & Plaza Dr



HCM 7th Signalized Intersection Summary  
4: Greensborough Dr/Plaza Cir & Plaza Dr

2045 Total PM  
02/05/2026



Movement	EBL	EBT	EBR	WBL	WBT	WBR	NBL	NBT	NBR	SBL	SBT	SBR
Lane Configurations	↗	↗↘		↗	↗↘			↕		↗	↘	
Traffic Volume (veh/h)	28	353	11	48	297	67	6	0	43	46	0	8
Future Volume (veh/h)	28	353	11	48	297	67	6	0	43	46	0	8
Initial Q (Qb), veh	0	0	0	0	0	0	0	0	0	0	0	0
Lane Width Adj.	1.00	1.00	1.00	1.00	1.00	1.00	1.00	1.00	1.00	1.00	1.00	1.00
Ped-Bike Adj(A_pbT)	1.00		1.00	1.00		1.00	1.00		1.00	1.00		1.00
Parking Bus, Adj	1.00	1.00	1.00	1.00	1.00	1.00	1.00	1.00	1.00	1.00	1.00	1.00
Work Zone On Approach		No			No			No			No	
Adj Sat Flow, veh/h/ln	1900	1900	1900	1900	1900	1900	1900	1900	1900	1900	1900	1900
Adj Flow Rate, veh/h	33	410	13	56	345	78	7	0	50	53	0	9
Peak Hour Factor	0.86	0.86	0.86	0.86	0.86	0.86	0.86	0.86	0.86	0.86	0.86	0.86
Percent Heavy Veh, %	0	0	0	0	0	0	0	0	0	0	0	0
Cap, veh/h	833	2722	86	840	2257	504	40	4	74	142	0	85
Arrive On Green	0.03	0.76	0.76	0.04	0.77	0.77	0.05	0.00	0.05	0.05	0.00	0.05
Sat Flow, veh/h	1810	3572	113	1810	2932	655	118	79	1410	1376	0	1610
Grp Volume(v), veh/h	33	207	216	56	211	212	57	0	0	53	0	9
Grp Sat Flow(s),veh/h/ln	1810	1805	1880	1810	1805	1782	1607	0	0	1376	0	1610
Q Serve(g_s), s	0.5	3.7	3.7	0.8	3.7	3.7	1.7	0.0	0.0	0.0	0.0	0.6
Cycle Q Clear(g_c), s	0.5	3.7	3.7	0.8	3.7	3.7	4.1	0.0	0.0	3.7	0.0	0.6
Prop In Lane	1.00		0.06	1.00		0.37	0.12		0.88	1.00		1.00
Lane Grp Cap(c), veh/h	833	1376	1433	840	1389	1371	118	0	0	142	0	85
V/C Ratio(X)	0.04	0.15	0.15	0.07	0.15	0.15	0.48	0.00	0.00	0.37	0.00	0.11
Avail Cap(c_a), veh/h	979	1376	1433	1032	1389	1371	510	0	0	483	0	483
HCM Platoon Ratio	1.00	1.00	1.00	1.00	1.00	1.00	1.00	1.00	1.00	1.00	1.00	1.00
Upstream Filter(I)	1.00	1.00	1.00	0.85	0.85	0.85	1.00	0.00	0.00	1.00	0.00	1.00
Uniform Delay (d), s/veh	2.7	3.8	3.8	2.6	3.6	3.6	55.8	0.0	0.0	55.6	0.0	54.2
Incr Delay (d2), s/veh	0.0	0.2	0.2	0.0	0.2	0.2	3.0	0.0	0.0	1.6	0.0	0.5
Initial Q Delay(d3), s/veh	0.0	0.0	0.0	0.0	0.0	0.0	0.0	0.0	0.0	0.0	0.0	0.0
%ile BackOfQ(95%),veh/ln	0.2	2.1	2.2	0.4	2.0	2.0	3.3	0.0	0.0	3.0	0.0	0.5
Unsig. Movement Delay, s/veh												
LnGrp Delay(d), s/veh	2.8	4.1	4.1	2.6	3.8	3.8	58.8	0.0	0.0	57.2	0.0	54.7
LnGrp LOS	A	A	A	A	A	A	E			E		D
Approach Vol, veh/h		456			479			57				62
Approach Delay, s/veh		4.0			3.7			58.8				56.9
Approach LOS		A			A			E				E
Timer - Assigned Phs	1	2		4	5	6		8				
Phs Duration (G+Y+Rc), s	10.2	97.5		12.3	9.3	98.3		12.3				
Change Period (Y+Rc), s	6.0	6.0		6.0	6.0	6.0		6.0				
Max Green Setting (Gmax), s	17.0	49.0		36.0	13.0	53.0		36.0				
Max Q Clear Time (g_c+I1), s	2.8	5.7		5.7	2.5	5.7		6.1				
Green Ext Time (p_c), s	0.1	2.5		0.2	0.0	2.5		0.3				
<b>Intersection Summary</b>												
HCM 7th Control Delay, s/veh			9.9									
HCM 7th LOS			A									

Timings  
5: Kendrick Castillo Way & Plaza Dr

2025 Existing AM  
06/09/2025

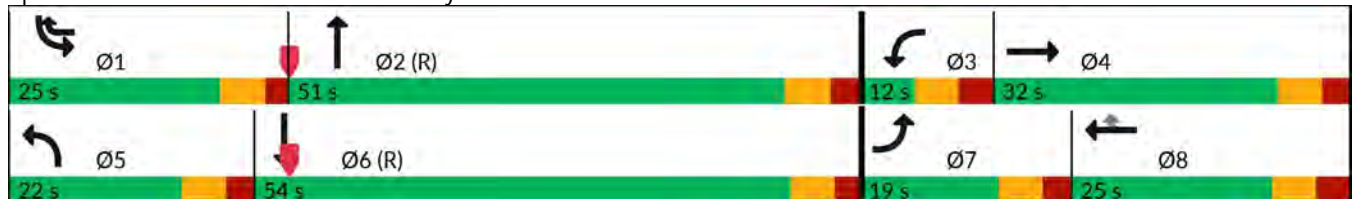


Lane Group	EBL	EBT	WBL	WBT	WBR	NBL	NBT	SBL	SBT
Lane Configurations	↶↷	↶↷	↶↷	↶↷	↶	↶↷	↶↷↶↷	↶↷	↶↷↶↷
Traffic Volume (vph)	268	193	23	126	170	238	1223	449	1004
Future Volume (vph)	268	193	23	126	170	238	1223	449	1004
Turn Type	Prot	NA	Prot	NA	pm+ov	Prot	NA	Prot	NA
Protected Phases	7	4	3	8	1	5	2	1	6
Permitted Phases					8				
Detector Phase	7	4	3	8	1	5	2	1	6
Switch Phase									
Minimum Initial (s)	5.0	5.0	5.0	5.0	5.0	5.0	5.0	5.0	5.0
Minimum Split (s)	11.5	25.0	12.0	25.0	11.0	11.5	24.5	11.0	24.0
Total Split (s)	19.0	32.0	12.0	25.0	25.0	22.0	51.0	25.0	54.0
Total Split (%)	15.8%	26.7%	10.0%	20.8%	20.8%	18.3%	42.5%	20.8%	45.0%
Yellow Time (s)	4.0	4.0	4.0	4.0	4.0	4.0	4.0	4.0	4.0
All-Red Time (s)	2.5	2.5	3.0	3.0	2.0	2.5	2.5	2.0	2.0
Lost Time Adjust (s)	0.0	0.0	0.0	0.0	0.0	0.0	0.0	0.0	0.0
Total Lost Time (s)	6.5	6.5	7.0	7.0	6.0	6.5	6.5	6.0	6.0
Lead/Lag	Lead	Lag	Lead	Lag	Lead	Lead	Lag	Lead	Lag
Lead-Lag Optimize?	Yes	Yes	Yes	Yes	Yes	Yes	Yes	Yes	Yes
Recall Mode	None	None	None	None	None	None	C-Max	None	C-Max
Act Effct Green (s)	12.4	22.4	5.0	10.2	40.2	14.5	48.4	23.1	57.0
Actuated g/C Ratio	0.10	0.19	0.04	0.09	0.34	0.12	0.40	0.19	0.48
v/c Ratio	0.83	0.51	0.18	0.47	0.30	0.64	0.72	0.76	0.60
Control Delay (s/veh)	72.8	29.8	58.6	57.3	7.9	57.2	32.9	47.0	33.5
Queue Delay	0.0	0.0	0.0	0.0	0.0	0.0	0.0	0.0	0.0
Total Delay (s/veh)	72.8	29.8	58.6	57.3	7.9	57.2	32.9	47.0	33.5
LOS	E	C	E	E	A	E	C	D	C
Approach Delay (s/veh)		48.6		31.1			36.6		37.1
Approach LOS		D		C			D		D

Intersection Summary

Cycle Length: 120  
 Actuated Cycle Length: 120  
 Offset: 54.5 (45%), Referenced to phase 2:NBT and 6:SBT, Start of Green  
 Natural Cycle: 90  
 Control Type: Actuated-Coordinated  
 Maximum v/c Ratio: 0.83  
 Intersection Signal Delay (s/veh): 38.1  
 Intersection LOS: D  
 Intersection Capacity Utilization 74.4%  
 ICU Level of Service D  
 Analysis Period (min) 15

Splits and Phases: 5: Kendrick Castillo Way & Plaza Dr



HCM 7th Signalized Intersection Summary  
5: Kendrick Castillo Way & Plaza Dr

2025 Existing AM  
06/09/2025



Movement	EBL	EBT	EBR	WBL	WBT	WBR	NBL	NBT	NBR	SBL	SBT	SBR
Lane Configurations	↔↔	↕↕		↔↔	↕↕	↗	↔↔	↕↕↕		↔↔	↕↕↕	
Traffic Volume (veh/h)	268	193	150	23	126	170	238	1223	90	449	1004	256
Future Volume (veh/h)	268	193	150	23	126	170	238	1223	90	449	1004	256
Initial Q (Qb), veh	0	0	0	0	0	0	0	0	0	0	0	0
Lane Width Adj.	1.00	1.00	1.00	1.00	1.00	1.00	1.00	1.00	1.00	1.00	1.00	1.00
Ped-Bike Adj(A_pbT)	1.00		1.00	1.00		1.00	1.00		1.00	1.00		1.00
Parking Bus, Adj	1.00	1.00	1.00	1.00	1.00	1.00	1.00	1.00	1.00	1.00	1.00	1.00
Work Zone On Approach		No			No			No			No	
Adj Sat Flow, veh/h/ln	1900	1900	1900	1870	1870	1870	1885	1885	1885	1870	1870	1870
Adj Flow Rate, veh/h	301	217	169	26	142	191	267	1374	101	504	1128	288
Peak Hour Factor	0.89	0.89	0.89	0.89	0.89	0.89	0.89	0.89	0.89	0.89	0.89	0.89
Percent Heavy Veh, %	0	0	0	2	2	2	1	1	1	2	2	2
Cap, veh/h	356	381	283	83	427	441	330	1974	145	547	1877	479
Arrive On Green	0.10	0.19	0.19	0.02	0.12	0.12	0.09	0.40	0.40	0.05	0.15	0.15
Sat Flow, veh/h	3510	1974	1467	3456	3554	1585	3483	4892	360	3456	4053	1035
Grp Volume(v), veh/h	301	197	189	26	142	191	267	964	511	504	947	469
Grp Sat Flow(s),veh/h/ln	1755	1805	1636	1728	1777	1585	1742	1716	1820	1728	1702	1684
Q Serve(g_s), s	10.1	11.9	12.6	0.9	4.4	11.9	9.0	28.0	28.0	17.4	31.2	31.2
Cycle Q Clear(g_c), s	10.1	11.9	12.6	0.9	4.4	11.9	9.0	28.0	28.0	17.4	31.2	31.2
Prop In Lane	1.00		0.90	1.00		1.00	1.00		0.20	1.00		0.61
Lane Grp Cap(c), veh/h	356	349	316	83	427	441	330	1385	735	547	1576	780
V/C Ratio(X)	0.85	0.57	0.60	0.31	0.33	0.43	0.81	0.70	0.70	0.92	0.60	0.60
Avail Cap(c_a), veh/h	366	384	348	144	533	489	450	1385	735	547	1576	780
HCM Platoon Ratio	1.00	1.00	1.00	1.00	1.00	1.00	1.00	1.00	1.00	0.33	0.33	0.33
Upstream Filter(I)	1.00	1.00	1.00	1.00	1.00	1.00	1.00	1.00	1.00	0.83	0.83	0.83
Uniform Delay (d), s/veh	53.0	43.9	44.2	57.6	48.4	35.5	53.2	29.7	29.7	56.1	40.5	40.5
Incr Delay (d2), s/veh	16.3	1.6	2.3	2.1	0.5	0.7	7.7	2.9	5.4	18.4	1.4	2.8
Initial Q Delay(d3), s/veh	0.0	0.0	0.0	0.0	0.0	0.0	0.0	0.0	0.0	0.0	0.0	0.0
%ile BackOfQ(95%),veh/ln	8.9	9.2	9.0	0.7	3.5	8.1	7.6	17.1	18.5	14.1	20.2	20.3
Unsig. Movement Delay, s/veh												
LnGrp Delay(d), s/veh	69.3	45.5	46.5	59.7	48.8	36.2	60.9	32.6	35.1	74.5	41.9	43.3
LnGrp LOS	E	D	D	E	D	D	E	C	D	E	D	D
Approach Vol, veh/h		687			359			1742			1920	
Approach Delay, s/veh		56.2			42.9			37.7			50.8	
Approach LOS		E			D			D			D	
Timer - Assigned Phs	1	2	3	4	5	6	7	8				
Phs Duration (G+Y+Rc), s	25.0	54.9	9.9	30.2	17.9	62.1	18.7	21.4				
Change Period (Y+Rc), s	6.0	6.5	7.0	* 7	6.5	* 6.5	6.5	7.0				
Max Green Setting (Gmax), s	19.0	44.5	5.0	* 26	15.5	* 48	12.5	18.0				
Max Q Clear Time (g_c+I1), s	19.4	30.0	2.9	14.6	11.0	33.2	12.1	13.9				
Green Ext Time (p_c), s	0.0	7.9	0.0	1.6	0.4	8.0	0.0	0.5				

Intersection Summary												
HCM 7th Control Delay, s/veh											46.1	
HCM 7th LOS											D	

Notes  
\* HCM 7th computational engine requires equal clearance times for the phases crossing the barrier.

Timings  
5: Kendrick Castillo Way & Plaza Dr

2025 Existing PM  
06/09/2025



Lane Group	EBL	EBT	WBL	WBT	WBR	NBL	NBT	SBL	SBT
Lane Configurations	↶↷	↶↷	↶↷	↶↷	↶	↶↷	↶↷↶	↶↷	↶↷↶
Traffic Volume (vph)	256	122	124	82	360	87	1337	203	1461
Future Volume (vph)	256	122	124	82	360	87	1337	203	1461
Turn Type	Prot	NA	Prot	NA	pm+ov	Prot	NA	Prot	NA
Protected Phases	7	4	3	8	1	5	2	1	6
Permitted Phases	8								
Detector Phase	7	4	3	8	1	5	2	1	6
Switch Phase									
Minimum Initial (s)	5.0	5.0	5.0	5.0	5.0	5.0	5.0	5.0	5.0
Minimum Split (s)	11.5	25.0	12.0	25.0	11.0	11.5	24.5	11.0	24.0
Total Split (s)	25.0	32.0	18.0	25.0	28.0	16.0	62.0	28.0	74.0
Total Split (%)	17.9%	22.9%	12.9%	17.9%	20.0%	11.4%	44.3%	20.0%	52.9%
Yellow Time (s)	4.0	4.0	4.0	4.0	4.0	4.0	4.0	4.0	4.0
All-Red Time (s)	2.5	2.5	3.0	3.0	2.0	2.5	2.5	2.0	2.0
Lost Time Adjust (s)	0.0	0.0	0.0	0.0	0.0	0.0	0.0	0.0	0.0
Total Lost Time (s)	6.5	6.5	7.0	7.0	6.0	6.5	6.5	6.0	6.0
Lead/Lag	Lead	Lag	Lead	Lag	Lead	Lead	Lag	Lead	Lag
Lead-Lag Optimize?	Yes	Yes	Yes	Yes	Yes	Yes	Yes	Yes	Yes
Recall Mode	None	None	None	None	None	None	C-Max	None	C-Max
Act Effct Green (s)	16.0	14.8	10.0	8.9	36.4	9.2	68.6	20.5	79.9
Actuated g/C Ratio	0.11	0.11	0.07	0.06	0.26	0.07	0.49	0.15	0.57
v/c Ratio	0.70	0.62	0.54	0.39	0.77	0.42	0.61	0.44	0.61
Control Delay (s/veh)	69.3	35.2	70.9	67.7	40.7	67.9	28.8	55.8	21.4
Queue Delay	0.0	0.0	0.0	0.0	0.0	0.0	0.0	0.0	0.0
Total Delay (s/veh)	69.3	35.2	70.9	67.7	40.7	67.9	28.8	55.8	21.4
LOS	E	D	E	E	D	E	C	E	C
Approach Delay (s/veh)	51.7		51.2			31.1		25.2	
Approach LOS	D		D			C		C	

Intersection Summary

Cycle Length: 140  
 Actuated Cycle Length: 140  
 Offset: 0 (0%), Referenced to phase 2:NBT and 6:SBT, Start of Green  
 Natural Cycle: 90  
 Control Type: Actuated-Coordinated  
 Maximum v/c Ratio: 0.77  
 Intersection Signal Delay (s/veh): 33.7  
 Intersection LOS: C  
 Intersection Capacity Utilization 72.6%  
 ICU Level of Service C  
 Analysis Period (min) 15

Splits and Phases: 5: Kendrick Castillo Way & Plaza Dr



HCM 7th Signalized Intersection Summary  
5: Kendrick Castillo Way & Plaza Dr

2025 Existing PM  
06/09/2025



Movement	EBL	EBT	EBR	WBL	WBT	WBR	NBL	NBT	NBR	SBL	SBT	SBR
Lane Configurations	↔↔	↕↕		↔↔	↕↕	↗	↔↔	↕↕↕		↔↔	↕↕↕	
Traffic Volume (veh/h)	256	122	153	124	82	360	87	1337	62	203	1461	157
Future Volume (veh/h)	256	122	153	124	82	360	87	1337	62	203	1461	157
Initial Q (Qb), veh	0	0	0	0	0	0	0	0	0	0	0	0
Lane Width Adj.	1.00	1.00	1.00	1.00	1.00	1.00	1.00	1.00	1.00	1.00	1.00	1.00
Ped-Bike Adj(A_pbT)	1.00		1.00	1.00		1.00	1.00		1.00	1.00		1.00
Parking Bus, Adj	1.00	1.00	1.00	1.00	1.00	1.00	1.00	1.00	1.00	1.00	1.00	1.00
Work Zone On Approach		No			No			No			No	
Adj Sat Flow, veh/h/ln	1900	1900	1900	1900	1900	1900	1900	1900	1900	1900	1900	1900
Adj Flow Rate, veh/h	281	134	168	136	90	330	96	1469	68	223	1605	173
Peak Hour Factor	0.91	0.91	0.91	0.91	0.91	0.91	0.91	0.91	0.91	0.91	0.91	0.91
Percent Heavy Veh, %	0	0	0	0	0	0	0	0	0	0	0	0
Cap, veh/h	337	303	271	186	464	336	143	2587	120	282	2592	279
Arrive On Green	0.10	0.17	0.17	0.05	0.13	0.13	0.04	0.51	0.51	0.08	0.55	0.55
Sat Flow, veh/h	3510	1805	1610	3510	3610	1610	3510	5081	235	3510	4754	512
Grp Volume(v), veh/h	281	134	168	136	90	330	96	1000	537	223	1167	611
Grp Sat Flow(s),veh/h/ln	1755	1805	1610	1755	1805	1610	1755	1729	1858	1755	1729	1808
Q Serve(g_s), s	11.0	9.3	13.6	5.3	3.1	18.0	3.8	27.9	28.0	8.7	32.4	32.5
Cycle Q Clear(g_c), s	11.0	9.3	13.6	5.3	3.1	18.0	3.8	27.9	28.0	8.7	32.4	32.5
Prop In Lane	1.00		1.00	1.00		1.00	1.00		0.13	1.00		0.28
Lane Grp Cap(c), veh/h	337	303	271	186	464	336	143	1761	946	282	1885	986
V/C Ratio(X)	0.83	0.44	0.62	0.73	0.19	0.98	0.67	0.57	0.57	0.79	0.62	0.62
Avail Cap(c_a), veh/h	464	329	293	276	464	336	238	1761	946	552	1885	986
HCM Platoon Ratio	1.00	1.00	1.00	1.00	1.00	1.00	1.00	1.00	1.00	1.00	1.00	1.00
Upstream Filter(I)	1.00	1.00	1.00	1.00	1.00	1.00	1.00	1.00	1.00	0.88	0.88	0.88
Uniform Delay (d), s/veh	62.2	52.3	54.1	65.3	54.5	55.1	66.2	23.7	23.7	63.2	21.8	21.9
Incr Delay (d2), s/veh	9.0	1.0	3.5	5.4	0.2	43.7	5.4	1.3	2.5	4.4	1.4	2.6
Initial Q Delay(d3), s/veh	0.0	0.0	0.0	0.0	0.0	0.0	0.0	0.0	0.0	0.0	0.0	0.0
%ile BackOfQ(95%),veh/ln	9.1	7.7	9.6	4.5	2.6	21.9	3.2	16.8	18.2	7.1	18.5	19.7
Unsig. Movement Delay, s/veh												
LnGrp Delay(d), s/veh	71.2	53.3	57.6	70.7	54.7	98.8	71.6	25.1	26.2	67.6	23.2	24.5
LnGrp LOS	E	D	E	E	D	F	E	C	C	E	C	C
Approach Vol, veh/h		583			556			1633			2001	
Approach Delay, s/veh		63.2			84.8			28.2			28.5	
Approach LOS		E			F			C			C	
Timer - Assigned Phs	1	2	3	4	5	6	7	8				
Phs Duration (G+Y+Rc), s	17.3	77.8	14.4	30.5	12.2	82.8	20.0	25.0				
Change Period (Y+Rc), s	6.0	6.5	7.0	* 7	6.5	* 6.5	6.5	7.0				
Max Green Setting (Gmax), s	22.0	55.5	11.0	* 26	9.5	* 68	18.5	18.0				
Max Q Clear Time (g_c+I1), s	10.7	30.0	7.3	15.6	5.8	34.5	13.0	20.0				
Green Ext Time (p_c), s	0.5	11.2	0.1	1.1	0.1	16.2	0.4	0.0				

Intersection Summary												
HCM 7th Control Delay, s/veh											39.2	
HCM 7th LOS											D	

Notes  
\* HCM 7th computational engine requires equal clearance times for the phases crossing the barrier.

Timings  
5: Kendrick Castillo Way & Plaza Dr

2028 Background AM  
06/09/2025

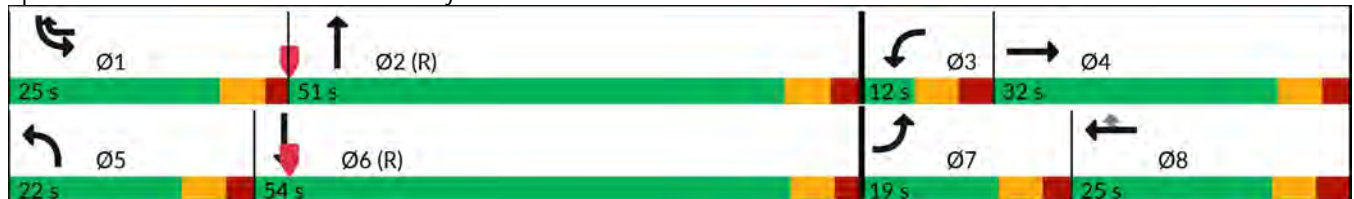


Lane Group	EBL	EBT	WBL	WBT	WBR	NBL	NBT	SBL	SBT
Lane Configurations	↶↷	↶↷	↶↷	↶↷	↶	↶↷	↶↷↷	↶↷	↶↷↷
Traffic Volume (vph)	301	207	24	132	175	249	1260	463	1034
Future Volume (vph)	301	207	24	132	175	249	1260	463	1034
Turn Type	Prot	NA	Prot	NA	pm+ov	Prot	NA	Prot	NA
Protected Phases	7	4	3	8	1	5	2	1	6
Permitted Phases	8								
Detector Phase	7	4	3	8	1	5	2	1	6
Switch Phase									
Minimum Initial (s)	5.0	5.0	5.0	5.0	5.0	5.0	5.0	5.0	5.0
Minimum Split (s)	11.5	25.0	12.0	25.0	11.0	11.5	24.5	11.0	24.0
Total Split (s)	19.0	32.0	12.0	25.0	25.0	22.0	51.0	25.0	54.0
Total Split (%)	15.8%	26.7%	10.0%	20.8%	20.8%	18.3%	42.5%	20.8%	45.0%
Yellow Time (s)	4.0	4.0	4.0	4.0	4.0	4.0	4.0	4.0	4.0
All-Red Time (s)	2.5	2.5	3.0	3.0	2.0	2.5	2.5	2.0	2.0
Lost Time Adjust (s)	0.0	0.0	0.0	0.0	0.0	0.0	0.0	0.0	0.0
Total Lost Time (s)	6.5	6.5	7.0	7.0	6.0	6.5	6.5	6.0	6.0
Lead/Lag	Lead	Lag	Lead	Lag	Lead	Lead	Lag	Lead	Lag
Lead-Lag Optimize?	Yes	Yes	Yes	Yes	Yes	Yes	Yes	Yes	Yes
Recall Mode	None	None	None	None	None	None	C-Max	None	C-Max
Act Effct Green (s)	12.5	22.8	5.0	10.5	41.1	14.9	47.4	23.6	56.1
Actuated g/C Ratio	0.10	0.19	0.04	0.09	0.34	0.12	0.40	0.20	0.47
v/c Ratio	0.93	0.55	0.19	0.48	0.31	0.65	0.75	0.77	0.63
Control Delay (s/veh)	85.7	30.9	58.8	56.9	8.3	57.1	34.5	47.1	34.6
Queue Delay	0.0	0.0	0.0	0.0	0.0	0.0	0.0	0.0	0.0
Total Delay (s/veh)	85.7	30.9	58.8	56.9	8.3	57.1	34.5	47.1	34.6
LOS	F	C	E	E	A	E	C	D	C
Approach Delay (s/veh)	55.2		31.3			38.0		37.9	
Approach LOS	E		C			D		D	

Intersection Summary

Cycle Length: 120  
 Actuated Cycle Length: 120  
 Offset: 54.5 (45%), Referenced to phase 2:NBT and 6:SBT, Start of Green  
 Natural Cycle: 100  
 Control Type: Actuated-Coordinated  
 Maximum v/c Ratio: 0.93  
 Intersection Signal Delay (s/veh): 40.1      Intersection LOS: D  
 Intersection Capacity Utilization 76.6%      ICU Level of Service D  
 Analysis Period (min) 15

Splits and Phases: 5: Kendrick Castillo Way & Plaza Dr



HCM 7th Signalized Intersection Summary  
5: Kendrick Castillo Way & Plaza Dr

2028 Background AM  
06/09/2025



Movement	EBL	EBT	EBR	WBL	WBT	WBR	NBL	NBT	NBR	SBL	SBT	SBR
Lane Configurations	↔↔	↕↕		↔↔	↕↕	↗	↔↔	↕↕↕		↔↔	↕↕↕	
Traffic Volume (veh/h)	301	207	169	24	132	175	249	1260	93	463	1034	272
Future Volume (veh/h)	301	207	169	24	132	175	249	1260	93	463	1034	272
Initial Q (Qb), veh	0	0	0	0	0	0	0	0	0	0	0	0
Lane Width Adj.	1.00	1.00	1.00	1.00	1.00	1.00	1.00	1.00	1.00	1.00	1.00	1.00
Ped-Bike Adj(A_pbT)	1.00		1.00	1.00		1.00	1.00		1.00	1.00		1.00
Parking Bus, Adj	1.00	1.00	1.00	1.00	1.00	1.00	1.00	1.00	1.00	1.00	1.00	1.00
Work Zone On Approach		No			No			No			No	
Adj Sat Flow, veh/h/ln	1900	1900	1900	1870	1870	1870	1885	1885	1885	1870	1870	1870
Adj Flow Rate, veh/h	338	233	190	27	148	197	280	1416	104	520	1162	306
Peak Hour Factor	0.89	0.89	0.89	0.89	0.89	0.89	0.89	0.89	0.89	0.89	0.89	0.89
Percent Heavy Veh, %	0	0	0	2	2	2	1	1	1	2	2	2
Cap, veh/h	366	383	299	85	437	446	343	1946	143	547	1825	481
Arrive On Green	0.10	0.20	0.20	0.02	0.12	0.12	0.10	0.40	0.40	0.05	0.15	0.15
Sat Flow, veh/h	3510	1928	1506	3456	3554	1585	3483	4892	359	3456	4024	1060
Grp Volume(v), veh/h	338	217	206	27	148	197	280	993	527	520	983	485
Grp Sat Flow(s),veh/h/ln	1755	1805	1629	1728	1777	1585	1742	1716	1821	1728	1702	1680
Q Serve(g_s), s	11.5	13.2	13.9	0.9	4.6	12.2	9.5	29.4	29.4	18.0	32.6	32.6
Cycle Q Clear(g_c), s	11.5	13.2	13.9	0.9	4.6	12.2	9.5	29.4	29.4	18.0	32.6	32.6
Prop In Lane	1.00		0.92	1.00		1.00	1.00		0.20	1.00		0.63
Lane Grp Cap(c), veh/h	366	358	323	85	437	446	343	1365	724	547	1544	762
V/C Ratio(X)	0.92	0.61	0.64	0.32	0.34	0.44	0.82	0.73	0.73	0.95	0.64	0.64
Avail Cap(c_a), veh/h	366	384	346	144	533	489	450	1365	724	547	1544	762
HCM Platoon Ratio	1.00	1.00	1.00	1.00	1.00	1.00	1.00	1.00	1.00	0.33	0.33	0.33
Upstream Filter(I)	1.00	1.00	1.00	1.00	1.00	1.00	1.00	1.00	1.00	0.81	0.81	0.81
Uniform Delay (d), s/veh	53.3	43.8	44.1	57.5	48.1	35.4	53.0	30.6	30.6	56.4	41.7	41.7
Incr Delay (d2), s/veh	28.7	2.5	3.5	2.1	0.5	0.7	8.7	3.4	6.3	23.1	1.6	3.3
Initial Q Delay(d3), s/veh	0.0	0.0	0.0	0.0	0.0	0.0	0.0	0.0	0.0	0.0	0.0	0.0
%ile BackOfQ(95%),veh/ln	10.6	10.0	9.8	0.8	3.6	8.3	7.9	17.9	19.5	14.8	20.9	21.1
Unsig. Movement Delay, s/veh												
LnGrp Delay(d), s/veh	82.0	46.3	47.6	59.6	48.6	36.1	61.7	34.1	36.9	79.5	43.4	45.0
LnGrp LOS	F	D	D	E	D	D	E	C	D	E	D	D
Approach Vol, veh/h		761			372			1800			1988	
Approach Delay, s/veh		62.5			42.8			39.2			53.2	
Approach LOS		E			D			D			D	
Timer - Assigned Phs	1	2	3	4	5	6	7	8				
Phs Duration (G+Y+Rc), s	25.0	54.2	10.0	30.8	18.3	60.9	19.0	21.8				
Change Period (Y+Rc), s	6.0	6.5	7.0	* 7	6.5	* 6.5	6.5	7.0				
Max Green Setting (Gmax), s	19.0	44.5	5.0	* 26	15.5	* 48	12.5	18.0				
Max Q Clear Time (g_c+I1), s	20.0	31.4	2.9	15.9	11.5	34.6	13.5	14.2				
Green Ext Time (p_c), s	0.0	7.6	0.0	1.6	0.3	7.8	0.0	0.5				

Intersection Summary												
HCM 7th Control Delay, s/veh				48.7								
HCM 7th LOS				D								

Notes  
\* HCM 7th computational engine requires equal clearance times for the phases crossing the barrier.



HCM 7th Signalized Intersection Summary  
5: Kendrick Castillo Way & Plaza Dr

2028 Background PM  
06/10/2025



Movement	EBL	EBT	EBR	WBL	WBT	WBR	NBL	NBT	NBR	SBL	SBT	SBR
Lane Configurations	↔↔	↑↔		↔↔	↑↑	↔	↔↔	↑↑↔		↔↔	↑↑↔	
Traffic Volume (veh/h)	277	130	165	128	90	371	101	1378	64	209	1505	182
Future Volume (veh/h)	277	130	165	128	90	371	101	1378	64	209	1505	182
Initial Q (Qb), veh	0	0	0	0	0	0	0	0	0	0	0	0
Lane Width Adj.	1.00	1.00	1.00	1.00	1.00	1.00	1.00	1.00	1.00	1.00	1.00	1.00
Ped-Bike Adj(A_pbT)	1.00		1.00	1.00		1.00	1.00		1.00	1.00		1.00
Parking Bus, Adj	1.00	1.00	1.00	1.00	1.00	1.00	1.00	1.00	1.00	1.00	1.00	1.00
Work Zone On Approach		No			No			No			No	
Adj Sat Flow, veh/h/ln	1900	1900	1900	1900	1900	1900	1900	1900	1900	1900	1900	1900
Adj Flow Rate, veh/h	304	143	181	141	99	342	111	1514	70	230	1654	200
Peak Hour Factor	0.91	0.91	0.91	0.91	0.91	0.91	0.91	0.91	0.91	0.91	0.91	0.91
Percent Heavy Veh, %	0	0	0	0	0	0	0	0	0	0	0	0
Cap, veh/h	360	312	279	191	464	340	159	2544	118	289	2506	302
Arrive On Green	0.10	0.17	0.17	0.05	0.13	0.13	0.05	0.50	0.50	0.08	0.53	0.53
Sat Flow, veh/h	3510	1805	1610	3510	3610	1610	3510	5081	235	3510	4691	566
Grp Volume(v), veh/h	304	143	181	141	99	342	111	1030	554	230	1218	636
Grp Sat Flow(s),veh/h/ln	1755	1805	1610	1755	1805	1610	1755	1729	1858	1755	1729	1798
Q Serve(g_s), s	11.9	10.0	14.7	5.5	3.4	18.0	4.4	29.7	29.7	9.0	35.5	35.7
Cycle Q Clear(g_c), s	11.9	10.0	14.7	5.5	3.4	18.0	4.4	29.7	29.7	9.0	35.5	35.7
Prop In Lane	1.00		1.00	1.00		1.00	1.00		0.13	1.00		0.31
Lane Grp Cap(c), veh/h	360	312	279	191	464	340	159	1732	930	289	1848	961
V/C Ratio(X)	0.84	0.46	0.65	0.74	0.21	1.01	0.70	0.60	0.60	0.79	0.66	0.66
Avail Cap(c_a), veh/h	464	329	293	276	464	340	238	1732	930	552	1848	961
HCM Platoon Ratio	1.00	1.00	1.00	1.00	1.00	1.00	1.00	1.00	1.00	1.00	1.00	1.00
Upstream Filter(I)	1.00	1.00	1.00	1.00	1.00	1.00	1.00	1.00	1.00	0.84	0.84	0.84
Uniform Delay (d), s/veh	61.7	52.0	53.9	65.2	54.7	55.2	65.9	24.9	24.9	63.1	23.4	23.5
Incr Delay (d2), s/veh	10.8	1.0	4.7	5.9	0.2	50.5	5.4	1.5	2.8	4.2	1.6	3.0
Initial Q Delay(d3), s/veh	0.0	0.0	0.0	0.0	0.0	0.0	0.0	0.0	0.0	0.0	0.0	0.0
%ile BackOfQ(95%),veh/ln	9.7	8.1	10.3	4.7	2.8	23.3	3.7	17.7	19.2	7.2	20.0	21.2
Unsig. Movement Delay, s/veh												
LnGrp Delay(d), s/veh	72.6	53.0	58.6	71.1	54.9	105.7	71.3	26.4	27.7	67.2	25.0	26.5
LnGrp LOS	E	D	E	E	D	F	E	C	C	E	C	C
Approach Vol, veh/h		628			582			1695			2084	
Approach Delay, s/veh		64.1			88.7			29.7			30.1	
Approach LOS		E			F			C			C	
Timer - Assigned Phs	1	2	3	4	5	6	7	8				
Phs Duration (G+Y+Rc), s	17.5	76.6	14.6	31.2	12.9	81.3	20.8	25.0				
Change Period (Y+Rc), s	6.0	6.5	7.0	* 7	6.5	* 6.5	6.5	7.0				
Max Green Setting (Gmax), s	22.0	55.5	11.0	* 26	9.5	* 68	18.5	18.0				
Max Q Clear Time (g_c+I1), s	11.0	31.7	7.5	16.7	6.4	37.7	13.9	20.0				
Green Ext Time (p_c), s	0.5	11.3	0.1	1.2	0.1	16.3	0.4	0.0				

Intersection Summary												
HCM 7th Control Delay, s/veh				41.1								
HCM 7th LOS				D								

Notes  
\* HCM 7th computational engine requires equal clearance times for the phases crossing the barrier.

Timings  
5: Kendrick Castillo Way & Plaza Dr

2028 Total AM  
02/05/2026



Lane Group	EBL	EBT	WBL	WBT	WBR	NBL	NBT	SBL	SBT
Lane Configurations	↔↔	↕↕	↔↔	↕↕	↕	↔↔	↕↕↕	↔↔	↕↕↕
Traffic Volume (vph)	338	218	24	135	175	256	1260	463	1034
Future Volume (vph)	338	218	24	135	175	256	1260	463	1034
Turn Type	Prot	NA	Prot	NA	pm+ov	Prot	NA	Prot	NA
Protected Phases	7	4	3	8	1	5	2	1	6
Permitted Phases					8				
Detector Phase	7	4	3	8	1	5	2	1	6
Switch Phase									
Minimum Initial (s)	5.0	5.0	5.0	5.0	5.0	5.0	5.0	5.0	5.0
Minimum Split (s)	11.5	25.0	12.0	25.0	11.0	11.5	24.5	11.0	24.0
Total Split (s)	19.0	32.0	12.0	25.0	25.0	22.0	51.0	25.0	54.0
Total Split (%)	15.8%	26.7%	10.0%	20.8%	20.8%	18.3%	42.5%	20.8%	45.0%
Yellow Time (s)	4.0	4.0	4.0	4.0	4.0	4.0	4.0	4.0	4.0
All-Red Time (s)	2.5	2.5	3.0	3.0	2.0	2.5	2.5	2.0	2.0
Lost Time Adjust (s)	0.0	0.0	0.0	0.0	0.0	0.0	0.0	0.0	0.0
Total Lost Time (s)	6.5	6.5	7.0	7.0	6.0	6.5	6.5	6.0	6.0
Lead/Lag	Lead	Lag	Lead	Lag	Lead	Lead	Lag	Lead	Lag
Lead-Lag Optimize?	Yes	Yes	Yes	Yes	Yes	Yes	Yes	Yes	Yes
Recall Mode	None	None	None	None	None	None	C-Max	None	C-Max

Intersection Summary

Cycle Length: 120  
 Actuated Cycle Length: 120  
 Offset: 54.5 (45%), Referenced to phase 2:NBT and 6:SBT, Start of Green  
 Natural Cycle: 100  
 Control Type: Actuated-Coordinated

Splits and Phases: 5: Kendrick Castillo Way & Plaza Dr



HCM 7th Signalized Intersection Summary  
5: Kendrick Castillo Way & Plaza Dr

2028 Total AM  
02/05/2026



Movement	EBL	EBT	EBR	WBL	WBT	WBR	NBL	NBT	NBR	SBL	SBT	SBR
Lane Configurations	↔↔	↑↓		↔↔	↑↑	↔	↔↔	↑↑↓		↔↔	↑↑↓	
Traffic Volume (veh/h)	338	218	190	24	135	175	256	1260	93	463	1034	284
Future Volume (veh/h)	338	218	190	24	135	175	256	1260	93	463	1034	284
Initial Q (Qb), veh	0	0	0	0	0	0	0	0	0	0	0	0
Lane Width Adj.	1.00	1.00	1.00	1.00	1.00	1.00	1.00	1.00	1.00	1.00	1.00	1.00
Ped-Bike Adj(A_pbT)	1.00		1.00	1.00		1.00	1.00		1.00	1.00		1.00
Parking Bus, Adj	1.00	1.00	1.00	1.00	1.00	1.00	1.00	1.00	1.00	1.00	1.00	1.00
Work Zone On Approach		No			No			No			No	
Adj Sat Flow, veh/h/ln	1900	1900	1900	1870	1870	1870	1885	1885	1885	1870	1870	1870
Adj Flow Rate, veh/h	380	245	213	27	152	197	288	1416	104	520	1162	319
Peak Hour Factor	0.89	0.89	0.89	0.89	0.89	0.89	0.89	0.89	0.89	0.89	0.89	0.89
Percent Heavy Veh, %	0	0	0	2	2	2	1	1	1	2	2	2
Cap, veh/h	366	370	309	85	438	446	350	1946	143	547	1798	494
Arrive On Green	0.10	0.20	0.20	0.02	0.12	0.12	0.10	0.40	0.40	0.16	0.45	0.45
Sat Flow, veh/h	3510	1867	1558	3456	3554	1585	3483	4892	359	3456	3984	1094
Grp Volume(v), veh/h	380	237	221	27	152	197	288	993	527	520	993	488
Grp Sat Flow(s),veh/h/ln	1755	1805	1620	1728	1777	1585	1742	1716	1821	1728	1702	1674
Q Serve(g_s), s	12.5	14.5	15.2	0.9	4.7	12.2	9.7	29.4	29.4	17.9	27.1	27.1
Cycle Q Clear(g_c), s	12.5	14.5	15.2	0.9	4.7	12.2	9.7	29.4	29.4	17.9	27.1	27.1
Prop In Lane	1.00		0.96	1.00		1.00	1.00		0.20	1.00		0.65
Lane Grp Cap(c), veh/h	366	358	321	85	438	446	350	1364	724	547	1536	755
V/C Ratio(X)	1.04	0.66	0.69	0.32	0.35	0.44	0.82	0.73	0.73	0.95	0.65	0.65
Avail Cap(c_a), veh/h	366	384	344	144	533	489	450	1364	724	547	1536	755
HCM Platoon Ratio	1.00	1.00	1.00	1.00	1.00	1.00	1.00	1.00	1.00	1.00	1.00	1.00
Upstream Filter(I)	1.00	1.00	1.00	1.00	1.00	1.00	1.00	1.00	1.00	0.81	0.81	0.81
Uniform Delay (d), s/veh	53.8	44.4	44.7	57.5	48.2	35.4	52.9	30.6	30.6	50.0	25.5	25.5
Incr Delay (d2), s/veh	57.6	3.8	5.3	2.1	0.5	0.7	9.3	3.4	6.3	23.1	1.7	3.5
Initial Q Delay(d3), s/veh	0.0	0.0	0.0	0.0	0.0	0.0	0.0	0.0	0.0	0.0	0.0	0.0
%ile BackOfQ(95%),veh/ln	13.3	11.0	10.6	0.8	3.8	8.3	8.1	17.9	19.5	13.8	15.7	15.9
Unsig. Movement Delay, s/veh												
LnGrp Delay(d), s/veh	111.3	48.2	49.9	59.6	48.7	36.1	62.2	34.1	37.0	73.2	27.2	29.0
LnGrp LOS	F	D	D	E	D	D	E	C	D	E	C	C
Approach Vol, veh/h		838			376			1808			2001	
Approach Delay, s/veh		77.3			42.8			39.4			39.6	
Approach LOS		E			D			D			D	
Timer - Assigned Phs	1	2	3	4	5	6	7	8				
Phs Duration (G+Y+Rc), s	25.0	54.2	10.0	30.8	18.6	60.6	19.0	21.8				
Change Period (Y+Rc), s	6.0	6.5	7.0	* 7	6.5	* 6.5	6.5	7.0				
Max Green Setting (Gmax), s	19.0	44.5	5.0	* 26	15.5	* 48	12.5	18.0				
Max Q Clear Time (g_c+I1), s	19.9	31.4	2.9	17.2	11.7	29.1	14.5	14.2				
Green Ext Time (p_c), s	0.0	7.6	0.0	1.7	0.3	9.7	0.0	0.5				
<b>Intersection Summary</b>												
HCM 7th Control Delay, s/veh			46.0									
HCM 7th LOS			D									
<b>Notes</b>												
* HCM 7th computational engine requires equal clearance times for the phases crossing the barrier.												

Timings  
5: Kendrick Castillo Way & Plaza Dr

2028 Total PM  
02/05/2026



Lane Group	EBL	EBT	WBL	WBT	WBR	NBL	NBT	SBL	SBT
Lane Configurations	↔↔	↕↕	↔↔	↕↕	↕	↔↔	↕↕	↔↔	↕↕
Traffic Volume (vph)	301	137	128	101	371	122	1378	209	1505
Future Volume (vph)	301	137	128	101	371	122	1378	209	1505
Turn Type	Prot	NA	Prot	NA	pm+ov	Prot	NA	Prot	NA
Protected Phases	7	4	3	8	1	5	2	1	6
Permitted Phases					8				
Detector Phase	7	4	3	8	1	5	2	1	6
Switch Phase									
Minimum Initial (s)	5.0	5.0	5.0	5.0	5.0	5.0	5.0	5.0	5.0
Minimum Split (s)	11.5	25.0	12.0	25.0	11.0	11.5	24.5	11.0	24.0
Total Split (s)	25.0	32.0	18.0	25.0	28.0	16.0	62.0	28.0	74.0
Total Split (%)	17.9%	22.9%	12.9%	17.9%	20.0%	11.4%	44.3%	20.0%	52.9%
Yellow Time (s)	4.0	4.0	4.0	4.0	4.0	4.0	4.0	4.0	4.0
All-Red Time (s)	2.5	2.5	3.0	3.0	2.0	2.5	2.5	2.0	2.0
Lost Time Adjust (s)	0.0	0.0	0.0	0.0	0.0	0.0	0.0	0.0	0.0
Total Lost Time (s)	6.5	6.5	7.0	7.0	6.0	6.5	6.5	6.0	6.0
Lead/Lag	Lead	Lag	Lead	Lag	Lead	Lead	Lag	Lead	Lag
Lead-Lag Optimize?	Yes	Yes	Yes	Yes	Yes	Yes	Yes	Yes	Yes
Recall Mode	None	None	None	None	None	None	C-Max	None	C-Max

Intersection Summary

Cycle Length: 140  
 Actuated Cycle Length: 140  
 Offset: 0 (0%), Referenced to phase 2:NBT and 6:SBT, Start of Green  
 Natural Cycle: 90  
 Control Type: Actuated-Coordinated

Splits and Phases: 5: Kendrick Castillo Way & Plaza Dr



HCM 7th Signalized Intersection Summary  
5: Kendrick Castillo Way & Plaza Dr

2028 Total PM  
02/05/2026



Movement	EBL	EBT	EBR	WBL	WBT	WBR	NBL	NBT	NBR	SBL	SBT	SBR
Lane Configurations	↔↔	↕↕		↔↔	↕↕	↗	↔↔	↕↕↕		↔↔	↕↕↕	
Traffic Volume (veh/h)	301	137	179	128	101	371	122	1378	64	209	1505	219
Future Volume (veh/h)	301	137	179	128	101	371	122	1378	64	209	1505	219
Initial Q (Qb), veh	0	0	0	0	0	0	0	0	0	0	0	0
Lane Width Adj.	1.00	1.00	1.00	1.00	1.00	1.00	1.00	1.00	1.00	1.00	1.00	1.00
Ped-Bike Adj(A_pbT)	1.00		1.00	1.00		1.00	1.00		1.00	1.00		1.00
Parking Bus, Adj	1.00	1.00	1.00	1.00	1.00	1.00	1.00	1.00	1.00	1.00	1.00	1.00
Work Zone On Approach		No			No			No			No	
Adj Sat Flow, veh/h/ln	1900	1900	1900	1900	1900	1900	1900	1900	1900	1900	1900	1900
Adj Flow Rate, veh/h	331	151	197	141	111	342	134	1514	70	230	1654	241
Peak Hour Factor	0.91	0.91	0.91	0.91	0.91	0.91	0.91	0.91	0.91	0.91	0.91	0.91
Percent Heavy Veh, %	0	0	0	0	0	0	0	0	0	0	0	0
Cap, veh/h	385	326	290	191	464	340	183	2507	116	289	2380	345
Arrive On Green	0.11	0.18	0.18	0.05	0.13	0.13	0.05	0.49	0.49	0.08	0.52	0.52
Sat Flow, veh/h	3510	1805	1610	3510	3610	1610	3510	5081	235	3510	4575	664
Grp Volume(v), veh/h	331	151	197	141	111	342	134	1030	554	230	1249	646
Grp Sat Flow(s),veh/h/ln	1755	1805	1610	1755	1805	1610	1755	1729	1858	1755	1729	1781
Q Serve(g_s), s	13.0	10.5	16.0	5.5	3.9	18.0	5.3	30.1	30.1	9.0	38.0	38.3
Cycle Q Clear(g_c), s	13.0	10.5	16.0	5.5	3.9	18.0	5.3	30.1	30.1	9.0	38.0	38.3
Prop In Lane	1.00		1.00	1.00		1.00	1.00		0.13	1.00		0.37
Lane Grp Cap(c), veh/h	385	326	290	191	464	340	183	1706	917	289	1799	926
V/C Ratio(X)	0.86	0.46	0.68	0.74	0.24	1.01	0.73	0.60	0.60	0.79	0.69	0.70
Avail Cap(c_a), veh/h	464	329	293	276	464	340	238	1706	917	552	1799	926
HCM Platoon Ratio	1.00	1.00	1.00	1.00	1.00	1.00	1.00	1.00	1.00	1.00	1.00	1.00
Upstream Filter(I)	1.00	1.00	1.00	1.00	1.00	1.00	1.00	1.00	1.00	0.83	0.83	0.83
Uniform Delay (d), s/veh	61.2	51.3	53.6	65.2	54.8	55.2	65.4	25.6	25.6	63.1	25.2	25.3
Incr Delay (d2), s/veh	13.0	1.0	6.1	5.9	0.3	50.5	7.9	1.6	2.9	4.1	1.9	3.6
Initial Q Delay(d3), s/veh	0.0	0.0	0.0	0.0	0.0	0.0	0.0	0.0	0.0	0.0	0.0	0.0
%ile BackOfQ(95%),veh/ln	10.6	8.4	11.2	4.7	3.2	23.3	4.5	18.0	19.5	7.2	21.3	22.5
Unsig. Movement Delay, s/veh												
LnGrp Delay(d), s/veh	74.2	52.4	59.7	71.1	55.1	105.7	73.3	27.2	28.5	67.2	27.1	28.9
LnGrp LOS	E	D	E	E	E	F	E	C	C	E	C	C
Approach Vol, veh/h		679			594			1718			2125	
Approach Delay, s/veh		65.1			88.0			31.2			32.0	
Approach LOS		E			F			C			C	
Timer - Assigned Phs	1	2	3	4	5	6	7	8				
Phs Duration (G+Y+Rc), s	17.5	75.6	14.6	32.2	13.8	79.3	21.9	25.0				
Change Period (Y+Rc), s	6.0	6.5	7.0	* 7	6.5	* 6.5	6.5	7.0				
Max Green Setting (Gmax), s	22.0	55.5	11.0	* 26	9.5	* 68	18.5	18.0				
Max Q Clear Time (g_c+I1), s	11.0	32.1	7.5	18.0	7.3	40.3	15.0	20.0				
Green Ext Time (p_c), s	0.5	11.2	0.1	1.1	0.1	16.0	0.4	0.0				

Intersection Summary												
HCM 7th Control Delay, s/veh				42.6								
HCM 7th LOS				D								

Notes  
\* HCM 7th computational engine requires equal clearance times for the phases crossing the barrier.

Timings  
5: Kendrick Castillo Way & Plaza Dr

2045 Background AM  
06/10/2025



Lane Group	EBL	EBT	WBL	WBT	WBR	NBL	NBT	SBL	SBT
Lane Configurations	↔↔	↕↕	↔↔	↕↕	↕	↔↔	↕↕↕	↔↔	↕↕↕
Traffic Volume (vph)	352	243	28	156	207	294	1492	548	1225
Future Volume (vph)	352	243	28	156	207	294	1492	548	1225
Turn Type	Prot	NA	Prot	NA	pm+ov	Prot	NA	Prot	NA
Protected Phases	7	4	3	8	1	5	2	1	6
Permitted Phases					8				
Detector Phase	7	4	3	8	1	5	2	1	6
Switch Phase									
Minimum Initial (s)	5.0	5.0	5.0	5.0	5.0	5.0	5.0	5.0	5.0
Minimum Split (s)	11.5	25.0	12.0	25.0	11.0	11.5	24.5	11.0	24.0
Total Split (s)	24.0	37.0	12.0	25.0	32.0	23.0	59.0	32.0	68.0
Total Split (%)	17.1%	26.4%	8.6%	17.9%	22.9%	16.4%	42.1%	22.9%	48.6%
Yellow Time (s)	4.0	4.0	4.0	4.0	4.0	4.0	4.0	4.0	4.0
All-Red Time (s)	2.5	2.5	3.0	3.0	2.0	2.5	2.5	2.0	2.0
Lost Time Adjust (s)	0.0	0.0	0.0	0.0	0.0	0.0	0.0	0.0	0.0
Total Lost Time (s)	6.5	6.5	7.0	7.0	6.0	6.5	6.5	6.0	6.0
Lead/Lag	Lead	Lag	Lead	Lag	Lead	Lead	Lag	Lead	Lag
Lead-Lag Optimize?	Yes	Yes	Yes	Yes	Yes	Yes	Yes	Yes	Yes
Recall Mode	None	None	None	None	None	None	C-Max	None	C-Max
Act Effct Green (s)	17.4	29.5	5.0	12.2	48.9	17.9	54.7	29.6	66.4
Actuated g/C Ratio	0.12	0.21	0.04	0.09	0.35	0.13	0.39	0.21	0.47
v/c Ratio	0.91	0.61	0.25	0.57	0.37	0.74	0.90	0.85	0.73
Control Delay (s/veh)	85.8	39.9	71.0	68.3	15.4	69.5	47.8	64.9	31.5
Queue Delay	0.0	0.0	0.0	0.0	0.0	0.0	0.0	0.0	0.0
Total Delay (s/veh)	85.8	39.9	71.0	68.3	15.4	69.5	47.8	64.9	31.5
LOS	F	D	E	E	B	E	D	E	C
Approach Delay (s/veh)		60.3		40.4			51.1		40.2
Approach LOS		E		D			D		D

Intersection Summary

Cycle Length: 140  
 Actuated Cycle Length: 140  
 Offset: 0 (0%), Referenced to phase 2:NBT and 6:SBT, Start of Green  
 Natural Cycle: 130  
 Control Type: Actuated-Coordinated  
 Maximum v/c Ratio: 0.91  
 Intersection Signal Delay (s/veh): 47.3  
 Intersection LOS: D  
 Intersection Capacity Utilization 85.8%  
 ICU Level of Service E  
 Analysis Period (min) 15

Splits and Phases: 5: Kendrick Castillo Way & Plaza Dr



HCM 7th Signalized Intersection Summary  
5: Kendrick Castillo Way & Plaza Dr

2045 Background AM  
06/10/2025



Movement	EBL	EBT	EBR	WBL	WBT	WBR	NBL	NBT	NBR	SBL	SBT	SBR
Lane Configurations	↔↔	↕↕		↔↔	↕↕	↗	↔↔	↕↕↕		↔↔	↕↕↕	
Traffic Volume (veh/h)	352	243	197	28	156	207	294	1492	110	548	1225	320
Future Volume (veh/h)	352	243	197	28	156	207	294	1492	110	548	1225	320
Initial Q (Qb), veh	1	0	0	0	0	0	0	0	0	0	0	0
Lane Width Adj.	1.00	1.00	1.00	1.00	1.00	1.00	1.00	1.00	1.00	1.00	1.00	1.00
Ped-Bike Adj(A_pbT)	1.00		1.00	1.00		1.00	1.00		1.00	1.00		1.00
Parking Bus, Adj	1.00	1.00	1.00	1.00	1.00	1.00	1.00	1.00	1.00	1.00	1.00	1.00
Work Zone On Approach		No			No			No			No	
Adj Sat Flow, veh/h/ln	1900	1900	1900	1870	1870	1870	1885	1885	1885	1870	1870	1870
Adj Flow Rate, veh/h	396	273	221	31	175	233	330	1676	102	616	1376	248
Peak Hour Factor	0.89	0.89	0.89	0.89	0.89	0.89	0.89	0.89	0.89	0.89	0.89	0.89
Percent Heavy Veh, %	0	0	0	2	2	2	1	1	1	2	2	2
Cap, veh/h	439	433	339	86	457	498	379	1860	113	642	1950	351
Arrive On Green	0.13	0.22	0.22	0.03	0.13	0.13	0.11	0.38	0.38	0.19	0.45	0.45
Sat Flow, veh/h	3510	1925	1508	3456	3554	1585	3483	4960	302	3456	4350	783
Grp Volume(v), veh/h	396	255	239	31	175	233	330	1159	619	616	1077	547
Grp Sat Flow(s),veh/h/ln	1755	1805	1629	1728	1777	1585	1742	1716	1831	1728	1702	1729
Q Serve(g_s), s	15.6	17.9	18.6	1.2	6.3	16.5	13.1	44.6	44.7	24.7	35.7	35.8
Cycle Q Clear(g_c), s	15.6	17.9	18.6	1.2	6.3	16.5	13.1	44.6	44.7	24.7	35.7	35.8
Prop In Lane	1.00		0.93	1.00		1.00	1.00		0.16	1.00		0.45
Lane Grp Cap(c), veh/h	439	406	366	86	457	498	379	1287	687	642	1526	775
V/C Ratio(X)	0.90	0.63	0.65	0.36	0.38	0.47	0.87	0.90	0.90	0.96	0.71	0.71
Avail Cap(c_a), veh/h	439	406	366	123	457	498	411	1287	687	642	1526	775
HCM Platoon Ratio	1.00	1.00	1.00	1.00	1.00	1.00	1.00	1.00	1.00	1.00	1.00	1.00
Upstream Filter(I)	1.00	1.00	1.00	1.00	1.00	1.00	1.00	1.00	1.00	0.67	0.67	0.67
Uniform Delay (d), s/veh	60.5	49.0	49.3	67.1	55.9	38.6	61.4	41.3	41.3	56.5	31.2	31.2
Incr Delay (d2), s/veh	21.6	3.1	4.1	2.5	0.5	0.7	17.1	10.3	17.3	20.0	1.9	3.6
Initial Q Delay(d3), s/veh	0.4	0.0	0.0	0.0	0.0	0.0	0.0	0.0	0.0	0.0	0.0	0.0
%ile BackOfQ(95%),veh/ln	13.0	13.1	12.5	1.0	5.1	10.6	10.8	27.3	30.5	17.1	19.8	20.6
Unsig. Movement Delay, s/veh												
LnGrp Delay(d), s/veh	82.4	52.1	53.3	69.6	56.4	39.3	78.5	51.6	58.6	76.5	33.0	34.8
LnGrp LOS	F	D	D	E	E	D	E	D	E	E	C	C
Approach Vol, veh/h		890			439			2108			2240	
Approach Delay, s/veh		65.9			48.3			57.9			45.4	
Approach LOS		E			D			E			D	
Timer - Assigned Phs	1	2	3	4	5	6	7	8				
Phs Duration (G+Y+Rc), s	32.0	59.0	10.5	38.5	21.7	69.3	24.0	25.0				
Change Period (Y+Rc), s	6.0	6.5	7.0	* 7	6.5	* 6.5	6.5	7.0				
Max Green Setting (Gmax), s	26.0	52.5	5.0	* 31	16.5	* 62	17.5	18.0				
Max Q Clear Time (g_c+I1), s	26.7	46.7	3.2	20.6	15.1	37.8	17.6	18.5				
Green Ext Time (p_c), s	0.0	4.5	0.0	2.0	0.2	12.3	0.0	0.0				

Intersection Summary												
HCM 7th Control Delay, s/veh				53.5								
HCM 7th LOS				D								

Notes  
\* HCM 7th computational engine requires equal clearance times for the phases crossing the barrier.

Timings  
5: Kendrick Castillo Way & Plaza Dr

2045 Background PM  
06/09/2025



Lane Group	EBL	EBT	WBL	WBT	WBR	NBL	NBT	SBL	SBT
Lane Configurations	↔↔	↕↕	↔↔	↕↕	↕	↔↔	↕↕↕	↔↔	↕↕↕
Traffic Volume (vph)	325	153	151	106	439	117	1631	248	1783
Future Volume (vph)	325	153	151	106	439	117	1631	248	1783
Turn Type	Prot	NA	Prot	NA	pm+ov	Prot	NA	Prot	NA
Protected Phases	7	4	3	8	1	5	2	1	6
Permitted Phases					8				
Detector Phase	7	4	3	8	1	5	2	1	6
Switch Phase									
Minimum Initial (s)	5.0	5.0	5.0	5.0	5.0	5.0	5.0	5.0	5.0
Minimum Split (s)	11.5	25.0	12.0	25.0	11.0	11.5	24.5	11.0	24.0
Total Split (s)	25.0	32.0	18.0	25.0	28.0	15.0	62.0	28.0	75.0
Total Split (%)	17.9%	22.9%	12.9%	17.9%	20.0%	10.7%	44.3%	20.0%	53.6%
Yellow Time (s)	4.0	4.0	4.0	4.0	4.0	4.0	4.0	4.0	4.0
All-Red Time (s)	2.5	2.5	3.0	3.0	2.0	2.5	2.5	2.0	2.0
Lost Time Adjust (s)	0.0	0.0	0.0	0.0	0.0	0.0	0.0	0.0	0.0
Total Lost Time (s)	6.5	6.5	7.0	7.0	6.0	6.5	6.5	6.0	6.0
Lead/Lag	Lead	Lag	Lead	Lag	Lead	Lead	Lag	Lead	Lag
Lead-Lag Optimize?	Yes	Yes	Yes	Yes	Yes	Yes	Yes	Yes	Yes
Recall Mode	None	None	None	None	None	None	C-Max	None	C-Max
Act Effct Green (s)	17.6	17.5	10.5	10.3	42.3	10.2	61.2	24.9	75.9
Actuated g/C Ratio	0.13	0.13	0.08	0.07	0.30	0.07	0.44	0.18	0.54
v/c Ratio	0.81	0.73	0.64	0.44	0.83	0.51	0.83	0.44	0.79
Control Delay (s/veh)	74.7	47.7	74.3	66.5	45.4	69.2	39.9	53.1	28.9
Queue Delay	0.0	0.0	0.0	0.0	0.0	0.0	0.0	0.0	0.0
Total Delay (s/veh)	74.7	47.7	74.3	66.5	45.4	69.2	39.9	53.1	28.9
LOS	E	D	E	E	D	E	D	D	C
Approach Delay (s/veh)		60.7		54.9			41.8		31.6
Approach LOS		E		D			D		C

Intersection Summary

Cycle Length: 140  
 Actuated Cycle Length: 140  
 Offset: 0 (0%), Referenced to phase 2:NBT and 6:SBT, Start of Green  
 Natural Cycle: 100  
 Control Type: Actuated-Coordinated  
 Maximum v/c Ratio: 0.83  
 Intersection Signal Delay (s/veh): 41.6  
 Intersection LOS: D  
 Intersection Capacity Utilization 85.5%  
 ICU Level of Service E  
 Analysis Period (min) 15

Splits and Phases: 5: Kendrick Castillo Way & Plaza Dr



HCM 7th Signalized Intersection Summary  
5: Kendrick Castillo Way & Plaza Dr

2045 Background PM  
06/09/2025



Movement	EBL	EBT	EBR	WBL	WBT	WBR	NBL	NBT	NBR	SBL	SBT	SBR
Lane Configurations	↔↔	↕↕		↔↔	↕↕	↗	↔↔	↕↕↕		↔↔	↕↕↕	
Traffic Volume (veh/h)	325	153	194	151	106	439	117	1631	76	248	1783	212
Future Volume (veh/h)	325	153	194	151	106	439	117	1631	76	248	1783	212
Initial Q (Qb), veh	0	0	0	0	0	0	0	0	0	0	0	0
Lane Width Adj.	1.00	1.00	1.00	1.00	1.00	1.00	1.00	1.00	1.00	1.00	1.00	1.00
Ped-Bike Adj(A_pbT)	1.00		1.00	1.00		1.00	1.00		1.00	1.00		1.00
Parking Bus, Adj	1.00	1.00	1.00	1.00	1.00	1.00	1.00	1.00	1.00	1.00	1.00	1.00
Work Zone On Approach		No			No			No			No	
Adj Sat Flow, veh/h/ln	1900	1900	1900	1900	1900	1900	1900	1900	1900	1900	1900	1900
Adj Flow Rate, veh/h	357	168	213	166	116	416	129	1792	84	273	1959	233
Peak Hour Factor	0.91	0.91	0.91	0.91	0.91	0.91	0.91	0.91	0.91	0.91	0.91	0.91
Percent Heavy Veh, %	0	0	0	0	0	0	0	0	0	0	0	0
Cap, veh/h	409	325	290	216	464	360	177	2407	113	333	2423	285
Arrive On Green	0.12	0.18	0.18	0.06	0.13	0.13	0.05	0.47	0.47	0.09	0.52	0.52
Sat Flow, veh/h	3510	1805	1610	3510	3610	1610	3510	5078	238	3510	4704	554
Grp Volume(v), veh/h	357	168	213	166	116	416	129	1220	656	273	1435	757
Grp Sat Flow(s),veh/h/ln	1755	1805	1610	1755	1805	1610	1755	1729	1857	1755	1729	1800
Q Serve(g_s), s	14.0	11.8	17.5	6.5	4.1	18.0	5.1	40.1	40.2	10.7	48.2	49.3
Cycle Q Clear(g_c), s	14.0	11.8	17.5	6.5	4.1	18.0	5.1	40.1	40.2	10.7	48.2	49.3
Prop In Lane	1.00		1.00	1.00		1.00	1.00		0.13	1.00		0.31
Lane Grp Cap(c), veh/h	409	325	290	216	464	360	177	1639	881	333	1781	927
V/C Ratio(X)	0.87	0.52	0.73	0.77	0.25	1.16	0.73	0.74	0.75	0.82	0.81	0.82
Avail Cap(c_a), veh/h	464	329	293	276	464	360	213	1639	881	552	1781	927
HCM Platoon Ratio	1.00	1.00	1.00	1.00	1.00	1.00	1.00	1.00	1.00	1.00	1.00	1.00
Upstream Filter(I)	1.00	1.00	1.00	1.00	1.00	1.00	1.00	1.00	1.00	0.75	0.75	0.75
Uniform Delay (d), s/veh	60.8	51.9	54.2	64.7	54.9	54.4	65.5	29.9	29.9	62.2	28.1	28.4
Incr Delay (d2), s/veh	15.1	1.4	9.1	9.5	0.3	96.9	9.6	3.1	5.7	3.8	3.0	6.0
Initial Q Delay(d3), s/veh	0.0	0.0	0.0	0.0	0.0	0.0	0.0	0.0	0.0	0.0	0.0	0.0
%ile BackOfQ(95%),veh/ln	11.4	9.2	12.3	5.7	3.3	31.9	4.4	23.3	25.6	8.0	26.1	28.4
Unsig. Movement Delay, s/veh												
LnGrp Delay(d), s/veh	75.9	53.3	63.3	74.2	55.2	151.3	75.1	33.0	35.6	65.9	31.2	34.5
LnGrp LOS	E	D	E	E	E	F	E	C	D	E	C	C
Approach Vol, veh/h		738			698			2005			2465	
Approach Delay, s/veh		67.1			117.0			36.6			36.0	
Approach LOS		E			F			D			D	
Timer - Assigned Phs	1	2	3	4	5	6	7	8				
Phs Duration (G+Y+Rc), s	19.3	72.9	15.6	32.2	13.6	78.6	22.8	25.0				
Change Period (Y+Rc), s	6.0	6.5	7.0	* 7	6.5	* 6.5	6.5	7.0				
Max Green Setting (Gmax), s	22.0	55.5	11.0	* 26	8.5	* 69	18.5	18.0				
Max Q Clear Time (g_c+I1), s	12.7	42.2	8.5	19.5	7.1	51.3	16.0	20.0				
Green Ext Time (p_c), s	0.6	9.3	0.1	1.1	0.0	13.5	0.3	0.0				

Intersection Summary												
HCM 7th Control Delay, s/veh				49.7								
HCM 7th LOS				D								

Notes  
\* HCM 7th computational engine requires equal clearance times for the phases crossing the barrier.

Timings  
5: Kendrick Castillo Way & Plaza Dr

2045 Total AM  
02/05/2026



Lane Group	EBL	EBT	WBL	WBT	WBR	NBL	NBT	SBL	SBT
Lane Configurations	↔↔	↕↕	↔↔	↕↕	↕	↔↔	↕↕↕	↔↔	↕↕↕
Traffic Volume (vph)	389	254	28	159	207	301	1492	548	1225
Future Volume (vph)	389	254	28	159	207	301	1492	548	1225
Turn Type	Prot	NA	Prot	NA	pm+ov	Prot	NA	Prot	NA
Protected Phases	7	4	3	8	1	5	2	1	6
Permitted Phases					8				
Detector Phase	7	4	3	8	1	5	2	1	6
Switch Phase									
Minimum Initial (s)	5.0	5.0	5.0	5.0	5.0	5.0	5.0	5.0	5.0
Minimum Split (s)	11.5	25.0	12.0	25.0	11.0	11.5	24.5	11.0	24.0
Total Split (s)	33.0	35.0	20.0	22.0	31.0	24.0	54.0	31.0	61.0
Total Split (%)	23.6%	25.0%	14.3%	15.7%	22.1%	17.1%	38.6%	22.1%	43.6%
Yellow Time (s)	4.0	4.0	4.0	4.0	4.0	4.0	4.0	4.0	4.0
All-Red Time (s)	2.5	2.5	3.0	3.0	2.0	2.5	2.5	2.0	2.0
Lost Time Adjust (s)	0.0	0.0	0.0	0.0	0.0	0.0	0.0	0.0	0.0
Total Lost Time (s)	6.5	6.5	7.0	7.0	6.0	6.5	6.5	6.0	6.0
Lead/Lag	Lead	Lag	Lead	Lag	Lead	Lead	Lag	Lead	Lag
Lead-Lag Optimize?	Yes	Yes	Yes	Yes	Yes	Yes	Yes	Yes	Yes
Recall Mode	None	None	None	None	None	None	C-Max	None	C-Max

Intersection Summary

Cycle Length: 140  
 Actuated Cycle Length: 140  
 Offset: 0 (0%), Referenced to phase 2:NBT and 6:SBT, Start of Green  
 Natural Cycle: 130  
 Control Type: Actuated-Coordinated

Splits and Phases: 5: Kendrick Castillo Way & Plaza Dr



HCM 7th Signalized Intersection Summary  
 5: Kendrick Castillo Way & Plaza Dr

2045 Total AM  
 02/05/2026



Movement	EBL	EBT	EBR	WBL	WBT	WBR	NBL	NBT	NBR	SBL	SBT	SBR
Lane Configurations	↔↔	↑↓		↔↔	↑↑	↔	↔↔	↑↑↓		↔↔	↑↑↓	
Traffic Volume (veh/h)	389	254	218	28	159	207	301	1492	110	548	1225	332
Future Volume (veh/h)	389	254	218	28	159	207	301	1492	110	548	1225	332
Initial Q (Qb), veh	0	0	0	0	0	0	0	0	0	0	0	0
Lane Width Adj.	1.00	1.00	1.00	1.00	1.00	1.00	1.00	1.00	1.00	1.00	1.00	1.00
Ped-Bike Adj(A_pbT)	1.00		1.00	1.00		1.00	1.00		1.00	1.00		1.00
Parking Bus, Adj	1.00	1.00	1.00	1.00	1.00	1.00	1.00	1.00	1.00	1.00	1.00	1.00
Work Zone On Approach		No			No			No			No	
Adj Sat Flow, veh/h/ln	1900	1900	1900	1870	1870	1870	1885	1885	1885	1870	1870	1870
Adj Flow Rate, veh/h	437	285	245	31	179	233	338	1676	124	616	1376	261
Peak Hour Factor	0.89	0.89	0.89	0.89	0.89	0.89	0.89	0.89	0.89	0.89	0.89	0.89
Percent Heavy Veh, %	0	0	0	2	2	2	1	1	1	2	2	2
Cap, veh/h	502	414	345	86	381	453	389	1885	139	617	1935	367
Arrive On Green	0.14	0.22	0.22	0.03	0.11	0.11	0.11	0.39	0.39	0.18	0.45	0.45
Sat Flow, veh/h	3510	1867	1558	3456	3554	1585	3483	4890	361	3456	4311	817
Grp Volume(v), veh/h	437	275	255	31	179	233	338	1175	625	616	1086	551
Grp Sat Flow(s),veh/h/ln	1755	1805	1620	1728	1777	1585	1742	1716	1820	1728	1702	1723
Q Serve(g_s), s	17.1	19.6	20.3	1.2	6.6	15.0	13.4	44.8	45.0	24.9	36.2	36.2
Cycle Q Clear(g_c), s	17.1	19.6	20.3	1.2	6.6	15.0	13.4	44.8	45.0	24.9	36.2	36.2
Prop In Lane	1.00		0.96	1.00		1.00	1.00		0.20	1.00		0.47
Lane Grp Cap(c), veh/h	502	400	359	86	381	453	389	1323	702	617	1528	774
V/C Ratio(X)	0.87	0.69	0.71	0.36	0.47	0.51	0.87	0.89	0.89	1.00	0.71	0.71
Avail Cap(c_a), veh/h	664	400	359	321	381	453	435	1323	702	617	1528	774
HCM Platoon Ratio	1.00	1.00	1.00	1.00	1.00	1.00	1.00	1.00	1.00	1.00	1.00	1.00
Upstream Filter(I)	0.79	0.79	0.79	1.00	1.00	1.00	1.00	1.00	1.00	0.67	0.67	0.67
Uniform Delay (d), s/veh	58.7	50.0	50.3	67.1	58.8	41.9	61.2	40.2	40.2	57.5	31.2	31.2
Incr Delay (d2), s/veh	7.8	3.9	5.1	2.5	0.9	1.0	15.8	9.2	15.8	29.2	1.9	3.7
Initial Q Delay(d3), s/veh	0.0	0.0	0.0	0.0	0.0	0.0	0.0	0.0	0.0	0.0	0.0	0.0
%ile BackOfQ(95%),veh/ln	12.2	13.6	12.9	1.0	5.4	11.1	10.9	27.2	30.2	18.1	20.0	20.7
Unsig. Movement Delay, s/veh												
LnGrp Delay(d), s/veh	66.5	53.9	55.4	69.6	59.7	42.9	76.9	49.4	56.0	86.7	33.1	35.0
LnGrp LOS	E	D	E	E	E	D	E	D	E	F	C	C
Approach Vol, veh/h		967			443			2138			2253	
Approach Delay, s/veh		60.0			51.5			55.7			48.2	
Approach LOS		E			D			E			D	
Timer - Assigned Phs	1	2	3	4	5	6	7	8				
Phs Duration (G+Y+Rc), s	31.0	60.5	10.5	38.0	22.1	69.3	26.5	22.0				
Change Period (Y+Rc), s	6.0	6.5	7.0	* 7	6.5	* 6.5	6.5	7.0				
Max Green Setting (Gmax), s	25.0	47.5	13.0	* 29	17.5	* 55	26.5	15.0				
Max Q Clear Time (g_c+I1), s	26.9	47.0	3.2	22.3	15.4	38.2	19.1	17.0				
Green Ext Time (p_c), s	0.0	0.5	0.0	1.6	0.3	10.0	1.0	0.0				

Intersection Summary												
HCM 7th Control Delay, s/veh				53.2								
HCM 7th LOS				D								

Notes  
 User approved pedestrian interval to be less than phase max green.  
 \* HCM 7th computational engine requires equal clearance times for the phases crossing the barrier.

Timings  
5: Kendrick Castillo Way & Plaza Dr

2045 Total PM  
02/05/2026



Lane Group	EBL	EBT	WBL	WBT	WBR	NBL	NBT	SBL	SBT
Lane Configurations	↔↔	↕↕	↔↔	↕↕	↕	↔↔	↕↕↕	↔↔	↕↕↕
Traffic Volume (vph)	349	160	151	117	439	138	1631	248	1783
Future Volume (vph)	349	160	151	117	439	138	1631	248	1783
Turn Type	Prot	NA	Prot	NA	pm+ov	Prot	NA	Prot	NA
Protected Phases	7	4	3	8	1	5	2	1	6
Permitted Phases					8				
Detector Phase	7	4	3	8	1	5	2	1	6
Switch Phase									
Minimum Initial (s)	5.0	5.0	5.0	5.0	5.0	5.0	5.0	5.0	5.0
Minimum Split (s)	11.5	25.0	12.0	25.0	11.0	11.5	24.5	11.0	24.0
Total Split (s)	25.0	32.0	18.0	25.0	28.0	16.0	62.0	28.0	74.0
Total Split (%)	17.9%	22.9%	12.9%	17.9%	20.0%	11.4%	44.3%	20.0%	52.9%
Yellow Time (s)	4.0	4.0	4.0	4.0	4.0	4.0	4.0	4.0	4.0
All-Red Time (s)	2.5	2.5	3.0	3.0	2.0	2.5	2.5	2.0	2.0
Lost Time Adjust (s)	0.0	0.0	0.0	0.0	0.0	0.0	0.0	0.0	0.0
Total Lost Time (s)	6.5	6.5	7.0	7.0	6.0	6.5	6.5	6.0	6.0
Lead/Lag	Lead	Lag	Lead	Lag	Lead	Lead	Lag	Lead	Lag
Lead-Lag Optimize?	Yes	Yes	Yes	Yes	Yes	Yes	Yes	Yes	Yes
Recall Mode	None	None	None	None	None	None	C-Max	None	C-Max

Intersection Summary

Cycle Length: 140  
 Actuated Cycle Length: 140  
 Offset: 0 (0%), Referenced to phase 2:NBT and 6:SBT, Start of Green  
 Natural Cycle: 110  
 Control Type: Actuated-Coordinated

Splits and Phases: 5: Kendrick Castillo Way & Plaza Dr



HCM 7th Signalized Intersection Summary  
5: Kendrick Castillo Way & Plaza Dr

2045 Total PM  
02/05/2026



Movement	EBL	EBT	EBR	WBL	WBT	WBR	NBL	NBT	NBR	SBL	SBT	SBR
Lane Configurations	↔↔	↕↕		↔↔	↕↕	↗	↔↔	↕↕↕		↔↔	↕↕↕	
Traffic Volume (veh/h)	349	160	208	151	117	439	138	1631	76	248	1783	249
Future Volume (veh/h)	349	160	208	151	117	439	138	1631	76	248	1783	249
Initial Q (Qb), veh	0	0	0	0	0	0	0	0	0	0	0	0
Lane Width Adj.	1.00	1.00	1.00	1.00	1.00	1.00	1.00	1.00	1.00	1.00	1.00	1.00
Ped-Bike Adj(A_pbT)	1.00		1.00	1.00		1.00	1.00		1.00	1.00		1.00
Parking Bus, Adj	1.00	1.00	1.00	1.00	1.00	1.00	1.00	1.00	1.00	1.00	1.00	1.00
Work Zone On Approach		No			No			No			No	
Adj Sat Flow, veh/h/ln	1900	1900	1900	1900	1900	1900	1900	1900	1900	1900	1900	1900
Adj Flow Rate, veh/h	384	176	229	166	129	416	152	1792	84	273	1959	274
Peak Hour Factor	0.91	0.91	0.91	0.91	0.91	0.91	0.91	0.91	0.91	0.91	0.91	0.91
Percent Heavy Veh, %	0	0	0	0	0	0	0	0	0	0	0	0
Cap, veh/h	434	337	301	216	464	360	201	2372	111	333	2310	319
Arrive On Green	0.12	0.19	0.19	0.06	0.13	0.13	0.06	0.47	0.47	0.09	0.50	0.50
Sat Flow, veh/h	3510	1805	1610	3510	3610	1610	3510	5078	238	3510	4607	636
Grp Volume(v), veh/h	384	176	229	166	129	416	152	1220	656	273	1464	769
Grp Sat Flow(s),veh/h/ln	1755	1805	1610	1755	1805	1610	1755	1729	1857	1755	1729	1785
Q Serve(g_s), s	15.1	12.3	18.9	6.5	4.5	18.0	6.0	40.6	40.8	10.7	51.3	52.8
Cycle Q Clear(g_c), s	15.1	12.3	18.9	6.5	4.5	18.0	6.0	40.6	40.8	10.7	51.3	52.8
Prop In Lane	1.00		1.00	1.00		1.00	1.00		0.13	1.00		0.36
Lane Grp Cap(c), veh/h	434	337	301	216	464	360	201	1616	868	333	1734	895
V/C Ratio(X)	0.89	0.52	0.76	0.77	0.28	1.16	0.76	0.75	0.76	0.82	0.84	0.86
Avail Cap(c_a), veh/h	464	337	301	276	464	360	238	1616	868	552	1734	895
HCM Platoon Ratio	1.00	1.00	1.00	1.00	1.00	1.00	1.00	1.00	1.00	1.00	1.00	1.00
Upstream Filter(I)	0.99	0.99	0.99	1.00	1.00	1.00	1.00	1.00	1.00	0.74	0.74	0.74
Uniform Delay (d), s/veh	60.4	51.3	53.9	64.7	55.1	54.4	65.0	30.7	30.7	62.2	30.2	30.6
Incr Delay (d2), s/veh	17.4	1.4	10.7	9.5	0.3	96.9	10.9	3.3	6.1	3.7	3.9	8.0
Initial Q Delay(d3), s/veh	0.0	0.0	0.0	0.0	0.0	0.0	0.0	0.0	0.0	0.0	0.0	0.0
%ile BackOfQ(95%),veh/ln	12.2	9.5	13.2	5.7	3.7	31.9	5.3	23.7	26.0	8.0	27.9	30.6
Unsig. Movement Delay, s/veh												
LnGrp Delay(d), s/veh	77.7	52.7	64.6	74.2	55.4	151.3	76.0	34.0	36.8	65.9	34.1	38.6
LnGrp LOS	E	D	E	E	E	F	E	C	D	E	C	D
Approach Vol, veh/h		789			711			2028			2506	
Approach Delay, s/veh		68.4			115.9			38.1			39.0	
Approach LOS		E			F			D			D	
Timer - Assigned Phs	1	2	3	4	5	6	7	8				
Phs Duration (G+Y+Rc), s	19.3	71.9	15.6	33.2	14.5	76.7	23.8	25.0				
Change Period (Y+Rc), s	6.0	6.5	7.0	* 7	6.5	* 6.5	6.5	7.0				
Max Green Setting (Gmax), s	22.0	55.5	11.0	* 26	9.5	* 68	18.5	18.0				
Max Q Clear Time (g_c+I1), s	12.7	42.8	8.5	20.9	8.0	54.8	17.1	20.0				
Green Ext Time (p_c), s	0.6	9.0	0.1	1.0	0.1	10.7	0.2	0.0				

Intersection Summary												
HCM 7th Control Delay, s/veh				51.6								
HCM 7th LOS				D								

Notes  
\* HCM 7th computational engine requires equal clearance times for the phases crossing the barrier.

Timings  
6: Kendrick Castillo Way & C-470 EB Off-Ramp/C-470 EB On-Ramp

2025 Existing AM  
06/09/2025

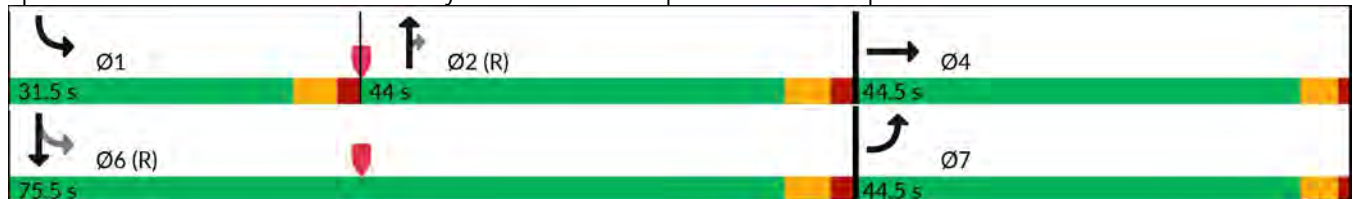


Lane Group	EBL	EBT	EBR	NBT	NBR	SBL	SBT
Lane Configurations	↶	↷	↶	↑↑↑	↶	↶	↑↑
Traffic Volume (vph)	149	0	984	1190	594	42	757
Future Volume (vph)	149	0	984	1190	594	42	757
Turn Type	Prot	NA	Free	NA	Perm	pm+pt	NA
Protected Phases	7	4		2		1	6
Permitted Phases			Free		2	6	
Detector Phase	7	4		2	2	1	6
Switch Phase							
Minimum Initial (s)	5.0	5.0		5.0	5.0	5.0	5.0
Minimum Split (s)	9.5	22.5		24.0	24.0	11.0	24.0
Total Split (s)	44.5	44.5		44.0	44.0	31.5	75.5
Total Split (%)	37.1%	37.1%		36.7%	36.7%	26.3%	62.9%
Yellow Time (s)	3.5	3.5		4.0	4.0	4.0	4.0
All-Red Time (s)	1.0	1.0		2.0	2.0	2.0	2.0
Lost Time Adjust (s)	0.0	0.0		0.0	0.0	0.0	0.0
Total Lost Time (s)	4.5	4.5		6.0	6.0	6.0	6.0
Lead/Lag				Lag	Lag	Lead	
Lead-Lag Optimize?				Yes	Yes	Yes	
Recall Mode	None	None		C-Max	C-Max	None	C-Max
Act Effct Green (s)	33.3	32.0	120.0	69.1	69.1	78.4	79.6
Actuated g/C Ratio	0.28	0.27	1.00	0.58	0.58	0.65	0.66
v/c Ratio	0.17	0.18	0.68	0.44	0.55	0.18	0.35
Control Delay (s/veh)	30.4	29.4	2.3	17.1	11.8	23.8	25.8
Queue Delay	0.0	0.0	0.0	0.0	0.0	0.0	0.0
Total Delay (s/veh)	30.4	29.4	2.3	17.1	11.8	23.8	25.8
LOS	C	C	A	B	B	C	C
Approach Delay (s/veh)		5.9		15.3			25.7
Approach LOS		A		B			C

Intersection Summary

Cycle Length: 120  
 Actuated Cycle Length: 120  
 Offset: 0 (0%), Referenced to phase 2:NBT and 6:SBTL, Start of Green  
 Natural Cycle: 60  
 Control Type: Actuated-Coordinated  
 Maximum v/c Ratio: 0.68  
 Intersection Signal Delay (s/veh): 14.7  
 Intersection Capacity Utilization 58.9%  
 Analysis Period (min) 15  
 Intersection LOS: B  
 ICU Level of Service B

Splits and Phases: 6: Kendrick Castillo Way & C-470 EB Off-Ramp/C-470 EB On-Ramp



HCM 7th Signalized Intersection Summary  
 6: Kendrick Castillo Way & C-470 EB Off-Ramp/C-470 EB On-Ramp

2025 Existing AM  
 06/09/2025



Movement	EBL	EBT	EBR	WBL	WBT	WBR	NBL	NBT	NBR	SBL	SBT	SBR
Lane Configurations	↗	↘	↖					↑↑↑	↗	↘	↑↑	
Traffic Volume (veh/h)	149	0	984	0	0	0	0	1190	594	42	757	0
Future Volume (veh/h)	149	0	984	0	0	0	0	1190	594	42	757	0
Initial Q (Qb), veh	0	0	0				0	0	0	0	0	0
Lane Width Adj.	1.00	1.00	1.00				1.00	1.00	1.00	1.00	1.00	1.00
Ped-Bike Adj(A_pbT)	1.00		1.00				1.00		1.00	1.00		1.00
Parking Bus, Adj	1.00	1.00	1.00				1.00	1.00	1.00	1.00	1.00	1.00
Work Zone On Approach		No						No			No	
Adj Sat Flow, veh/h/ln	1885	1885	1885				0	1885	1885	1870	1870	0
Adj Flow Rate, veh/h	164	0	0				0	1308	0	46	832	0
Peak Hour Factor	0.91	0.91	0.91				0.91	0.91	0.91	0.91	0.91	0.91
Percent Heavy Veh, %	1	1	1				0	1	1	2	2	0
Cap, veh/h	236	0					0	3933		377	3010	0
Arrive On Green	0.07	0.00	0.00				0.00	0.51	0.00	0.07	1.00	0.00
Sat Flow, veh/h	3591	0	1598				0	5316	1598	1781	3647	0
Grp Volume(v), veh/h	164	0	0				0	1308	0	46	832	0
Grp Sat Flow(s),veh/h/ln	1795	0	1598				0	1716	1598	1781	1777	0
Q Serve(g_s), s	5.4	0.0	0.0				0.0	17.9	0.0	0.6	0.0	0.0
Cycle Q Clear(g_c), s	5.4	0.0	0.0				0.0	17.9	0.0	0.6	0.0	0.0
Prop In Lane	1.00		1.00				0.00		1.00	1.00		0.00
Lane Grp Cap(c), veh/h	236	0					0	3933		377	3010	0
V/C Ratio(X)	0.70	0.00					0.00	0.33		0.12	0.28	0.00
Avail Cap(c_a), veh/h	1197	0					0	3933		697	3010	0
HCM Platoon Ratio	1.00	1.00	1.00				1.00	0.67	0.67	2.00	2.00	1.00
Upstream Filter(I)	1.00	0.00	0.00				0.00	0.66	0.00	0.88	0.88	0.00
Uniform Delay (d), s/veh	54.9	0.0	0.0				0.0	11.3	0.0	3.9	0.0	0.0
Incr Delay (d2), s/veh	3.7	0.0	0.0				0.0	0.2	0.0	0.1	0.2	0.0
Initial Q Delay(d3), s/veh	0.0	0.0	0.0				0.0	0.0	0.0	0.0	0.0	0.0
%ile BackOfQ(95%),veh/ln	4.6	0.0	0.0				0.0	11.1	0.0	0.3	0.2	0.0
Unsig. Movement Delay, s/veh												
LnGrp Delay(d), s/veh	58.6	0.0	0.0				0.0	11.4	0.0	4.0	0.2	0.0
LnGrp LOS	E							B		A	A	
Approach Vol, veh/h		164						1308			878	
Approach Delay, s/veh		58.6						11.4			0.4	
Approach LOS		E						B			A	
Timer - Assigned Phs	1	2		4				6				
Phs Duration (G+Y+Rc), s	9.9	97.7		12.4				107.6				
Change Period (Y+Rc), s	6.0	6.0		4.5				6.0				
Max Green Setting (Gmax), s	25.5	38.0		40.0				69.5				
Max Q Clear Time (g_c+I1), s	2.6	19.9		7.4				2.0				
Green Ext Time (p_c), s	0.1	8.5		0.5				6.6				

Intersection Summary												
HCM 7th Control Delay, s/veh			10.6									
HCM 7th LOS			B									

Notes  
 User approved volume balancing among the lanes for turning movement.  
 Unsignalized Delay for [NBR, EBR] is excluded from calculations of the approach delay and intersection delay.



HCM 7th Signalized Intersection Summary  
 6: Kendrick Castillo Way & C-470 EB Off-Ramp/C-470 EB On-Ramp

2025 Existing PM  
 06/09/2025



Movement	EBL	EBT	EBR	WBL	WBT	WBR	NBL	NBT	NBR	SBL	SBT	SBR
Lane Configurations	↘	↙	↗					↑↑↑	↗	↘	↑↑	
Traffic Volume (veh/h)	73	0	877	0	0	0	0	1175	686	110	906	0
Future Volume (veh/h)	73	0	877	0	0	0	0	1175	686	110	906	0
Initial Q (Qb), veh	0	0	0				0	0	0	0	0	0
Lane Width Adj.	1.00	1.00	1.00				1.00	1.00	1.00	1.00	1.00	1.00
Ped-Bike Adj(A_pbT)	1.00		1.00				1.00		1.00	1.00		1.00
Parking Bus, Adj	1.00	1.00	1.00				1.00	1.00	1.00	1.00	1.00	1.00
Work Zone On Approach		No						No			No	
Adj Sat Flow, veh/h/ln	1900	1900	1900				0	1900	1900	1900	1900	0
Adj Flow Rate, veh/h	79	0	0				0	1277	0	120	985	0
Peak Hour Factor	0.92	0.92	0.92				0.92	0.92	0.92	0.92	0.92	0.92
Percent Heavy Veh, %	0	0	0				0	0	0	0	0	0
Cap, veh/h	140	0					0	4061		447	3155	0
Arrive On Green	0.04	0.00	0.00				0.00	0.78	0.00	0.08	1.00	0.00
Sat Flow, veh/h	3619	0	1610				0	5358	1610	1810	3705	0
Grp Volume(v), veh/h	79	0	0				0	1277	0	120	985	0
Grp Sat Flow(s),veh/h/ln	1810	0	1610				0	1729	1610	1810	1805	0
Q Serve(g_s), s	2.6	0.0	0.0				0.0	8.5	0.0	1.4	0.0	0.0
Cycle Q Clear(g_c), s	2.6	0.0	0.0				0.0	8.5	0.0	1.4	0.0	0.0
Prop In Lane	1.00		1.00				0.00		1.00	1.00		0.00
Lane Grp Cap(c), veh/h	140	0					0	4061		447	3155	0
V/C Ratio(X)	0.56	0.00					0.00	0.31		0.27	0.31	0.00
Avail Cap(c_a), veh/h	1206	0					0	4061		758	3155	0
HCM Platoon Ratio	1.00	1.00	1.00				1.00	1.00	1.00	2.00	2.00	1.00
Upstream Filter(I)	1.00	0.00	0.00				0.00	0.72	0.00	0.81	0.81	0.00
Uniform Delay (d), s/veh	56.7	0.0	0.0				0.0	3.8	0.0	2.2	0.0	0.0
Incr Delay (d2), s/veh	3.5	0.0	0.0				0.0	0.1	0.0	0.3	0.2	0.0
Initial Q Delay(d3), s/veh	0.0	0.0	0.0				0.0	0.0	0.0	0.0	0.0	0.0
%ile BackOfQ(95%),veh/ln	2.2	0.0	0.0				0.0	4.1	0.0	0.5	0.2	0.0
Unsig. Movement Delay, s/veh												
LnGrp Delay(d), s/veh	60.2	0.0	0.0				0.0	3.9	0.0	2.4	0.2	0.0
LnGrp LOS	E							A		A	A	
Approach Vol, veh/h		79						1277			1105	
Approach Delay, s/veh		60.2						3.9			0.4	
Approach LOS		E						A			A	
Timer - Assigned Phs	1	2		4				6				
Phs Duration (G+Y+Rc), s	10.9	100.0		9.1				110.9				
Change Period (Y+Rc), s	6.0	6.0		4.5				6.0				
Max Green Setting (Gmax), s	25.5	38.0		40.0				69.5				
Max Q Clear Time (g_c+I1), s	3.4	10.5		4.6				2.0				
Green Ext Time (p_c), s	0.3	10.1		0.2				8.4				

Intersection Summary												
HCM 7th Control Delay, s/veh			4.2									
HCM 7th LOS			A									

Notes  
 User approved volume balancing among the lanes for turning movement.  
 Unsignalized Delay for [NBR, EBR] is excluded from calculations of the approach delay and intersection delay.



HCM 7th Signalized Intersection Summary  
 6: Kendrick Castillo Way & C-470 EB Off-Ramp/C-470 EB On-Ramp

2028 Background AM  
 06/09/2025



Movement	EBL	EBT	EBR	WBL	WBT	WBR	NBL	NBT	NBR	SBL	SBT	SBR
Lane Configurations	↘	↙	↗					↑↑↑	↗	↘	↑↑	
Traffic Volume (veh/h)	154	0	1017	0	0	0	0	1226	612	43	785	0
Future Volume (veh/h)	154	0	1017	0	0	0	0	1226	612	43	785	0
Initial Q (Qb), veh	0	0	0				0	0	0	0	0	0
Lane Width Adj.	1.00	1.00	1.00				1.00	1.00	1.00	1.00	1.00	1.00
Ped-Bike Adj(A_pbT)	1.00		1.00				1.00		1.00	1.00		1.00
Parking Bus, Adj	1.00	1.00	1.00				1.00	1.00	1.00	1.00	1.00	1.00
Work Zone On Approach		No						No			No	
Adj Sat Flow, veh/h/ln	1885	1885	1885				0	1885	1885	1870	1870	0
Adj Flow Rate, veh/h	169	0	0				0	1347	0	47	863	0
Peak Hour Factor	0.91	0.91	0.91				0.91	0.91	0.91	0.91	0.91	0.91
Percent Heavy Veh, %	1	1	1				0	1	1	2	2	0
Cap, veh/h	241	0					0	3924		365	3004	0
Arrive On Green	0.07	0.00	0.00				0.00	0.51	0.00	0.07	1.00	0.00
Sat Flow, veh/h	3591	0	1598				0	5316	1598	1781	3647	0
Grp Volume(v), veh/h	169	0	0				0	1347	0	47	863	0
Grp Sat Flow(s),veh/h/ln	1795	0	1598				0	1716	1598	1781	1777	0
Q Serve(g_s), s	5.5	0.0	0.0				0.0	18.6	0.0	0.6	0.0	0.0
Cycle Q Clear(g_c), s	5.5	0.0	0.0				0.0	18.6	0.0	0.6	0.0	0.0
Prop In Lane	1.00		1.00				0.00		1.00	1.00		0.00
Lane Grp Cap(c), veh/h	241	0					0	3924		365	3004	0
V/C Ratio(X)	0.70	0.00					0.00	0.34		0.13	0.29	0.00
Avail Cap(c_a), veh/h	1197	0					0	3924		685	3004	0
HCM Platoon Ratio	1.00	1.00	1.00				1.00	0.67	0.67	2.00	2.00	1.00
Upstream Filter(I)	1.00	0.00	0.00				0.00	0.59	0.00	0.86	0.86	0.00
Uniform Delay (d), s/veh	54.8	0.0	0.0				0.0	11.5	0.0	4.0	0.0	0.0
Incr Delay (d2), s/veh	3.7	0.0	0.0				0.0	0.1	0.0	0.1	0.2	0.0
Initial Q Delay(d3), s/veh	0.0	0.0	0.0				0.0	0.0	0.0	0.0	0.0	0.0
%ile BackOfQ(95%),veh/ln	4.7	0.0	0.0				0.0	11.2	0.0	0.3	0.2	0.0
Unsig. Movement Delay, s/veh												
LnGrp Delay(d), s/veh	58.5	0.0	0.0				0.0	11.7	0.0	4.2	0.2	0.0
LnGrp LOS	E							B		A	A	
Approach Vol, veh/h		169						1347			910	
Approach Delay, s/veh		58.5						11.7			0.4	
Approach LOS		E						B			A	
Timer - Assigned Phs	1	2		4				6				
Phs Duration (G+Y+Rc), s	10.0	97.5		12.6				107.4				
Change Period (Y+Rc), s	6.0	6.0		4.5				6.0				
Max Green Setting (Gmax), s	25.5	38.0		40.0				69.5				
Max Q Clear Time (g_c+I1), s	2.6	20.6		7.5				2.0				
Green Ext Time (p_c), s	0.1	8.6		0.6				6.9				

Intersection Summary

HCM 7th Control Delay, s/veh	10.7
HCM 7th LOS	B

Notes

User approved volume balancing among the lanes for turning movement.  
 Unsignalized Delay for [NBR, EBR] is excluded from calculations of the approach delay and intersection delay.



HCM 7th Signalized Intersection Summary  
 6: Kendrick Castillo Way & C-470 EB Off-Ramp/C-470 EB On-Ramp

2028 Background PM  
 06/10/2025



Movement	EBL	EBT	EBR	WBL	WBT	WBR	NBL	NBT	NBR	SBL	SBT	SBR
Lane Configurations	↘	↙	↗					↑↑↑	↗	↘	↑↑	
Traffic Volume (veh/h)	75	0	912	0	0	0	0	1211	707	113	945	0
Future Volume (veh/h)	75	0	912	0	0	0	0	1211	707	113	945	0
Initial Q (Qb), veh	0	0	0				0	0	0	0	0	0
Lane Width Adj.	1.00	1.00	1.00				1.00	1.00	1.00	1.00	1.00	1.00
Ped-Bike Adj(A_pbT)	1.00		1.00				1.00		1.00	1.00		1.00
Parking Bus, Adj	1.00	1.00	1.00				1.00	1.00	1.00	1.00	1.00	1.00
Work Zone On Approach		No						No			No	
Adj Sat Flow, veh/h/ln	1900	1900	1900				0	1900	1900	1900	1900	0
Adj Flow Rate, veh/h	82	0	0				0	1316	0	123	1027	0
Peak Hour Factor	0.92	0.92	0.92				0.92	0.92	0.92	0.92	0.92	0.92
Percent Heavy Veh, %	0	0	0				0	0	0	0	0	0
Cap, veh/h	141	0					0	4059		435	3153	0
Arrive On Green	0.04	0.00	0.00				0.00	0.78	0.00	0.08	1.00	0.00
Sat Flow, veh/h	3619	0	1610				0	5358	1610	1810	3705	0
Grp Volume(v), veh/h	82	0	0				0	1316	0	123	1027	0
Grp Sat Flow(s),veh/h/ln	1810	0	1610				0	1729	1610	1810	1805	0
Q Serve(g_s), s	2.7	0.0	0.0				0.0	8.9	0.0	1.4	0.0	0.0
Cycle Q Clear(g_c), s	2.7	0.0	0.0				0.0	8.9	0.0	1.4	0.0	0.0
Prop In Lane	1.00		1.00				0.00		1.00	1.00		0.00
Lane Grp Cap(c), veh/h	141	0					0	4059		435	3153	0
V/C Ratio(X)	0.58	0.00					0.00	0.32		0.28	0.33	0.00
Avail Cap(c_a), veh/h	1206	0					0	4059		745	3153	0
HCM Platoon Ratio	1.00	1.00	1.00				1.00	1.00	1.00	2.00	2.00	1.00
Upstream Filter(I)	1.00	0.00	0.00				0.00	0.68	0.00	0.79	0.79	0.00
Uniform Delay (d), s/veh	56.7	0.0	0.0				0.0	3.8	0.0	2.2	0.0	0.0
Incr Delay (d2), s/veh	3.8	0.0	0.0				0.0	0.1	0.0	0.3	0.2	0.0
Initial Q Delay(d3), s/veh	0.0	0.0	0.0				0.0	0.0	0.0	0.0	0.0	0.0
%ile BackOfQ(95%),veh/ln	2.3	0.0	0.0				0.0	4.2	0.0	0.5	0.2	0.0
Unsig. Movement Delay, s/veh												
LnGrp Delay(d), s/veh	60.5	0.0	0.0				0.0	3.9	0.0	2.5	0.2	0.0
LnGrp LOS	E							A		A	A	
Approach Vol, veh/h		82						1316			1150	
Approach Delay, s/veh		60.5						3.9			0.5	
Approach LOS		E						A			A	
Timer - Assigned Phs	1	2		4				6				
Phs Duration (G+Y+Rc), s	10.9	99.9		9.2				110.8				
Change Period (Y+Rc), s	6.0	6.0		4.5				6.0				
Max Green Setting (Gmax), s	25.5	38.0		40.0				69.5				
Max Q Clear Time (g_c+I1), s	3.4	10.9		4.7				2.0				
Green Ext Time (p_c), s	0.3	10.4		0.2				8.9				

Intersection Summary												
HCM 7th Control Delay, s/veh			4.2									
HCM 7th LOS			A									

Notes  
 User approved volume balancing among the lanes for turning movement.  
 Unsignalized Delay for [NBR, EBR] is excluded from calculations of the approach delay and intersection delay.

Timings  
 6: Kendrick Castillo Way & C-470 EB Off-Ramp/C-470 EB On-Ramp

2028 Total AM  
 02/05/2026

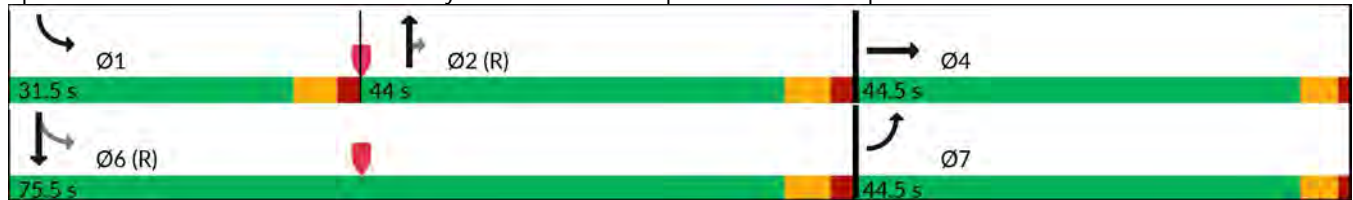


Lane Group	EBL	EBT	EBR	NBT	NBR	SBL	SBT
Lane Configurations	↶	↷	↶	↑↑↑	↶	↶	↑↑
Traffic Volume (vph)	154	0	1022	1247	628	43	792
Future Volume (vph)	154	0	1022	1247	628	43	792
Turn Type	Prot	NA	Free	NA	Perm	pm+pt	NA
Protected Phases	7	4		2		1	6
Permitted Phases			Free		2	6	
Detector Phase	7	4		2	2	1	6
Switch Phase							
Minimum Initial (s)	5.0	5.0		5.0	5.0	5.0	5.0
Minimum Split (s)	9.5	22.5		24.0	24.0	11.0	24.0
Total Split (s)	44.5	44.5		44.0	44.0	31.5	75.5
Total Split (%)	37.1%	37.1%		36.7%	36.7%	26.3%	62.9%
Yellow Time (s)	3.5	3.5		4.0	4.0	4.0	4.0
All-Red Time (s)	1.0	1.0		2.0	2.0	2.0	2.0
Lost Time Adjust (s)	0.0	0.0		0.0	0.0	0.0	0.0
Total Lost Time (s)	4.5	4.5		6.0	6.0	6.0	6.0
Lead/Lag				Lag	Lag	Lead	
Lead-Lag Optimize?				Yes	Yes	Yes	
Recall Mode	None	None		C-Max	C-Max	None	C-Max

Intersection Summary

Cycle Length: 120  
 Actuated Cycle Length: 120  
 Offset: 0 (0%), Referenced to phase 2:NBT and 6:SBTL, Start of Green  
 Natural Cycle: 60  
 Control Type: Actuated-Coordinated

Splits and Phases: 6: Kendrick Castillo Way & C-470 EB Off-Ramp/C-470 EB On-Ramp



HCM 7th Signalized Intersection Summary  
 6: Kendrick Castillo Way & C-470 EB Off-Ramp/C-470 EB On-Ramp

2028 Total AM  
 02/05/2026



Movement	EBL	EBT	EBR	WBL	WBT	WBR	NBL	NBT	NBR	SBL	SBT	SBR
Lane Configurations	↗	↘	↖					↑↑↑	↗	↘	↑↑	
Traffic Volume (veh/h)	154	0	1022	0	0	0	0	1247	628	43	792	0
Future Volume (veh/h)	154	0	1022	0	0	0	0	1247	628	43	792	0
Initial Q (Qb), veh	0	0	0				0	0	0	0	0	0
Lane Width Adj.	1.00	1.00	1.00				1.00	1.00	1.00	1.00	1.00	1.00
Ped-Bike Adj(A_pbT)	1.00		1.00				1.00		1.00	1.00		1.00
Parking Bus, Adj	1.00	1.00	1.00				1.00	1.00	1.00	1.00	1.00	1.00
Work Zone On Approach		No						No			No	
Adj Sat Flow, veh/h/ln	1885	1885	1885				0	1885	1885	1870	1870	0
Adj Flow Rate, veh/h	169	0	0				0	1370	0	47	870	0
Peak Hour Factor	0.91	0.91	0.91				0.91	0.91	0.91	0.91	0.91	0.91
Percent Heavy Veh, %	1	1	1				0	1	1	2	2	0
Cap, veh/h	241	0					0	3924		358	3004	0
Arrive On Green	0.07	0.00	0.00				0.00	0.51	0.00	0.07	1.00	0.00
Sat Flow, veh/h	3591	0	1598				0	5316	1598	1781	3647	0
Grp Volume(v), veh/h	169	0	0				0	1370	0	47	870	0
Grp Sat Flow(s),veh/h/ln	1795	0	1598				0	1716	1598	1781	1777	0
Q Serve(g_s), s	5.5	0.0	0.0				0.0	19.0	0.0	0.6	0.0	0.0
Cycle Q Clear(g_c), s	5.5	0.0	0.0				0.0	19.0	0.0	0.6	0.0	0.0
Prop In Lane	1.00		1.00				0.00		1.00	1.00		0.00
Lane Grp Cap(c), veh/h	241	0					0	3924		358	3004	0
V/C Ratio(X)	0.70	0.00					0.00	0.35		0.13	0.29	0.00
Avail Cap(c_a), veh/h	1197	0					0	3924		678	3004	0
HCM Platoon Ratio	1.00	1.00	1.00				1.00	0.67	0.67	2.00	2.00	1.00
Upstream Filter(I)	1.00	0.00	0.00				0.00	0.56	0.00	0.86	0.86	0.00
Uniform Delay (d), s/veh	54.8	0.0	0.0				0.0	11.6	0.0	4.1	0.0	0.0
Incr Delay (d2), s/veh	3.7	0.0	0.0				0.0	0.1	0.0	0.1	0.2	0.0
Initial Q Delay(d3), s/veh	0.0	0.0	0.0				0.0	0.0	0.0	0.0	0.0	0.0
%ile BackOfQ(95%),veh/ln	4.7	0.0	0.0				0.0	11.3	0.0	0.3	0.2	0.0
Unsig. Movement Delay, s/veh												
LnGrp Delay(d), s/veh	58.5	0.0	0.0				0.0	11.8	0.0	4.3	0.2	0.0
LnGrp LOS	E							B		A	A	
Approach Vol, veh/h		169						1370			917	
Approach Delay, s/veh		58.5						11.8			0.4	
Approach LOS		E						B			A	
Timer - Assigned Phs	1	2		4				6				
Phs Duration (G+Y+Rc), s	10.0	97.5		12.6				107.4				
Change Period (Y+Rc), s	6.0	6.0		4.5				6.0				
Max Green Setting (Gmax), s	25.5	38.0		40.0				69.5				
Max Q Clear Time (g_c+I1), s	2.6	21.0		7.5				2.0				
Green Ext Time (p_c), s	0.1	8.7		0.6				7.0				

Intersection Summary												
HCM 7th Control Delay, s/veh			10.7									
HCM 7th LOS			B									

Notes  
 User approved volume balancing among the lanes for turning movement.  
 Unsignalized Delay for [NBR, EBR] is excluded from calculations of the approach delay and intersection delay.

Timings  
 6: Kendrick Castillo Way & C-470 EB Off-Ramp/C-470 EB On-Ramp

2028 Total PM  
 02/05/2026

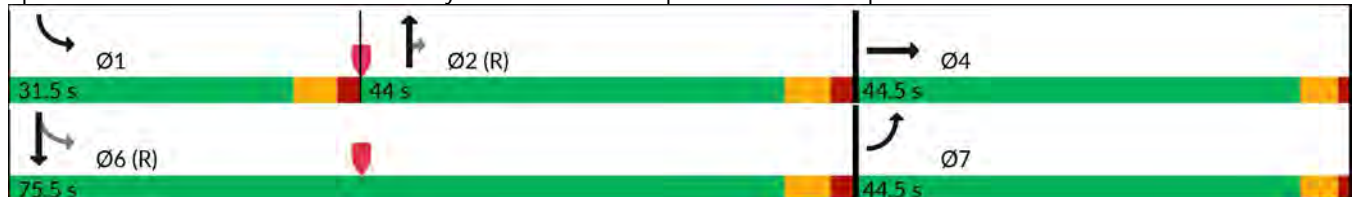


Lane Group	EBL	EBT	EBR	NBT	NBR	SBL	SBT
Lane Configurations	↶	↷	↶	↑↑↑	↶	↶	↑↑
Traffic Volume (vph)	75	0	928	1225	717	113	966
Future Volume (vph)	75	0	928	1225	717	113	966
Turn Type	Prot	NA	Free	NA	Perm	pm+pt	NA
Protected Phases	7	4		2		1	6
Permitted Phases			Free		2	6	
Detector Phase	7	4		2	2	1	6
Switch Phase							
Minimum Initial (s)	5.0	5.0		5.0	5.0	5.0	5.0
Minimum Split (s)	9.5	22.5		24.0	24.0	11.0	24.0
Total Split (s)	44.5	44.5		44.0	44.0	31.5	75.5
Total Split (%)	37.1%	37.1%		36.7%	36.7%	26.3%	62.9%
Yellow Time (s)	3.5	3.5		4.0	4.0	4.0	4.0
All-Red Time (s)	1.0	1.0		2.0	2.0	2.0	2.0
Lost Time Adjust (s)	0.0	0.0		0.0	0.0	0.0	0.0
Total Lost Time (s)	4.5	4.5		6.0	6.0	6.0	6.0
Lead/Lag				Lag	Lag	Lead	
Lead-Lag Optimize?				Yes	Yes	Yes	
Recall Mode	None	None		C-Max	C-Max	None	C-Max

Intersection Summary

Cycle Length: 120  
 Actuated Cycle Length: 120  
 Offset: 0 (0%), Referenced to phase 2:NBT and 6:SBTL, Start of Green  
 Natural Cycle: 60  
 Control Type: Actuated-Coordinated

Splits and Phases: 6: Kendrick Castillo Way & C-470 EB Off-Ramp/C-470 EB On-Ramp



HCM 7th Signalized Intersection Summary  
 6: Kendrick Castillo Way & C-470 EB Off-Ramp/C-470 EB On-Ramp

2028 Total PM  
 02/05/2026



Movement	EBL	EBT	EBR	WBL	WBT	WBR	NBL	NBT	NBR	SBL	SBT	SBR
Lane Configurations	↗	↘	↖					↑↑↑	↗	↘	↑↑	
Traffic Volume (veh/h)	75	0	928	0	0	0	0	1225	717	113	966	0
Future Volume (veh/h)	75	0	928	0	0	0	0	1225	717	113	966	0
Initial Q (Qb), veh	0	0	0				0	0	0	0	0	0
Lane Width Adj.	1.00	1.00	1.00				1.00	1.00	1.00	1.00	1.00	1.00
Ped-Bike Adj(A_pbT)	1.00		1.00				1.00		1.00	1.00		1.00
Parking Bus, Adj	1.00	1.00	1.00				1.00	1.00	1.00	1.00	1.00	1.00
Work Zone On Approach		No						No			No	
Adj Sat Flow, veh/h/ln	1900	1900	1900				0	1900	1900	1900	1900	0
Adj Flow Rate, veh/h	82	0	0				0	1332	0	123	1050	0
Peak Hour Factor	0.92	0.92	0.92				0.92	0.92	0.92	0.92	0.92	0.92
Percent Heavy Veh, %	0	0	0				0	0	0	0	0	0
Cap, veh/h	141	0					0	4059		430	3153	0
Arrive On Green	0.04	0.00	0.00				0.00	0.78	0.00	0.08	1.00	0.00
Sat Flow, veh/h	3619	0	1610				0	5358	1610	1810	3705	0
Grp Volume(v), veh/h	82	0	0				0	1332	0	123	1050	0
Grp Sat Flow(s),veh/h/ln	1810	0	1610				0	1729	1610	1810	1805	0
Q Serve(g_s), s	2.7	0.0	0.0				0.0	9.0	0.0	1.4	0.0	0.0
Cycle Q Clear(g_c), s	2.7	0.0	0.0				0.0	9.0	0.0	1.4	0.0	0.0
Prop In Lane	1.00		1.00				0.00		1.00	1.00		0.00
Lane Grp Cap(c), veh/h	141	0					0	4059		430	3153	0
V/C Ratio(X)	0.58	0.00					0.00	0.33		0.29	0.33	0.00
Avail Cap(c_a), veh/h	1206	0					0	4059		740	3153	0
HCM Platoon Ratio	1.00	1.00	1.00				1.00	1.00	1.00	2.00	2.00	1.00
Upstream Filter(I)	1.00	0.00	0.00				0.00	0.67	0.00	0.77	0.77	0.00
Uniform Delay (d), s/veh	56.7	0.0	0.0				0.0	3.8	0.0	2.3	0.0	0.0
Incr Delay (d2), s/veh	3.8	0.0	0.0				0.0	0.1	0.0	0.3	0.2	0.0
Initial Q Delay(d3), s/veh	0.0	0.0	0.0				0.0	0.0	0.0	0.0	0.0	0.0
%ile BackOfQ(95%),veh/ln	2.3	0.0	0.0				0.0	4.3	0.0	0.5	0.2	0.0
Unsig. Movement Delay, s/veh												
LnGrp Delay(d), s/veh	60.5	0.0	0.0				0.0	4.0	0.0	2.5	0.2	0.0
LnGrp LOS	E							A		A	A	
Approach Vol, veh/h		82						1332			1173	
Approach Delay, s/veh		60.5						4.0			0.5	
Approach LOS		E						A			A	
Timer - Assigned Phs	1	2		4				6				
Phs Duration (G+Y+Rc), s	10.9	99.9		9.2				110.8				
Change Period (Y+Rc), s	6.0	6.0		4.5				6.0				
Max Green Setting (Gmax), s	25.5	38.0		40.0				69.5				
Max Q Clear Time (g_c+I1), s	3.4	11.0		4.7				2.0				
Green Ext Time (p_c), s	0.3	10.6		0.2				9.2				

Intersection Summary												
HCM 7th Control Delay, s/veh			4.2									
HCM 7th LOS			A									

Notes  
 User approved volume balancing among the lanes for turning movement.  
 Unsignalized Delay for [NBR, EBR] is excluded from calculations of the approach delay and intersection delay.

Timings  
 6: Kendrick Castillo Way & C-470 EB Off-Ramp/C-470 EB On-Ramp

2045 Background AM  
 02/05/2026

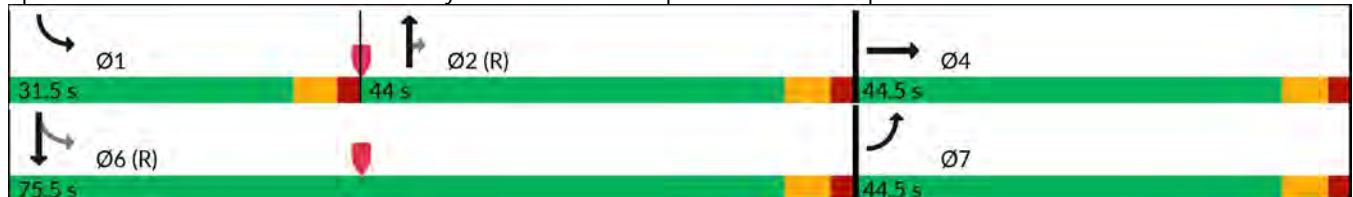


Lane Group	EBL	EBT	EBR	NBT	NBR	SBL	SBT
Lane Configurations	↶	↷	↶	↑↑↑	↶	↶	↑↑
Traffic Volume (vph)	182	0	1204	1452	725	51	929
Future Volume (vph)	182	0	1204	1452	725	51	929
Turn Type	Prot	NA	Free	NA	Perm	pm+pt	NA
Protected Phases	7	4		2		1	6
Permitted Phases			Free		2	6	
Detector Phase	7	4		2	2	1	6
Switch Phase							
Minimum Initial (s)	5.0	5.0		5.0	5.0	5.0	5.0
Minimum Split (s)	11.0	24.0		24.0	24.0	11.0	24.0
Total Split (s)	44.5	44.5		44.0	44.0	31.5	75.5
Total Split (%)	37.1%	37.1%		36.7%	36.7%	26.3%	62.9%
Yellow Time (s)	4.0	4.0		4.0	4.0	4.0	4.0
All-Red Time (s)	2.0	2.0		2.0	2.0	2.0	2.0
Lost Time Adjust (s)	0.0	0.0		0.0	0.0	0.0	0.0
Total Lost Time (s)	6.0	6.0		6.0	6.0	6.0	6.0
Lead/Lag				Lag	Lag	Lead	
Lead-Lag Optimize?				Yes	Yes	Yes	
Recall Mode	None	None		C-Max	C-Max	None	C-Max

Intersection Summary

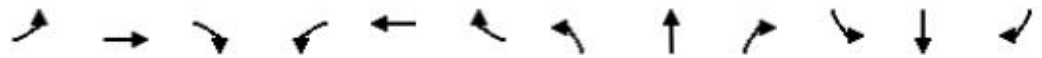
Cycle Length: 120  
 Actuated Cycle Length: 120  
 Offset: 0 (0%), Referenced to phase 2:NBT and 6:SBTL, Start of Green  
 Natural Cycle: 60  
 Control Type: Actuated-Coordinated

Splits and Phases: 6: Kendrick Castillo Way & C-470 EB Off-Ramp/C-470 EB On-Ramp



HCM 7th Signalized Intersection Summary  
 6: Kendrick Castillo Way & C-470 EB Off-Ramp/C-470 EB On-Ramp

2045 Background AM  
 02/05/2026



Movement	EBL	EBT	EBR	WBL	WBT	WBR	NBL	NBT	NBR	SBL	SBT	SBR
Lane Configurations	↘	↙	↗					↑↑↑	↗	↘	↑↑	
Traffic Volume (veh/h)	182	0	1204	0	0	0	0	1452	725	51	929	0
Future Volume (veh/h)	182	0	1204	0	0	0	0	1452	725	51	929	0
Initial Q (Qb), veh	0	0	0				0	0	0	0	0	0
Lane Width Adj.	1.00	1.00	1.00				1.00	1.00	1.00	1.00	1.00	1.00
Ped-Bike Adj(A_pbT)	1.00		1.00				1.00		1.00	1.00		1.00
Parking Bus, Adj	1.00	1.00	1.00				1.00	1.00	1.00	1.00	1.00	1.00
Work Zone On Approach		No						No			No	
Adj Sat Flow, veh/h/ln	1885	1885	1885				0	1885	1885	1870	1870	0
Adj Flow Rate, veh/h	200	0	0				0	1596	0	56	1021	0
Peak Hour Factor	0.91	0.91	0.91				0.91	0.91	0.91	0.91	0.91	0.91
Percent Heavy Veh, %	1	1	1				0	1	1	2	2	0
Cap, veh/h	275	0					0	3799		321	2926	0
Arrive On Green	0.08	0.00	0.00				0.00	0.74	0.00	0.07	1.00	0.00
Sat Flow, veh/h	3591	0	1598				0	5316	1598	1781	3647	0
Grp Volume(v), veh/h	200	0	0				0	1596	0	56	1021	0
Grp Sat Flow(s),veh/h/ln	1795	0	1598				0	1716	1598	1781	1777	0
Q Serve(g_s), s	6.5	0.0	0.0				0.0	14.1	0.0	0.8	0.0	0.0
Cycle Q Clear(g_c), s	6.5	0.0	0.0				0.0	14.1	0.0	0.8	0.0	0.0
Prop In Lane	1.00		1.00				0.00		1.00	1.00		0.00
Lane Grp Cap(c), veh/h	275	0					0	3799		321	2926	0
V/C Ratio(X)	0.73	0.00					0.00	0.42		0.17	0.35	0.00
Avail Cap(c_a), veh/h	1152	0					0	3799		636	2926	0
HCM Platoon Ratio	1.00	1.00	1.00				1.00	1.00	1.00	2.00	2.00	1.00
Upstream Filter(I)	1.00	0.00	0.00				0.00	0.41	0.00	0.77	0.77	0.00
Uniform Delay (d), s/veh	54.2	0.0	0.0				0.0	6.0	0.0	3.9	0.0	0.0
Incr Delay (d2), s/veh	3.7	0.0	0.0				0.0	0.1	0.0	0.2	0.3	0.0
Initial Q Delay(d3), s/veh	0.0	0.0	0.0				0.0	0.0	0.0	0.0	0.0	0.0
%ile BackOfQ(95%),veh/ln	5.5	0.0	0.0				0.0	6.4	0.0	0.4	0.2	0.0
Unsig. Movement Delay, s/veh												
LnGrp Delay(d), s/veh	57.8	0.0	0.0				0.0	6.1	0.0	4.1	0.3	0.0
LnGrp LOS	E							A		A	A	
Approach Vol, veh/h		200						1596			1077	
Approach Delay, s/veh		57.8						6.1			0.5	
Approach LOS		E						A			A	
Timer - Assigned Phs	1	2		4				6				
Phs Duration (G+Y+Rc), s	10.2	94.6		15.2				104.8				
Change Period (Y+Rc), s	6.0	6.0		6.0				6.0				
Max Green Setting (Gmax), s	25.5	38.0		38.5				69.5				
Max Q Clear Time (g_c+I1), s	2.8	16.1		8.5				2.0				
Green Ext Time (p_c), s	0.1	11.8		0.7				8.9				

Intersection Summary												
HCM 7th Control Delay, s/veh											7.6	
HCM 7th LOS											A	

Notes  
 User approved volume balancing among the lanes for turning movement.  
 Unsignalized Delay for [NBR, EBR] is excluded from calculations of the approach delay and intersection delay.

Timings  
 6: Kendrick Castillo Way & C-470 EB Off-Ramp/C-470 EB On-Ramp

2045 Background PM  
 02/05/2026

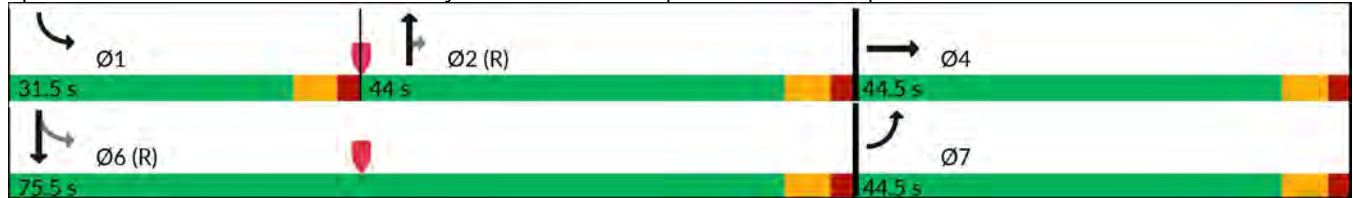


Lane Group	EBL	EBT	EBR	NBT	NBR	SBL	SBT
Lane Configurations	↶	↷	↶	↑↑↑	↶	↶	↑↑
Traffic Volume (vph)	89	0	1078	1434	837	134	1117
Future Volume (vph)	89	0	1078	1434	837	134	1117
Turn Type	Prot	NA	Free	NA	Perm	pm+pt	NA
Protected Phases	7	4		2		1	6
Permitted Phases			Free		2	6	
Detector Phase	7	4		2	2	1	6
Switch Phase							
Minimum Initial (s)	5.0	5.0		5.0	5.0	5.0	5.0
Minimum Split (s)	11.0	24.0		24.0	24.0	11.0	24.0
Total Split (s)	44.5	44.5		44.0	44.0	31.5	75.5
Total Split (%)	37.1%	37.1%		36.7%	36.7%	26.3%	62.9%
Yellow Time (s)	4.0	4.0		4.0	4.0	4.0	4.0
All-Red Time (s)	2.0	2.0		2.0	2.0	2.0	2.0
Lost Time Adjust (s)	0.0	0.0		0.0	0.0	0.0	0.0
Total Lost Time (s)	6.0	6.0		6.0	6.0	6.0	6.0
Lead/Lag				Lag	Lag	Lead	
Lead-Lag Optimize?				Yes	Yes	Yes	
Recall Mode	None	None		C-Max	C-Max	None	C-Max

Intersection Summary

Cycle Length: 120  
 Actuated Cycle Length: 120  
 Offset: 0 (0%), Referenced to phase 2:NBT and 6:SBTL, Start of Green  
 Natural Cycle: 60  
 Control Type: Actuated-Coordinated

Splits and Phases: 6: Kendrick Castillo Way & C-470 EB Off-Ramp/C-470 EB On-Ramp



HCM 7th Signalized Intersection Summary  
 6: Kendrick Castillo Way & C-470 EB Off-Ramp/C-470 EB On-Ramp

2045 Background PM  
 02/05/2026



Movement	EBL	EBT	EBR	WBL	WBT	WBR	NBL	NBT	NBR	SBL	SBT	SBR
Lane Configurations	↗	↘	↖					↑↑↑	↗	↘	↑↑	
Traffic Volume (veh/h)	89	0	1078	0	0	0	0	1434	837	134	1117	0
Future Volume (veh/h)	89	0	1078	0	0	0	0	1434	837	134	1117	0
Initial Q (Qb), veh	0	0	0				0	0	0	0	0	0
Lane Width Adj.	1.00	1.00	1.00				1.00	1.00	1.00	1.00	1.00	1.00
Ped-Bike Adj(A_pbT)	1.00		1.00				1.00		1.00	1.00		1.00
Parking Bus, Adj	1.00	1.00	1.00				1.00	1.00	1.00	1.00	1.00	1.00
Work Zone On Approach		No						No			No	
Adj Sat Flow, veh/h/ln	1900	1900	1900				0	1900	1900	1900	1900	0
Adj Flow Rate, veh/h	97	0	0				0	1559	0	146	1214	0
Peak Hour Factor	0.92	0.92	0.92				0.92	0.92	0.92	0.92	0.92	0.92
Percent Heavy Veh, %	0	0	0				0	0	0	0	0	0
Cap, veh/h	158	0					0	3968		358	3091	0
Arrive On Green	0.04	0.00	0.00				0.00	0.76	0.00	0.08	1.00	0.00
Sat Flow, veh/h	3619	0	1610				0	5358	1610	1810	3705	0
Grp Volume(v), veh/h	97	0	0				0	1559	0	146	1214	0
Grp Sat Flow(s),veh/h/ln	1810	0	1610				0	1729	1610	1810	1805	0
Q Serve(g_s), s	3.2	0.0	0.0				0.0	12.1	0.0	2.0	0.0	0.0
Cycle Q Clear(g_c), s	3.2	0.0	0.0				0.0	12.1	0.0	2.0	0.0	0.0
Prop In Lane	1.00		1.00				0.00		1.00	1.00		0.00
Lane Grp Cap(c), veh/h	158	0					0	3968		358	3091	0
V/C Ratio(X)	0.61	0.00					0.00	0.39		0.41	0.39	0.00
Avail Cap(c_a), veh/h	1161	0					0	3968		668	3091	0
HCM Platoon Ratio	1.00	1.00	1.00				1.00	1.00	1.00	2.00	2.00	1.00
Upstream Filter(I)	1.00	0.00	0.00				0.00	0.45	0.00	0.59	0.59	0.00
Uniform Delay (d), s/veh	56.4	0.0	0.0				0.0	4.7	0.0	3.3	0.0	0.0
Incr Delay (d2), s/veh	3.8	0.0	0.0				0.0	0.1	0.0	0.4	0.2	0.0
Initial Q Delay(d3), s/veh	0.0	0.0	0.0				0.0	0.0	0.0	0.0	0.0	0.0
%ile BackOfQ(95%),veh/ln	2.7	0.0	0.0				0.0	5.4	0.0	0.8	0.2	0.0
Unsig. Movement Delay, s/veh												
LnGrp Delay(d), s/veh	60.2	0.0	0.0				0.0	4.9	0.0	3.8	0.2	0.0
LnGrp LOS	E							A		A	A	
Approach Vol, veh/h		97						1559			1360	
Approach Delay, s/veh		60.2						4.9			0.6	
Approach LOS		E						A			A	
Timer - Assigned Phs	1	2		4				6				
Phs Duration (G+Y+Rc), s	11.0	97.8		11.2				108.8				
Change Period (Y+Rc), s	6.0	6.0		6.0				6.0				
Max Green Setting (Gmax), s	25.5	38.0		38.5				69.5				
Max Q Clear Time (g_c+I1), s	4.0	14.1		5.2				2.0				
Green Ext Time (p_c), s	0.3	12.1		0.3				11.7				

Intersection Summary

HCM 7th Control Delay, s/veh	4.7
HCM 7th LOS	A

Notes

User approved volume balancing among the lanes for turning movement.  
 Unsignalized Delay for [NBR, EBR] is excluded from calculations of the approach delay and intersection delay.

Timings  
 6: Kendrick Castillo Way & C-470 EB Off-Ramp/C-470 EB On-Ramp

2045 Total AM  
 02/05/2026

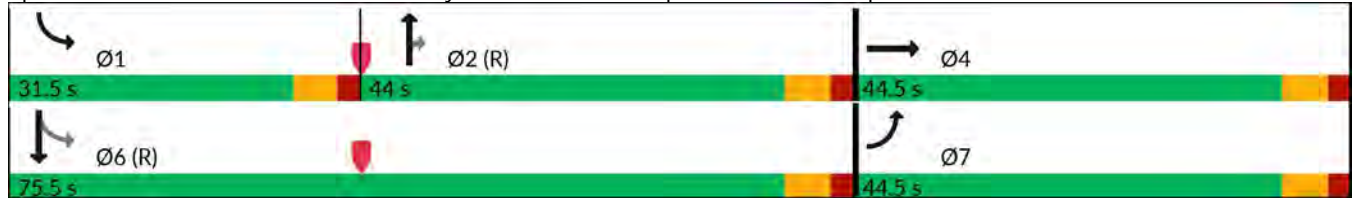


Lane Group	EBL	EBT	EBR	NBT	NBR	SBL	SBT
Lane Configurations	↶	↷	↶	↑↑↑	↶	↶	↑↑
Traffic Volume (vph)	182	0	1209	1473	741	51	936
Future Volume (vph)	182	0	1209	1473	741	51	936
Turn Type	Prot	NA	Free	NA	Perm	pm+pt	NA
Protected Phases	7	4		2		1	6
Permitted Phases			Free		2	6	
Detector Phase	7	4		2	2	1	6
Switch Phase							
Minimum Initial (s)	5.0	5.0		5.0	5.0	5.0	5.0
Minimum Split (s)	11.0	24.0		24.0	24.0	11.0	24.0
Total Split (s)	44.5	44.5		44.0	44.0	31.5	75.5
Total Split (%)	37.1%	37.1%		36.7%	36.7%	26.3%	62.9%
Yellow Time (s)	4.0	4.0		4.0	4.0	4.0	4.0
All-Red Time (s)	2.0	2.0		2.0	2.0	2.0	2.0
Lost Time Adjust (s)	0.0	0.0		0.0	0.0	0.0	0.0
Total Lost Time (s)	6.0	6.0		6.0	6.0	6.0	6.0
Lead/Lag				Lag	Lag	Lead	
Lead-Lag Optimize?				Yes	Yes	Yes	
Recall Mode	None	None		C-Max	C-Max	None	C-Max

Intersection Summary

Cycle Length: 120  
 Actuated Cycle Length: 120  
 Offset: 0 (0%), Referenced to phase 2:NBT and 6:SBTL, Start of Green  
 Natural Cycle: 60  
 Control Type: Actuated-Coordinated

Splits and Phases: 6: Kendrick Castillo Way & C-470 EB Off-Ramp/C-470 EB On-Ramp



HCM 7th Signalized Intersection Summary  
 6: Kendrick Castillo Way & C-470 EB Off-Ramp/C-470 EB On-Ramp

2045 Total AM  
 02/05/2026



Movement	EBL	EBT	EBR	WBL	WBT	WBR	NBL	NBT	NBR	SBL	SBT	SBR
Lane Configurations	↗	↘	↖					↑↑↑	↗	↘	↑↑	
Traffic Volume (veh/h)	182	0	1209	0	0	0	0	1473	741	51	936	0
Future Volume (veh/h)	182	0	1209	0	0	0	0	1473	741	51	936	0
Initial Q (Qb), veh	0	0	0				0	0	0	0	0	0
Lane Width Adj.	1.00	1.00	1.00				1.00	1.00	1.00	1.00	1.00	1.00
Ped-Bike Adj(A_pbT)	1.00		1.00				1.00		1.00	1.00		1.00
Parking Bus, Adj	1.00	1.00	1.00				1.00	1.00	1.00	1.00	1.00	1.00
Work Zone On Approach		No						No			No	
Adj Sat Flow, veh/h/ln	1885	1885	1885				0	1885	1885	1870	1870	0
Adj Flow Rate, veh/h	200	0	0				0	1619	0	56	1029	0
Peak Hour Factor	0.91	0.91	0.91				0.91	0.91	0.91	0.91	0.91	0.91
Percent Heavy Veh, %	1	1	1				0	1	1	2	2	0
Cap, veh/h	275	0					0	3799		316	2926	0
Arrive On Green	0.08	0.00	0.00				0.00	0.74	0.00	0.07	1.00	0.00
Sat Flow, veh/h	3591	0	1598				0	5316	1598	1781	3647	0
Grp Volume(v), veh/h	200	0	0				0	1619	0	56	1029	0
Grp Sat Flow(s),veh/h/ln	1795	0	1598				0	1716	1598	1781	1777	0
Q Serve(g_s), s	6.5	0.0	0.0				0.0	14.4	0.0	0.8	0.0	0.0
Cycle Q Clear(g_c), s	6.5	0.0	0.0				0.0	14.4	0.0	0.8	0.0	0.0
Prop In Lane	1.00		1.00				0.00		1.00	1.00		0.00
Lane Grp Cap(c), veh/h	275	0					0	3799		316	2926	0
V/C Ratio(X)	0.73	0.00					0.00	0.43		0.18	0.35	0.00
Avail Cap(c_a), veh/h	1152	0					0	3799		631	2926	0
HCM Platoon Ratio	1.00	1.00	1.00				1.00	1.00	1.00	2.00	2.00	1.00
Upstream Filter(I)	1.00	0.00	0.00				0.00	0.33	0.00	0.76	0.76	0.00
Uniform Delay (d), s/veh	54.2	0.0	0.0				0.0	6.0	0.0	3.9	0.0	0.0
Incr Delay (d2), s/veh	3.7	0.0	0.0				0.0	0.1	0.0	0.2	0.3	0.0
Initial Q Delay(d3), s/veh	0.0	0.0	0.0				0.0	0.0	0.0	0.0	0.0	0.0
%ile BackOfQ(95%),veh/ln	5.5	0.0	0.0				0.0	6.2	0.0	0.4	0.2	0.0
Unsig. Movement Delay, s/veh												
LnGrp Delay(d), s/veh	57.8	0.0	0.0				0.0	6.1	0.0	4.1	0.3	0.0
LnGrp LOS	E							A		A	A	
Approach Vol, veh/h		200						1619			1085	
Approach Delay, s/veh		57.8						6.1			0.5	
Approach LOS		E						A			A	
Timer - Assigned Phs	1	2		4				6				
Phs Duration (G+Y+Rc), s	10.2	94.6		15.2				104.8				
Change Period (Y+Rc), s	6.0	6.0		6.0				6.0				
Max Green Setting (Gmax), s	25.5	38.0		38.5				69.5				
Max Q Clear Time (g_c+I1), s	2.8	16.4		8.5				2.0				
Green Ext Time (p_c), s	0.1	11.9		0.7				9.0				

Intersection Summary

HCM 7th Control Delay, s/veh	7.6
HCM 7th LOS	A

Notes

User approved volume balancing among the lanes for turning movement.  
 Unsignalized Delay for [NBR, EBR] is excluded from calculations of the approach delay and intersection delay.

Timings  
 6: Kendrick Castillo Way & C-470 EB Off-Ramp/C-470 EB On-Ramp

2045 Total PM  
 02/05/2026

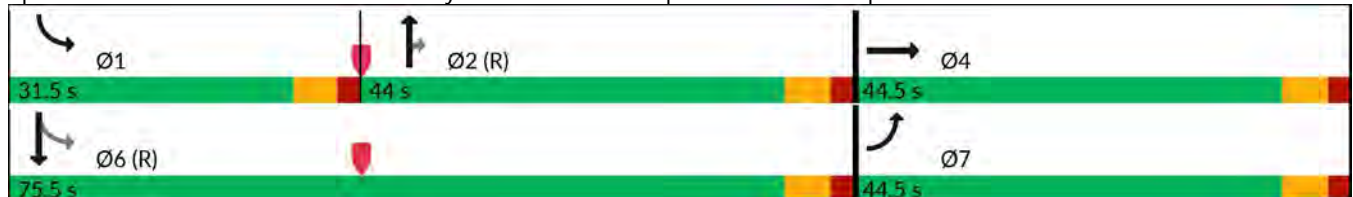


Lane Group	EBL	EBT	EBR	NBT	NBR	SBL	SBT
Lane Configurations	↶	↷	↶	↑↑↑	↶	↶	↑↑
Traffic Volume (vph)	89	0	1094	1448	847	134	1138
Future Volume (vph)	89	0	1094	1448	847	134	1138
Turn Type	Prot	NA	Free	NA	Perm	pm+pt	NA
Protected Phases	7	4		2		1	6
Permitted Phases			Free		2	6	
Detector Phase	7	4		2	2	1	6
Switch Phase							
Minimum Initial (s)	5.0	5.0		5.0	5.0	5.0	5.0
Minimum Split (s)	11.0	24.0		24.0	24.0	11.0	24.0
Total Split (s)	44.5	44.5		44.0	44.0	31.5	75.5
Total Split (%)	37.1%	37.1%		36.7%	36.7%	26.3%	62.9%
Yellow Time (s)	4.0	4.0		4.0	4.0	4.0	4.0
All-Red Time (s)	2.0	2.0		2.0	2.0	2.0	2.0
Lost Time Adjust (s)	0.0	0.0		0.0	0.0	0.0	0.0
Total Lost Time (s)	6.0	6.0		6.0	6.0	6.0	6.0
Lead/Lag				Lag	Lag	Lead	
Lead-Lag Optimize?				Yes	Yes	Yes	
Recall Mode	None	None		C-Max	C-Max	None	C-Max

Intersection Summary

Cycle Length: 120  
 Actuated Cycle Length: 120  
 Offset: 0 (0%), Referenced to phase 2:NBT and 6:SBTL, Start of Green  
 Natural Cycle: 60  
 Control Type: Actuated-Coordinated

Splits and Phases: 6: Kendrick Castillo Way & C-470 EB Off-Ramp/C-470 EB On-Ramp



HCM 7th Signalized Intersection Summary  
 6: Kendrick Castillo Way & C-470 EB Off-Ramp/C-470 EB On-Ramp

2045 Total PM  
 02/05/2026



Movement	EBL	EBT	EBR	WBL	WBT	WBR	NBL	NBT	NBR	SBL	SBT	SBR
Lane Configurations	↗	↘	↖					↑↑↑	↗	↘	↑↑	
Traffic Volume (veh/h)	89	0	1094	0	0	0	0	1448	847	134	1138	0
Future Volume (veh/h)	89	0	1094	0	0	0	0	1448	847	134	1138	0
Initial Q (Qb), veh	0	0	0				0	0	0	0	0	0
Lane Width Adj.	1.00	1.00	1.00				1.00	1.00	1.00	1.00	1.00	1.00
Ped-Bike Adj(A_pbT)	1.00		1.00				1.00		1.00	1.00		1.00
Parking Bus, Adj	1.00	1.00	1.00				1.00	1.00	1.00	1.00	1.00	1.00
Work Zone On Approach		No						No			No	
Adj Sat Flow, veh/h/ln	1900	1900	1900				0	1900	1900	1900	1900	0
Adj Flow Rate, veh/h	97	0	0				0	1574	0	146	1237	0
Peak Hour Factor	0.92	0.92	0.92				0.92	0.92	0.92	0.92	0.92	0.92
Percent Heavy Veh, %	0	0	0				0	0	0	0	0	0
Cap, veh/h	158	0					0	3968		354	3091	0
Arrive On Green	0.04	0.00	0.00				0.00	0.76	0.00	0.08	1.00	0.00
Sat Flow, veh/h	3619	0	1610				0	5358	1610	1810	3705	0
Grp Volume(v), veh/h	97	0	0				0	1574	0	146	1237	0
Grp Sat Flow(s),veh/h/ln	1810	0	1610				0	1729	1610	1810	1805	0
Q Serve(g_s), s	3.2	0.0	0.0				0.0	12.3	0.0	2.0	0.0	0.0
Cycle Q Clear(g_c), s	3.2	0.0	0.0				0.0	12.3	0.0	2.0	0.0	0.0
Prop In Lane	1.00		1.00				0.00		1.00	1.00		0.00
Lane Grp Cap(c), veh/h	158	0					0	3968		354	3091	0
V/C Ratio(X)	0.61	0.00					0.00	0.40		0.41	0.40	0.00
Avail Cap(c_a), veh/h	1161	0					0	3968		664	3091	0
HCM Platoon Ratio	1.00	1.00	1.00				1.00	1.00	1.00	2.00	2.00	1.00
Upstream Filter(I)	1.00	0.00	0.00				0.00	0.43	0.00	0.57	0.57	0.00
Uniform Delay (d), s/veh	56.4	0.0	0.0				0.0	4.8	0.0	3.4	0.0	0.0
Incr Delay (d2), s/veh	3.8	0.0	0.0				0.0	0.1	0.0	0.4	0.2	0.0
Initial Q Delay(d3), s/veh	0.0	0.0	0.0				0.0	0.0	0.0	0.0	0.0	0.0
%ile BackOfQ(95%),veh/ln	2.7	0.0	0.0				0.0	5.4	0.0	0.8	0.2	0.0
Unsig. Movement Delay, s/veh												
LnGrp Delay(d), s/veh	60.2	0.0	0.0				0.0	4.9	0.0	3.8	0.2	0.0
LnGrp LOS	E							A		A	A	
Approach Vol, veh/h		97						1574			1383	
Approach Delay, s/veh		60.2						4.9			0.6	
Approach LOS		E						A			A	
Timer - Assigned Phs	1	2		4			6					
Phs Duration (G+Y+Rc), s	11.0	97.8		11.2			108.8					
Change Period (Y+Rc), s	6.0	6.0		6.0			6.0					
Max Green Setting (Gmax), s	25.5	38.0		38.5			69.5					
Max Q Clear Time (g_c+I1), s	4.0	14.3		5.2			2.0					
Green Ext Time (p_c), s	0.3	12.2		0.3			12.0					

Intersection Summary		
HCM 7th Control Delay, s/veh		4.7
HCM 7th LOS		A

Notes  
 User approved volume balancing among the lanes for turning movement.  
 Unsignalized Delay for [NBR, EBR] is excluded from calculations of the approach delay and intersection delay.

Timings  
7: Kendrick Castillo Way & C-470 WB On-Ramp/C-470 WB Off-Ramp

2025 Existing AM  
06/09/2025

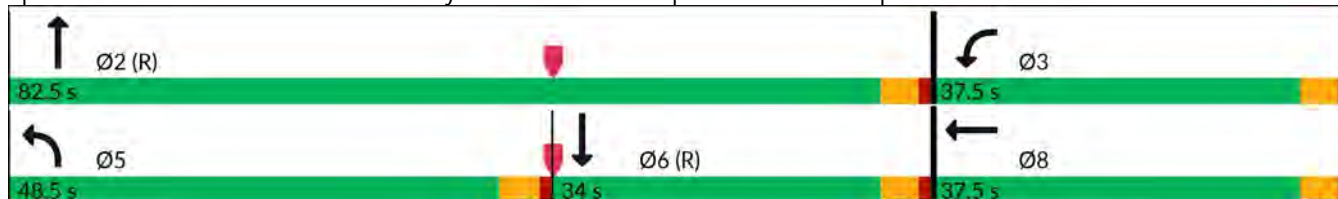


Lane Group	WBL	WBT	WBR	NBL	NBT	SBT	SBR
Lane Configurations	↶	↷	↷	↶↷	↶↷	↶↷	↷
Traffic Volume (vph)	599	2	150	733	635	215	33
Future Volume (vph)	599	2	150	733	635	215	33
Turn Type	Prot	NA	Free	Prot	NA	NA	Free
Protected Phases	3	8		5	2	6	
Permitted Phases			Free				Free
Detector Phase	3	8		5	2	6	
Switch Phase							
Minimum Initial (s)	5.0	5.0		5.0	5.0	5.0	
Minimum Split (s)	9.5	22.5		9.5	22.5	22.5	
Total Split (s)	37.5	37.5		48.5	82.5	34.0	
Total Split (%)	31.3%	31.3%		40.4%	68.8%	28.3%	
Yellow Time (s)	3.5	3.5		3.5	3.5	3.5	
All-Red Time (s)	1.0	1.0		1.0	1.0	1.0	
Lost Time Adjust (s)	0.0	0.0		0.0	0.0	0.0	
Total Lost Time (s)	4.5	4.5		4.5	4.5	4.5	
Lead/Lag				Lead		Lag	
Lead-Lag Optimize?				Yes		Yes	
Recall Mode	None	None		None	C-Max	C-Max	
Act Effct Green (s)	33.0	33.0	120.0	32.9	78.0	40.6	120.0
Actuated g/C Ratio	0.28	0.28	1.00	0.27	0.65	0.34	1.00
v/c Ratio	0.68	0.69	0.10	0.81	0.29	0.19	0.02
Control Delay (s/veh)	47.5	47.7	0.1	70.3	2.8	29.8	0.0
Queue Delay	0.0	0.0	0.0	0.0	0.0	0.0	0.0
Total Delay (s/veh)	47.5	47.7	0.1	70.3	2.8	29.8	0.0
LOS	D	D	A	E	A	C	A
Approach Delay (s/veh)		38.1			39.0	25.8	
Approach LOS		D			D	C	

Intersection Summary

Cycle Length: 120  
 Actuated Cycle Length: 120  
 Offset: 0 (0%), Referenced to phase 2:NBT and 6:SBT, Start of Green  
 Natural Cycle: 65  
 Control Type: Actuated-Coordinated  
 Maximum v/c Ratio: 0.81  
 Intersection Signal Delay (s/veh): 37.3  
 Intersection LOS: D  
 Intersection Capacity Utilization 58.9%  
 ICU Level of Service B  
 Analysis Period (min) 15

Splits and Phases: 7: Kendrick Castillo Way & C-470 WB On-Ramp/C-470 WB Off-Ramp



HCM 7th Signalized Intersection Summary  
 7: Kendrick Castillo Way & C-470 WB On-Ramp/C-470 WB Off-Ramp

2025 Existing AM  
 06/09/2025



Movement	EBL	EBT	EBR	WBL	WBT	WBR	NBL	NBT	NBR	SBL	SBT	SBR
Lane Configurations				↖	↖	↖	↖↖	↖↖			↖↖	↖
Traffic Volume (veh/h)	0	0	0	599	2	150	733	635	0	0	215	33
Future Volume (veh/h)	0	0	0	599	2	150	733	635	0	0	215	33
Initial Q (Qb), veh				0	0	0	0	0	0	0	0	0
Lane Width Adj.				1.00	1.00	1.00	1.00	1.00	1.00	1.00	1.00	1.00
Ped-Bike Adj(A_pbT)				1.00		1.00	1.00		1.00	1.00		1.00
Parking Bus, Adj				1.00	1.00	1.00	1.00	1.00	1.00	1.00	1.00	1.00
Work Zone On Approach				No			No				No	
Adj Sat Flow, veh/h/ln				1870	1870	1870	1885	1885	0	0	1870	1870
Adj Flow Rate, veh/h				632	0	0	772	668	0	0	226	0
Peak Hour Factor				0.95	0.95	0.95	0.95	0.95	0.95	0.95	0.95	0.95
Percent Heavy Veh, %				2	2	2	1	1	0	0	2	2
Cap, veh/h				725	0		858	2584	0	0	1554	
Arrive On Green				0.20	0.00	0.00	0.41	1.00	0.00	0.00	0.44	0.00
Sat Flow, veh/h				3563	0	1585	3483	3676	0	0	3647	1585
Grp Volume(v), veh/h				632	0	0	772	668	0	0	226	0
Grp Sat Flow(s),veh/h/ln				1781	0	1585	1742	1791	0	0	1777	1585
Q Serve(g_s), s				20.6	0.0	0.0	24.8	0.0	0.0	0.0	4.6	0.0
Cycle Q Clear(g_c), s				20.6	0.0	0.0	24.8	0.0	0.0	0.0	4.6	0.0
Prop In Lane				1.00		1.00	1.00		0.00	0.00		1.00
Lane Grp Cap(c), veh/h				725	0		858	2584	0	0	1554	
V/C Ratio(X)				0.87	0.00		0.90	0.26	0.00	0.00	0.15	
Avail Cap(c_a), veh/h				980	0		1277	2584	0	0	1554	
HCM Platoon Ratio				1.00	1.00	1.00	1.67	1.67	1.00	1.00	1.00	1.00
Upstream Filter(I)				1.00	0.00	0.00	0.91	0.91	0.00	0.00	1.00	0.00
Uniform Delay (d), s/veh				46.3	0.0	0.0	33.9	0.0	0.0	0.0	20.3	0.0
Incr Delay (d2), s/veh				6.7	0.0	0.0	5.7	0.2	0.0	0.0	0.2	0.0
Initial Q Delay(d3), s/veh				0.0	0.0	0.0	0.0	0.0	0.0	0.0	0.0	0.0
%ile BackOfQ(95%),veh/ln				14.8	0.0	0.0	14.1	0.1	0.0	0.0	3.4	0.0
Unsig. Movement Delay, s/veh												
LnGrp Delay(d), s/veh				52.9	0.0	0.0	39.7	0.2	0.0	0.0	20.5	0.0
LnGrp LOS				D			D	A			C	
Approach Vol, veh/h					632			1440			226	
Approach Delay, s/veh					52.9			21.4			20.5	
Approach LOS					D			C			C	
Timer - Assigned Phs		2			5	6		8				
Phs Duration (G+Y+Rc), s		91.1			34.1	57.0		28.9				
Change Period (Y+Rc), s		4.5			4.5	4.5		4.5				
Max Green Setting (Gmax), s		78.0			44.0	29.5		33.0				
Max Q Clear Time (g_c+I1), s		2.0			26.8	6.6		22.6				
Green Ext Time (p_c), s		4.9			2.7	1.3		1.8				

Intersection Summary		
HCM 7th Control Delay, s/veh		30.0
HCM 7th LOS		C

Notes  
 User approved volume balancing among the lanes for turning movement.  
 Unsignalized Delay for [WBR, SBR] is excluded from calculations of the approach delay and intersection delay.

Timings  
 7: Kendrick Castillo Way & C-470 WB On-Ramp/C-470 WB Off-Ramp

2025 Existing PM  
 06/09/2025

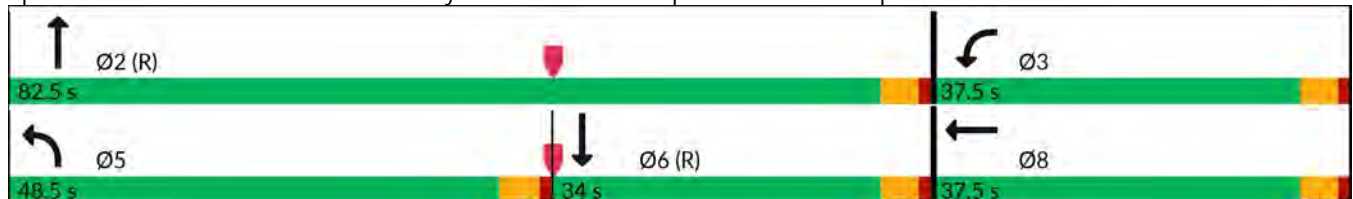


Lane Group	WBL	WBT	WBR	NBL	NBT	SBT	SBR
Lane Configurations	↶	↶	↶	↶↶	↶↶	↶↶	↶
Traffic Volume (vph)	565	1	82	798	432	519	120
Future Volume (vph)	565	1	82	798	432	519	120
Turn Type	Prot	NA	Free	Prot	NA	NA	Free
Protected Phases	3	8		5	2	6	
Permitted Phases			Free				Free
Detector Phase	3	8		5	2	6	
Switch Phase							
Minimum Initial (s)	5.0	5.0		5.0	5.0	5.0	
Minimum Split (s)	9.5	22.5		9.5	22.5	22.5	
Total Split (s)	37.5	37.5		48.5	82.5	34.0	
Total Split (%)	31.3%	31.3%		40.4%	68.8%	28.3%	
Yellow Time (s)	3.5	3.5		3.5	3.5	3.5	
All-Red Time (s)	1.0	1.0		1.0	1.0	1.0	
Lost Time Adjust (s)	0.0	0.0		0.0	0.0	0.0	
Total Lost Time (s)	4.5	4.5		4.5	4.5	4.5	
Lead/Lag				Lead		Lag	
Lead-Lag Optimize?				Yes		Yes	
Recall Mode	None	None		None	C-Max	C-Max	
Act Effct Green (s)	33.0	33.0	120.0	35.9	78.0	37.6	120.0
Actuated g/C Ratio	0.28	0.28	1.00	0.30	0.65	0.31	1.00
v/c Ratio	0.65	0.65	0.06	0.83	0.20	0.50	0.08
Control Delay (s/veh)	46.0	46.0	0.1	66.5	6.5	36.5	0.1
Queue Delay	0.0	0.0	0.0	0.0	0.0	0.0	0.0
Total Delay (s/veh)	46.0	46.0	0.1	66.5	6.5	36.5	0.1
LOS	D	D	A	E	A	D	A
Approach Delay (s/veh)		40.2			45.4	29.7	
Approach LOS		D			D	C	

Intersection Summary

Cycle Length: 120  
 Actuated Cycle Length: 120  
 Offset: 0 (0%), Referenced to phase 2:NBT and 6:SBT, Start of Green  
 Natural Cycle: 70  
 Control Type: Actuated-Coordinated  
 Maximum v/c Ratio: 0.83  
 Intersection Signal Delay (s/veh): 40.1  
 Intersection LOS: D  
 Intersection Capacity Utilization 66.5%  
 ICU Level of Service C  
 Analysis Period (min) 15

Splits and Phases: 7: Kendrick Castillo Way & C-470 WB On-Ramp/C-470 WB Off-Ramp



HCM 7th Signalized Intersection Summary  
 7: Kendrick Castillo Way & C-470 WB On-Ramp/C-470 WB Off-Ramp

2025 Existing PM  
 06/09/2025



Movement	EBL	EBT	EBR	WBL	WBT	WBR	NBL	NBT	NBR	SBL	SBT	SBR
Lane Configurations				↶	↷	↶	↶↷	↶↷			↶↷	↶
Traffic Volume (veh/h)	0	0	0	565	1	82	798	432	0	0	519	120
Future Volume (veh/h)	0	0	0	565	1	82	798	432	0	0	519	120
Initial Q (Qb), veh				0	0	0	0	0	0	0	0	0
Lane Width Adj.				1.00	1.00	1.00	1.00	1.00	1.00	1.00	1.00	1.00
Ped-Bike Adj(A_pbT)				1.00		1.00	1.00		1.00	1.00		1.00
Parking Bus, Adj				1.00	1.00	1.00	1.00	1.00	1.00	1.00	1.00	1.00
Work Zone On Approach				No			No				No	
Adj Sat Flow, veh/h/ln				1900	1900	1900	1900	1900	0	0	1900	1900
Adj Flow Rate, veh/h				615	0	0	867	470	0	0	564	0
Peak Hour Factor				0.92	0.92	0.92	0.92	0.92	0.92	0.92	0.92	0.92
Percent Heavy Veh, %				0	0	0	0	0	0	0	0	0
Cap, veh/h				711	0		952	2630	0	0	1516	
Arrive On Green				0.20	0.00	0.00	0.45	1.00	0.00	0.00	0.42	0.00
Sat Flow, veh/h				3619	0	1610	3510	3705	0	0	3705	1610
Grp Volume(v), veh/h				615	0	0	867	470	0	0	564	0
Grp Sat Flow(s),veh/h/ln				1810	0	1610	1755	1805	0	0	1805	1610
Q Serve(g_s), s				19.7	0.0	0.0	27.6	0.0	0.0	0.0	12.9	0.0
Cycle Q Clear(g_c), s				19.7	0.0	0.0	27.6	0.0	0.0	0.0	12.9	0.0
Prop In Lane				1.00		1.00	1.00		0.00	0.00		1.00
Lane Grp Cap(c), veh/h				711	0		952	2630	0	0	1516	
V/C Ratio(X)				0.87	0.00		0.91	0.18	0.00	0.00	0.37	
Avail Cap(c_a), veh/h				995	0		1287	2630	0	0	1516	
HCM Platoon Ratio				1.00	1.00	1.00	1.67	1.67	1.00	1.00	1.00	1.00
Upstream Filter(I)				1.00	0.00	0.00	0.92	0.92	0.00	0.00	1.00	0.00
Uniform Delay (d), s/veh				46.7	0.0	0.0	31.5	0.0	0.0	0.0	23.9	0.0
Incr Delay (d2), s/veh				5.9	0.0	0.0	7.3	0.1	0.0	0.0	0.7	0.0
Initial Q Delay(d3), s/veh				0.0	0.0	0.0	0.0	0.0	0.0	0.0	0.0	0.0
%ile BackOfQ(95%),veh/ln				14.4	0.0	0.0	15.3	0.1	0.0	0.0	9.3	0.0
Unsig. Movement Delay, s/veh												
LnGrp Delay(d), s/veh				52.6	0.0	0.0	38.8	0.1	0.0	0.0	24.6	0.0
LnGrp LOS				D			D	A			C	
Approach Vol, veh/h					615			1337			564	
Approach Delay, s/veh					52.6			25.2			24.6	
Approach LOS					D			C			C	
Timer - Assigned Phs		2			5	6		8				
Phs Duration (G+Y+Rc), s		91.9			37.1	54.9		28.1				
Change Period (Y+Rc), s		4.5			4.5	4.5		4.5				
Max Green Setting (Gmax), s		78.0			44.0	29.5		33.0				
Max Q Clear Time (g_c+I1), s		2.0			29.6	14.9		21.7				
Green Ext Time (p_c), s		3.2			3.0	3.0		1.8				

Intersection Summary		
HCM 7th Control Delay, s/veh		31.8
HCM 7th LOS		C

Notes  
 User approved volume balancing among the lanes for turning movement.  
 Unsignalized Delay for [WBR, SBR] is excluded from calculations of the approach delay and intersection delay.

Timings  
 7: Kendrick Castillo Way & C-470 WB On-Ramp/C-470 WB Off-Ramp

2028 Background AM  
 06/09/2025

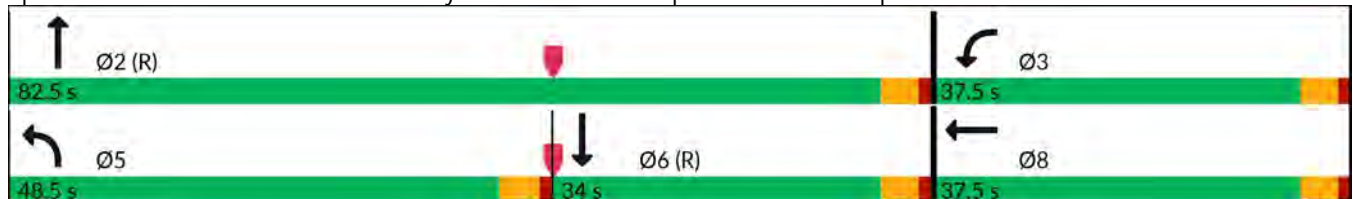


Lane Group	WBL	WBT	WBR	NBL	NBT	SBT	SBR
Lane Configurations	↶	↷	↶	↶↷	↶↷	↶↷	↶
Traffic Volume (vph)	620	2	155	755	654	224	34
Future Volume (vph)	620	2	155	755	654	224	34
Turn Type	Prot	NA	Free	Prot	NA	NA	Free
Protected Phases	3	8		5	2	6	
Permitted Phases			Free				Free
Detector Phase	3	8		5	2	6	
Switch Phase							
Minimum Initial (s)	5.0	5.0		5.0	5.0	5.0	
Minimum Split (s)	9.5	22.5		9.5	22.5	22.5	
Total Split (s)	37.5	37.5		48.5	82.5	34.0	
Total Split (%)	31.3%	31.3%		40.4%	68.8%	28.3%	
Yellow Time (s)	3.5	3.5		3.5	3.5	3.5	
All-Red Time (s)	1.0	1.0		1.0	1.0	1.0	
Lost Time Adjust (s)	0.0	0.0		0.0	0.0	0.0	
Total Lost Time (s)	4.5	4.5		4.5	4.5	4.5	
Lead/Lag				Lead		Lag	
Lead-Lag Optimize?				Yes		Yes	
Recall Mode	None	None		None	C-Max	C-Max	
Act Effect Green (s)	33.0	33.0	120.0	33.6	78.0	39.9	120.0
Actuated g/C Ratio	0.28	0.28	1.00	0.28	0.65	0.33	1.00
v/c Ratio	0.71	0.71	0.10	0.82	0.30	0.20	0.02
Control Delay (s/veh)	48.7	48.9	0.1	70.5	3.0	30.5	0.0
Queue Delay	0.0	0.0	0.0	0.0	0.0	0.0	0.0
Total Delay (s/veh)	48.7	48.9	0.1	70.5	3.0	30.5	0.0
LOS	D	D	A	E	A	C	A
Approach Delay (s/veh)		39.1			39.2	26.5	
Approach LOS		D			D	C	

Intersection Summary

Cycle Length: 120  
 Actuated Cycle Length: 120  
 Offset: 0 (0%), Referenced to phase 2:NBT and 6:SBT, Start of Green  
 Natural Cycle: 65  
 Control Type: Actuated-Coordinated  
 Maximum v/c Ratio: 0.82  
 Intersection Signal Delay (s/veh): 37.8  
 Intersection LOS: D  
 Intersection Capacity Utilization 60.1%  
 ICU Level of Service B  
 Analysis Period (min) 15

Splits and Phases: 7: Kendrick Castillo Way & C-470 WB On-Ramp/C-470 WB Off-Ramp



HCM 7th Signalized Intersection Summary  
 7: Kendrick Castillo Way & C-470 WB On-Ramp/C-470 WB Off-Ramp

2028 Background AM  
 06/09/2025



Movement	EBL	EBT	EBR	WBL	WBT	WBR	NBL	NBT	NBR	SBL	SBT	SBR
Lane Configurations				↶	↷	↶	↶↷	↶↷			↶↷	↶
Traffic Volume (veh/h)	0	0	0	620	2	155	755	654	0	0	224	34
Future Volume (veh/h)	0	0	0	620	2	155	755	654	0	0	224	34
Initial Q (Qb), veh				0	0	0	0	0	0	0	0	0
Lane Width Adj.				1.00	1.00	1.00	1.00	1.00	1.00	1.00	1.00	1.00
Ped-Bike Adj(A_pbT)				1.00		1.00	1.00		1.00	1.00		1.00
Parking Bus, Adj				1.00	1.00	1.00	1.00	1.00	1.00	1.00	1.00	1.00
Work Zone On Approach				No			No				No	
Adj Sat Flow, veh/h/ln				1870	1870	1870	1885	1885	0	0	1870	1870
Adj Flow Rate, veh/h				654	0	0	795	688	0	0	236	0
Peak Hour Factor				0.95	0.95	0.95	0.95	0.95	0.95	0.95	0.95	0.95
Percent Heavy Veh, %				2	2	2	1	1	0	0	2	2
Cap, veh/h				747	0		881	2562	0	0	1510	
Arrive On Green				0.21	0.00	0.00	0.42	1.00	0.00	0.00	0.42	0.00
Sat Flow, veh/h				3563	0	1585	3483	3676	0	0	3647	1585
Grp Volume(v), veh/h				654	0	0	795	688	0	0	236	0
Grp Sat Flow(s),veh/h/ln				1781	0	1585	1742	1791	0	0	1777	1585
Q Serve(g_s), s				21.3	0.0	0.0	25.6	0.0	0.0	0.0	4.9	0.0
Cycle Q Clear(g_c), s				21.3	0.0	0.0	25.6	0.0	0.0	0.0	4.9	0.0
Prop In Lane				1.00		1.00	1.00		0.00	0.00		1.00
Lane Grp Cap(c), veh/h				747	0		881	2562	0	0	1510	
V/C Ratio(X)				0.88	0.00		0.90	0.27	0.00	0.00	0.16	
Avail Cap(c_a), veh/h				980	0		1277	2562	0	0	1510	
HCM Platoon Ratio				1.00	1.00	1.00	1.67	1.67	1.00	1.00	1.00	1.00
Upstream Filter(I)				1.00	0.00	0.00	0.90	0.90	0.00	0.00	1.00	0.00
Uniform Delay (d), s/veh				45.9	0.0	0.0	33.3	0.0	0.0	0.0	21.3	0.0
Incr Delay (d2), s/veh				7.2	0.0	0.0	6.1	0.2	0.0	0.0	0.2	0.0
Initial Q Delay(d3), s/veh				0.0	0.0	0.0	0.0	0.0	0.0	0.0	0.0	0.0
%ile BackOfQ(95%),veh/ln				15.3	0.0	0.0	14.3	0.1	0.0	0.0	3.7	0.0
Unsig. Movement Delay, s/veh												
LnGrp Delay(d), s/veh				53.1	0.0	0.0	39.4	0.2	0.0	0.0	21.5	0.0
LnGrp LOS				D			D	A			C	
Approach Vol, veh/h					654			1483			236	
Approach Delay, s/veh					53.1			21.2			21.5	
Approach LOS					D			C			C	
Timer - Assigned Phs		2			5	6		8				
Phs Duration (G+Y+Rc), s		90.3			34.9	55.5		29.7				
Change Period (Y+Rc), s		4.5			4.5	4.5		4.5				
Max Green Setting (Gmax), s		78.0			44.0	29.5		33.0				
Max Q Clear Time (g_c+I1), s		2.0			27.6	6.9		23.3				
Green Ext Time (p_c), s		5.1			2.8	1.3		1.8				

Intersection Summary		
HCM 7th Control Delay, s/veh		30.0
HCM 7th LOS		C

Notes  
 User approved volume balancing among the lanes for turning movement.  
 Unsignalized Delay for [WBR, SBR] is excluded from calculations of the approach delay and intersection delay.

Timings  
 7: Kendrick Castillo Way & C-470 WB On-Ramp/C-470 WB Off-Ramp

2028 Background PM  
 06/10/2025

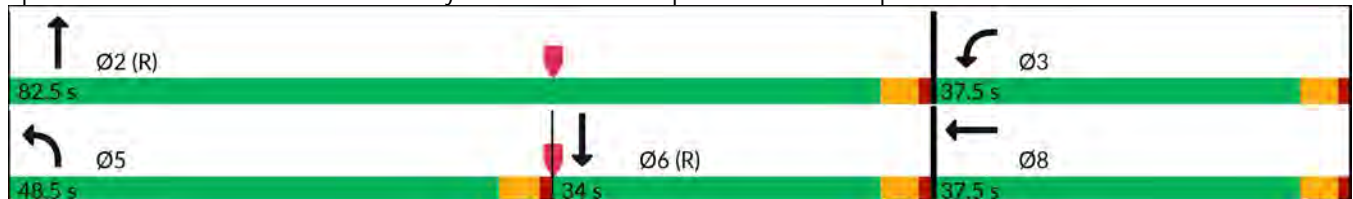


Lane Group	WBL	WBT	WBR	NBL	NBT	SBT	SBR
Lane Configurations	↶	↷	↷	↶↷	↶↷	↶↷	↷
Traffic Volume (vph)	590	1	84	822	445	539	124
Future Volume (vph)	590	1	84	822	445	539	124
Turn Type	Prot	NA	Free	Prot	NA	NA	Free
Protected Phases	3	8		5	2	6	
Permitted Phases			Free				Free
Detector Phase	3	8		5	2	6	
Switch Phase							
Minimum Initial (s)	5.0	5.0		5.0	5.0	5.0	
Minimum Split (s)	9.5	22.5		9.5	22.5	22.5	
Total Split (s)	37.5	37.5		48.5	82.5	34.0	
Total Split (%)	31.3%	31.3%		40.4%	68.8%	28.3%	
Yellow Time (s)	3.5	3.5		3.5	3.5	3.5	
All-Red Time (s)	1.0	1.0		1.0	1.0	1.0	
Lost Time Adjust (s)	0.0	0.0		0.0	0.0	0.0	
Total Lost Time (s)	4.5	4.5		4.5	4.5	4.5	
Lead/Lag				Lead		Lag	
Lead-Lag Optimize?				Yes		Yes	
Recall Mode	None	None		None	C-Max	C-Max	
Act Effct Green (s)	33.0	33.0	120.0	36.8	78.0	36.7	120.0
Actuated g/C Ratio	0.28	0.28	1.00	0.31	0.65	0.31	1.00
v/c Ratio	0.68	0.68	0.06	0.83	0.21	0.53	0.08
Control Delay (s/veh)	47.2	47.3	0.1	71.9	6.5	37.7	0.1
Queue Delay	0.0	0.0	0.0	0.0	0.0	0.0	0.0
Total Delay (s/veh)	47.2	47.3	0.1	71.9	6.5	37.7	0.1
LOS	D	D	A	E	A	D	A
Approach Delay (s/veh)		41.4			48.9	30.7	
Approach LOS		D			D	C	

Intersection Summary

Cycle Length: 120  
 Actuated Cycle Length: 120  
 Offset: 0 (0%), Referenced to phase 2:NBT and 6:SBT, Start of Green  
 Natural Cycle: 70  
 Control Type: Actuated-Coordinated  
 Maximum v/c Ratio: 0.83  
 Intersection Signal Delay (s/veh): 42.3  
 Intersection LOS: D  
 Intersection Capacity Utilization 68.0%  
 ICU Level of Service C  
 Analysis Period (min) 15

Splits and Phases: 7: Kendrick Castillo Way & C-470 WB On-Ramp/C-470 WB Off-Ramp



HCM 7th Signalized Intersection Summary  
 7: Kendrick Castillo Way & C-470 WB On-Ramp/C-470 WB Off-Ramp

2028 Background PM  
 06/10/2025



Movement	EBL	EBT	EBR	WBL	WBT	WBR	NBL	NBT	NBR	SBL	SBT	SBR
Lane Configurations				↖	↖	↖	↖↖	↖↖			↖↖	↖
Traffic Volume (veh/h)	0	0	0	590	1	84	822	445	0	0	539	124
Future Volume (veh/h)	0	0	0	590	1	84	822	445	0	0	539	124
Initial Q (Qb), veh				0	0	0	0	0	0	0	0	0
Lane Width Adj.				1.00	1.00	1.00	1.00	1.00	1.00	1.00	1.00	1.00
Ped-Bike Adj(A_pbT)				1.00		1.00	1.00		1.00	1.00		1.00
Parking Bus, Adj				1.00	1.00	1.00	1.00	1.00	1.00	1.00	1.00	1.00
Work Zone On Approach				No			No				No	
Adj Sat Flow, veh/h/ln				1900	1900	1900	1900	1900	0	0	1900	1900
Adj Flow Rate, veh/h				642	0	0	893	484	0	0	586	0
Peak Hour Factor				0.92	0.92	0.92	0.92	0.92	0.92	0.92	0.92	0.92
Percent Heavy Veh, %				0	0	0	0	0	0	0	0	0
Cap, veh/h				738	0		977	2603	0	0	1463	
Arrive On Green				0.20	0.00	0.00	0.46	1.00	0.00	0.00	0.41	0.00
Sat Flow, veh/h				3619	0	1610	3510	3705	0	0	3705	1610
Grp Volume(v), veh/h				642	0	0	893	484	0	0	586	0
Grp Sat Flow(s),veh/h/ln				1810	0	1610	1755	1805	0	0	1805	1610
Q Serve(g_s), s				20.6	0.0	0.0	28.4	0.0	0.0	0.0	13.8	0.0
Cycle Q Clear(g_c), s				20.6	0.0	0.0	28.4	0.0	0.0	0.0	13.8	0.0
Prop In Lane				1.00		1.00	1.00		0.00	0.00		1.00
Lane Grp Cap(c), veh/h				738	0		977	2603	0	0	1463	
V/C Ratio(X)				0.87	0.00		0.91	0.19	0.00	0.00	0.40	
Avail Cap(c_a), veh/h				995	0		1287	2603	0	0	1463	
HCM Platoon Ratio				1.00	1.00	1.00	1.67	1.67	1.00	1.00	1.00	1.00
Upstream Filter(I)				1.00	0.00	0.00	0.88	0.88	0.00	0.00	1.00	0.00
Uniform Delay (d), s/veh				46.2	0.0	0.0	30.8	0.0	0.0	0.0	25.3	0.0
Incr Delay (d2), s/veh				6.5	0.0	0.0	7.5	0.1	0.0	0.0	0.8	0.0
Initial Q Delay(d3), s/veh				0.0	0.0	0.0	0.0	0.0	0.0	0.0	0.0	0.0
%ile BackOfQ(95%),veh/ln				15.0	0.0	0.0	15.5	0.1	0.0	0.0	9.9	0.0
Unsig. Movement Delay, s/veh												
LnGrp Delay(d), s/veh				52.8	0.0	0.0	38.3	0.1	0.0	0.0	26.1	0.0
LnGrp LOS				D			D	A			C	
Approach Vol, veh/h					642			1377			586	
Approach Delay, s/veh					52.8			24.9			26.1	
Approach LOS					D			C			C	
Timer - Assigned Phs		2			5	6		8				
Phs Duration (G+Y+Rc), s		91.0			37.9	53.1		29.0				
Change Period (Y+Rc), s		4.5			4.5	4.5		4.5				
Max Green Setting (Gmax), s		78.0			44.0	29.5		33.0				
Max Q Clear Time (g_c+I1), s		2.0			30.4	15.8		22.6				
Green Ext Time (p_c), s		3.4			3.0	3.1		1.9				
<b>Intersection Summary</b>												
HCM 7th Control Delay, s/veh					32.0							
HCM 7th LOS					C							
<b>Notes</b>												
User approved volume balancing among the lanes for turning movement.												
Unsignalized Delay for [WBR, SBR] is excluded from calculations of the approach delay and intersection delay.												

Timings  
 7: Kendrick Castillo Way & C-470 WB On-Ramp/C-470 WB Off-Ramp

2028 Total AM  
 02/05/2026

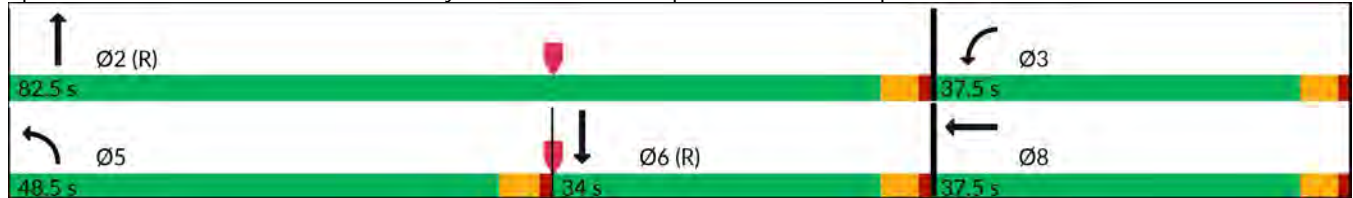


Lane Group	WBL	WBT	WBR	NBL	NBT	SBT	SBR
Lane Configurations	↶	↶	↶	↶↶	↶↶	↶↶	↶
Traffic Volume (vph)	625	2	155	771	659	226	34
Future Volume (vph)	625	2	155	771	659	226	34
Turn Type	Prot	NA	Free	Prot	NA	NA	Free
Protected Phases	3	8		5	2	6	
Permitted Phases			Free				Free
Detector Phase	3	8		5	2	6	
Switch Phase							
Minimum Initial (s)	5.0	5.0		5.0	5.0	5.0	
Minimum Split (s)	9.5	22.5		9.5	22.5	22.5	
Total Split (s)	37.5	37.5		48.5	82.5	34.0	
Total Split (%)	31.3%	31.3%		40.4%	68.8%	28.3%	
Yellow Time (s)	3.5	3.5		3.5	3.5	3.5	
All-Red Time (s)	1.0	1.0		1.0	1.0	1.0	
Lost Time Adjust (s)	0.0	0.0		0.0	0.0	0.0	
Total Lost Time (s)	4.5	4.5		4.5	4.5	4.5	
Lead/Lag				Lead		Lag	
Lead-Lag Optimize?				Yes		Yes	
Recall Mode	None	None		None	C-Max	C-Max	

Intersection Summary

Cycle Length: 120  
 Actuated Cycle Length: 120  
 Offset: 0 (0%), Referenced to phase 2:NBT and 6:SBT, Start of Green  
 Natural Cycle: 65  
 Control Type: Actuated-Coordinated

Splits and Phases: 7: Kendrick Castillo Way & C-470 WB On-Ramp/C-470 WB Off-Ramp



HCM 7th Signalized Intersection Summary  
 7: Kendrick Castillo Way & C-470 WB On-Ramp/C-470 WB Off-Ramp

2028 Total AM  
 02/05/2026



Movement	EBL	EBT	EBR	WBL	WBT	WBR	NBL	NBT	NBR	SBL	SBT	SBR
Lane Configurations				↶	↷	↶	↶↷	↶↷			↶↷	↶
Traffic Volume (veh/h)	0	0	0	625	2	155	771	659	0	0	226	34
Future Volume (veh/h)	0	0	0	625	2	155	771	659	0	0	226	34
Initial Q (Qb), veh				0	0	0	0	0	0	0	0	0
Lane Width Adj.				1.00	1.00	1.00	1.00	1.00	1.00	1.00	1.00	1.00
Ped-Bike Adj(A_pbT)				1.00		1.00	1.00		1.00	1.00		1.00
Parking Bus, Adj				1.00	1.00	1.00	1.00	1.00	1.00	1.00	1.00	1.00
Work Zone On Approach				No			No			No		
Adj Sat Flow, veh/h/ln				1870	1870	1870	1885	1885	0	0	1870	1870
Adj Flow Rate, veh/h				659	0	0	812	694	0	0	238	0
Peak Hour Factor				0.95	0.95	0.95	0.95	0.95	0.95	0.95	0.95	0.95
Percent Heavy Veh, %				2	2	2	1	1	0	0	2	2
Cap, veh/h				752	0		898	2557	0	0	1488	
Arrive On Green				0.21	0.00	0.00	0.43	1.00	0.00	0.00	0.42	0.00
Sat Flow, veh/h				3563	0	1585	3483	3676	0	0	3647	1585
Grp Volume(v), veh/h				659	0	0	812	694	0	0	238	0
Grp Sat Flow(s),veh/h/ln				1781	0	1585	1742	1791	0	0	1777	1585
Q Serve(g_s), s				21.5	0.0	0.0	26.1	0.0	0.0	0.0	5.0	0.0
Cycle Q Clear(g_c), s				21.5	0.0	0.0	26.1	0.0	0.0	0.0	5.0	0.0
Prop In Lane				1.00		1.00	1.00		0.00	0.00		1.00
Lane Grp Cap(c), veh/h				752	0		898	2557	0	0	1488	
V/C Ratio(X)				0.88	0.00		0.90	0.27	0.00	0.00	0.16	
Avail Cap(c_a), veh/h				980	0		1277	2557	0	0	1488	
HCM Platoon Ratio				1.00	1.00	1.00	1.67	1.67	1.00	1.00	1.00	1.00
Upstream Filter(I)				1.00	0.00	0.00	0.89	0.89	0.00	0.00	1.00	0.00
Uniform Delay (d), s/veh				45.8	0.0	0.0	32.8	0.0	0.0	0.0	21.7	0.0
Incr Delay (d2), s/veh				7.3	0.0	0.0	6.3	0.2	0.0	0.0	0.2	0.0
Initial Q Delay(d3), s/veh				0.0	0.0	0.0	0.0	0.0	0.0	0.0	0.0	0.0
%ile BackOfQ(95%),veh/ln				15.4	0.0	0.0	14.5	0.1	0.0	0.0	3.8	0.0
Unsig. Movement Delay, s/veh												
LnGrp Delay(d), s/veh				53.1	0.0	0.0	39.1	0.2	0.0	0.0	22.0	0.0
LnGrp LOS				D			D	A			C	
Approach Vol, veh/h					659			1506			238	
Approach Delay, s/veh					53.1			21.2			22.0	
Approach LOS					D			C			C	
Timer - Assigned Phs		2			5	6		8				
Phs Duration (G+Y+Rc), s		90.2			35.4	54.7		29.8				
Change Period (Y+Rc), s		4.5			4.5	4.5		4.5				
Max Green Setting (Gmax), s		78.0			44.0	29.5		33.0				
Max Q Clear Time (g_c+I1), s		2.0			28.1	7.0		23.5				
Green Ext Time (p_c), s		5.2			2.8	1.3		1.8				
<b>Intersection Summary</b>												
HCM 7th Control Delay, s/veh											30.0	
HCM 7th LOS											C	
<b>Notes</b>												
User approved volume balancing among the lanes for turning movement.												
Unsignalized Delay for [WBR, SBR] is excluded from calculations of the approach delay and intersection delay.												

Timings  
 7: Kendrick Castillo Way & C-470 WB On-Ramp/C-470 WB Off-Ramp

2028 Total PM  
 02/05/2026

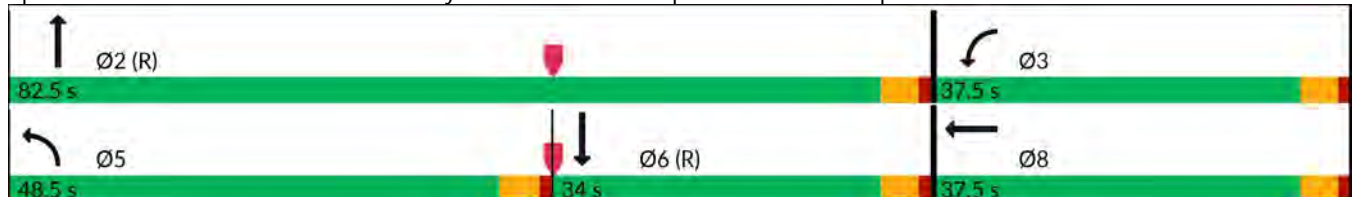


Lane Group	WBL	WBT	WBR	NBL	NBT	SBT	SBR
Lane Configurations	↶	↶	↶	↶↶	↶↶	↶↶	↶
Traffic Volume (vph)	606	1	84	832	448	544	124
Future Volume (vph)	606	1	84	832	448	544	124
Turn Type	Prot	NA	Free	Prot	NA	NA	Free
Protected Phases	3	8		5	2	6	
Permitted Phases			Free				Free
Detector Phase	3	8		5	2	6	
Switch Phase							
Minimum Initial (s)	5.0	5.0		5.0	5.0	5.0	
Minimum Split (s)	9.5	22.5		9.5	22.5	22.5	
Total Split (s)	37.5	37.5		48.5	82.5	34.0	
Total Split (%)	31.3%	31.3%		40.4%	68.8%	28.3%	
Yellow Time (s)	3.5	3.5		3.5	3.5	3.5	
All-Red Time (s)	1.0	1.0		1.0	1.0	1.0	
Lost Time Adjust (s)	0.0	0.0		0.0	0.0	0.0	
Total Lost Time (s)	4.5	4.5		4.5	4.5	4.5	
Lead/Lag				Lead		Lag	
Lead-Lag Optimize?				Yes		Yes	
Recall Mode	None	None		None	C-Max	C-Max	

Intersection Summary

Cycle Length: 120  
 Actuated Cycle Length: 120  
 Offset: 0 (0%), Referenced to phase 2:NBT and 6:SBT, Start of Green  
 Natural Cycle: 70  
 Control Type: Actuated-Coordinated

Splits and Phases: 7: Kendrick Castillo Way & C-470 WB On-Ramp/C-470 WB Off-Ramp



HCM 7th Signalized Intersection Summary  
 7: Kendrick Castillo Way & C-470 WB On-Ramp/C-470 WB Off-Ramp

2028 Total PM  
 02/05/2026



Movement	EBL	EBT	EBR	WBL	WBT	WBR	NBL	NBT	NBR	SBL	SBT	SBR
Lane Configurations				↖	↖	↖	↖↖	↖↖			↖↖	↖
Traffic Volume (veh/h)	0	0	0	606	1	84	832	448	0	0	544	124
Future Volume (veh/h)	0	0	0	606	1	84	832	448	0	0	544	124
Initial Q (Qb), veh				0	0	0	0	0	0	0	0	0
Lane Width Adj.				1.00	1.00	1.00	1.00	1.00	1.00	1.00	1.00	1.00
Ped-Bike Adj(A_pbT)				1.00		1.00	1.00		1.00	1.00		1.00
Parking Bus, Adj				1.00	1.00	1.00	1.00	1.00	1.00	1.00	1.00	1.00
Work Zone On Approach				No			No			No		
Adj Sat Flow, veh/h/ln				1900	1900	1900	1900	1900	0	0	1900	1900
Adj Flow Rate, veh/h				660	0	0	904	487	0	0	591	0
Peak Hour Factor				0.92	0.92	0.92	0.92	0.92	0.92	0.92	0.92	0.92
Percent Heavy Veh, %				0	0	0	0	0	0	0	0	0
Cap, veh/h				755	0		988	2586	0	0	1435	
Arrive On Green				0.21	0.00	0.00	0.47	1.00	0.00	0.00	0.40	0.00
Sat Flow, veh/h				3619	0	1610	3510	3705	0	0	3705	1610
Grp Volume(v), veh/h				660	0	0	904	487	0	0	591	0
Grp Sat Flow(s),veh/h/ln				1810	0	1610	1755	1805	0	0	1805	1610
Q Serve(g_s), s				21.2	0.0	0.0	28.7	0.0	0.0	0.0	14.2	0.0
Cycle Q Clear(g_c), s				21.2	0.0	0.0	28.7	0.0	0.0	0.0	14.2	0.0
Prop In Lane				1.00		1.00	1.00		0.00	0.00		1.00
Lane Grp Cap(c), veh/h				755	0		988	2586	0	0	1435	
V/C Ratio(X)				0.87	0.00		0.92	0.19	0.00	0.00	0.41	
Avail Cap(c_a), veh/h				995	0		1287	2586	0	0	1435	
HCM Platoon Ratio				1.00	1.00	1.00	1.67	1.67	1.00	1.00	1.00	1.00
Upstream Filter(I)				1.00	0.00	0.00	0.88	0.88	0.00	0.00	1.00	0.00
Uniform Delay (d), s/veh				46.0	0.0	0.0	30.5	0.0	0.0	0.0	26.0	0.0
Incr Delay (d2), s/veh				6.9	0.0	0.0	7.7	0.1	0.0	0.0	0.9	0.0
Initial Q Delay(d3), s/veh				0.0	0.0	0.0	0.0	0.0	0.0	0.0	0.0	0.0
%ile BackOfQ(95%),veh/ln				15.3	0.0	0.0	15.7	0.1	0.0	0.0	10.1	0.0
Unsig. Movement Delay, s/veh												
LnGrp Delay(d), s/veh				52.9	0.0	0.0	38.2	0.1	0.0	0.0	26.9	0.0
LnGrp LOS				D			D	A			C	
Approach Vol, veh/h					660			1391			591	
Approach Delay, s/veh					52.9			24.9			26.9	
Approach LOS					D			C			C	
Timer - Assigned Phs		2			5	6		8				
Phs Duration (G+Y+Rc), s		90.5			38.3	52.2		29.5				
Change Period (Y+Rc), s		4.5			4.5	4.5		4.5				
Max Green Setting (Gmax), s		78.0			44.0	29.5		33.0				
Max Q Clear Time (g_c+I1), s		2.0			30.7	16.2		23.2				
Green Ext Time (p_c), s		3.4			3.0	3.1		1.9				

Intersection Summary		
HCM 7th Control Delay, s/veh		32.3
HCM 7th LOS		C

Notes  
 User approved volume balancing among the lanes for turning movement.  
 Unsignalized Delay for [WBR, SBR] is excluded from calculations of the approach delay and intersection delay.



HCM 7th Signalized Intersection Summary  
 7: Kendrick Castillo Way & C-470 WB On-Ramp/C-470 WB Off-Ramp

2045 Background AM  
 06/09/2025



Movement	EBL	EBT	EBR	WBL	WBT	WBR	NBL	NBT	NBR	SBL	SBT	SBR
Lane Configurations				↶	↷	↶	↶↷	↶↷			↶↷	↶
Traffic Volume (veh/h)	0	0	0	734	2	183	894	775	0	0	264	40
Future Volume (veh/h)	0	0	0	734	2	183	894	775	0	0	264	40
Initial Q (Qb), veh				0	0	0	0	0	0	0	0	0
Lane Width Adj.				1.00	1.00	1.00	1.00	1.00	1.00	1.00	1.00	1.00
Ped-Bike Adj(A_pbT)				1.00		1.00	1.00		1.00	1.00		1.00
Parking Bus, Adj				1.00	1.00	1.00	1.00	1.00	1.00	1.00	1.00	1.00
Work Zone On Approach				No			No			No		
Adj Sat Flow, veh/h/ln				1870	1870	1870	1885	1885	0	0	1870	1870
Adj Flow Rate, veh/h				774	0	0	941	816	0	0	278	0
Peak Hour Factor				0.95	0.95	0.95	0.95	0.95	0.95	0.95	0.95	0.95
Percent Heavy Veh, %				2	2	2	1	1	0	0	2	2
Cap, veh/h				858	0		1021	2450	0	0	1256	
Arrive On Green				0.24	0.00	0.00	0.49	1.00	0.00	0.00	0.35	0.00
Sat Flow, veh/h				3563	0	1585	3483	3676	0	0	3647	1585
Grp Volume(v), veh/h				774	0	0	941	816	0	0	278	0
Grp Sat Flow(s),veh/h/ln				1781	0	1585	1742	1791	0	0	1777	1585
Q Serve(g_s), s				25.3	0.0	0.0	30.2	0.0	0.0	0.0	6.6	0.0
Cycle Q Clear(g_c), s				25.3	0.0	0.0	30.2	0.0	0.0	0.0	6.6	0.0
Prop In Lane				1.00		1.00	1.00		0.00	0.00		1.00
Lane Grp Cap(c), veh/h				858	0		1021	2450	0	0	1256	
V/C Ratio(X)				0.90	0.00		0.92	0.33	0.00	0.00	0.22	
Avail Cap(c_a), veh/h				980	0		1277	2450	0	0	1256	
HCM Platoon Ratio				1.00	1.00	1.00	1.67	1.67	1.00	1.00	1.00	1.00
Upstream Filter(I)				1.00	0.00	0.00	0.76	0.76	0.00	0.00	1.00	0.00
Uniform Delay (d), s/veh				44.2	0.0	0.0	29.3	0.0	0.0	0.0	27.2	0.0
Incr Delay (d2), s/veh				10.4	0.0	0.0	7.6	0.3	0.0	0.0	0.4	0.0
Initial Q Delay(d3), s/veh				0.0	0.0	0.0	0.0	0.0	0.0	0.0	0.0	0.0
%ile BackOfQ(95%),veh/ln				17.9	0.0	0.0	15.6	0.2	0.0	0.0	5.1	0.0
Unsig. Movement Delay, s/veh												
LnGrp Delay(d), s/veh				54.6	0.0	0.0	37.0	0.3	0.0	0.0	27.6	0.0
LnGrp LOS				D			D	A			C	
Approach Vol, veh/h					774			1757			278	
Approach Delay, s/veh					54.6			19.9			27.6	
Approach LOS					D			B			C	
Timer - Assigned Phs		2			5	6		8				
Phs Duration (G+Y+Rc), s		86.6			39.7	46.9		33.4				
Change Period (Y+Rc), s		4.5			4.5	4.5		4.5				
Max Green Setting (Gmax), s		78.0			44.0	29.5		33.0				
Max Q Clear Time (g_c+I1), s		2.0			32.2	8.6		27.3				
Green Ext Time (p_c), s		6.4			3.0	1.6		1.6				

Intersection Summary		
HCM 7th Control Delay, s/veh		30.2
HCM 7th LOS		C

Notes  
 User approved volume balancing among the lanes for turning movement.  
 Unsignalized Delay for [WBR, SBR] is excluded from calculations of the approach delay and intersection delay.



HCM 7th Signalized Intersection Summary  
 7: Kendrick Castillo Way & C-470 WB On-Ramp/C-470 WB Off-Ramp

2045 Background PM  
 06/09/2025



Movement	EBL	EBT	EBR	WBL	WBT	WBR	NBL	NBT	NBR	SBL	SBT	SBR
Lane Configurations				↶	↷	↶	↶↷	↶↷			↶↷	↶
Traffic Volume (veh/h)	0	0	0	697	1	100	974	527	0	0	637	146
Future Volume (veh/h)	0	0	0	697	1	100	974	527	0	0	637	146
Initial Q (Qb), veh				0	0	0	0	0	0	0	0	0
Lane Width Adj.				1.00	1.00	1.00	1.00	1.00	1.00	1.00	1.00	1.00
Ped-Bike Adj(A_pbT)				1.00		1.00	1.00		1.00	1.00		1.00
Parking Bus, Adj				1.00	1.00	1.00	1.00	1.00	1.00	1.00	1.00	1.00
Work Zone On Approach				No			No				No	
Adj Sat Flow, veh/h/ln				1900	1900	1900	1900	1900	0	0	1900	1900
Adj Flow Rate, veh/h				759	0	0	1059	573	0	0	692	0
Peak Hour Factor				0.92	0.92	0.92	0.92	0.92	0.92	0.92	0.92	0.92
Percent Heavy Veh, %				0	0	0	0	0	0	0	0	0
Cap, veh/h				848	0		1130	2493	0	0	1196	
Arrive On Green				0.23	0.00	0.00	0.54	1.00	0.00	0.00	0.33	0.00
Sat Flow, veh/h				3619	0	1610	3510	3705	0	0	3705	1610
Grp Volume(v), veh/h				759	0	0	1059	573	0	0	692	0
Grp Sat Flow(s),veh/h/ln				1810	0	1610	1755	1805	0	0	1805	1610
Q Serve(g_s), s				24.4	0.0	0.0	33.7	0.0	0.0	0.0	19.0	0.0
Cycle Q Clear(g_c), s				24.4	0.0	0.0	33.7	0.0	0.0	0.0	19.0	0.0
Prop In Lane				1.00		1.00	1.00		0.00	0.00		1.00
Lane Grp Cap(c), veh/h				848	0		1130	2493	0	0	1196	
V/C Ratio(X)				0.89	0.00		0.94	0.23	0.00	0.00	0.58	
Avail Cap(c_a), veh/h				995	0		1287	2493	0	0	1196	
HCM Platoon Ratio				1.00	1.00	1.00	1.67	1.67	1.00	1.00	1.00	1.00
Upstream Filter(I)				1.00	0.00	0.00	0.80	0.80	0.00	0.00	1.00	0.00
Uniform Delay (d), s/veh				44.5	0.0	0.0	26.6	0.0	0.0	0.0	33.2	0.0
Incr Delay (d2), s/veh				9.4	0.0	0.0	10.1	0.2	0.0	0.0	2.0	0.0
Initial Q Delay(d3), s/veh				0.0	0.0	0.0	0.0	0.0	0.0	0.0	0.0	0.0
%ile BackOfQ(95%),veh/ln				17.5	0.0	0.0	17.2	0.1	0.0	0.0	13.2	0.0
Unsig. Movement Delay, s/veh												
LnGrp Delay(d), s/veh				53.9	0.0	0.0	36.8	0.2	0.0	0.0	35.2	0.0
LnGrp LOS				D			D	A			D	
Approach Vol, veh/h					759			1632			692	
Approach Delay, s/veh					53.9			23.9			35.2	
Approach LOS					D			C			D	
Timer - Assigned Phs		2			5	6		8				
Phs Duration (G+Y+Rc), s		87.4			43.1	44.3		32.6				
Change Period (Y+Rc), s		4.5			4.5	4.5		4.5				
Max Green Setting (Gmax), s		78.0			44.0	29.5		33.0				
Max Q Clear Time (g_c+I1), s		2.0			35.7	21.0		26.4				
Green Ext Time (p_c), s		4.1			2.9	2.8		1.8				

Intersection Summary		
HCM 7th Control Delay, s/veh		33.8
HCM 7th LOS		C

Notes  
 User approved volume balancing among the lanes for turning movement.  
 Unsignalized Delay for [WBR, SBR] is excluded from calculations of the approach delay and intersection delay.

Timings  
 7: Kendrick Castillo Way & C-470 WB On-Ramp/C-470 WB Off-Ramp

2045 Total AM  
 02/05/2026

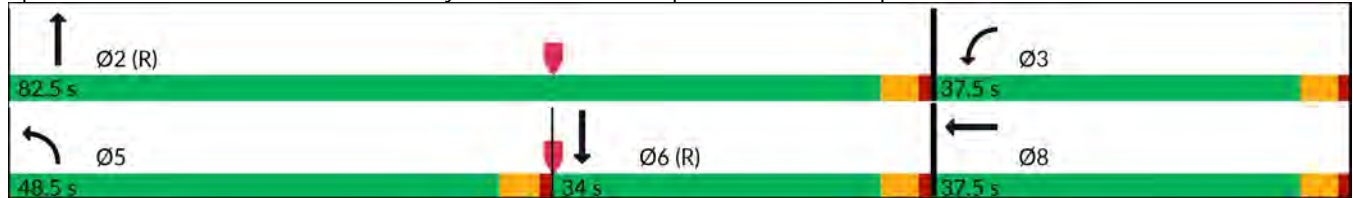


Lane Group	WBL	WBT	WBR	NBL	NBT	SBT	SBR
Lane Configurations	↶	↶	↶	↶↶	↶↶	↶↶	↶
Traffic Volume (vph)	739	2	183	910	780	266	40
Future Volume (vph)	739	2	183	910	780	266	40
Turn Type	Prot	NA	Free	Prot	NA	NA	Free
Protected Phases	3	8		5	2	6	
Permitted Phases			Free				Free
Detector Phase	3	8		5	2	6	
Switch Phase							
Minimum Initial (s)	5.0	5.0		5.0	5.0	5.0	
Minimum Split (s)	9.5	22.5		9.5	22.5	22.5	
Total Split (s)	37.5	37.5		48.5	82.5	34.0	
Total Split (%)	31.3%	31.3%		40.4%	68.8%	28.3%	
Yellow Time (s)	3.5	3.5		3.5	3.5	3.5	
All-Red Time (s)	1.0	1.0		1.0	1.0	1.0	
Lost Time Adjust (s)	0.0	0.0		0.0	0.0	0.0	
Total Lost Time (s)	4.5	4.5		4.5	4.5	4.5	
Lead/Lag				Lead		Lag	
Lead-Lag Optimize?				Yes		Yes	
Recall Mode	None	None		None	C-Max	C-Max	

Intersection Summary

Cycle Length: 120  
 Actuated Cycle Length: 120  
 Offset: 0 (0%), Referenced to phase 2:NBT and 6:SBT, Start of Green  
 Natural Cycle: 80  
 Control Type: Actuated-Coordinated

Splits and Phases: 7: Kendrick Castillo Way & C-470 WB On-Ramp/C-470 WB Off-Ramp



HCM 7th Signalized Intersection Summary  
 7: Kendrick Castillo Way & C-470 WB On-Ramp/C-470 WB Off-Ramp

2045 Total AM  
 02/05/2026



Movement	EBL	EBT	EBR	WBL	WBT	WBR	NBL	NBT	NBR	SBL	SBT	SBR
Lane Configurations				↶	↷	↶	↶↷	↶↷			↶↷	↶
Traffic Volume (veh/h)	0	0	0	739	2	183	910	780	0	0	266	40
Future Volume (veh/h)	0	0	0	739	2	183	910	780	0	0	266	40
Initial Q (Qb), veh				0	0	0	0	0	0	0	0	0
Lane Width Adj.				1.00	1.00	1.00	1.00	1.00	1.00	1.00	1.00	1.00
Ped-Bike Adj(A_pbT)				1.00		1.00	1.00		1.00	1.00		1.00
Parking Bus, Adj				1.00	1.00	1.00	1.00	1.00	1.00	1.00	1.00	1.00
Work Zone On Approach				No			No			No		
Adj Sat Flow, veh/h/ln				1870	1870	1870	1885	1885	0	0	1870	1870
Adj Flow Rate, veh/h				779	0	0	958	821	0	0	280	0
Peak Hour Factor				0.95	0.95	0.95	0.95	0.95	0.95	0.95	0.95	0.95
Percent Heavy Veh, %				2	2	2	1	1	0	0	2	2
Cap, veh/h				863	0		1037	2446	0	0	1235	
Arrive On Green				0.24	0.00	0.00	0.50	1.00	0.00	0.00	0.35	0.00
Sat Flow, veh/h				3563	0	1585	3483	3676	0	0	3647	1585
Grp Volume(v), veh/h				779	0	0	958	821	0	0	280	0
Grp Sat Flow(s),veh/h/ln				1781	0	1585	1742	1791	0	0	1777	1585
Q Serve(g_s), s				25.4	0.0	0.0	30.7	0.0	0.0	0.0	6.7	0.0
Cycle Q Clear(g_c), s				25.4	0.0	0.0	30.7	0.0	0.0	0.0	6.7	0.0
Prop In Lane				1.00		1.00	1.00		0.00	0.00		1.00
Lane Grp Cap(c), veh/h				863	0		1037	2446	0	0	1235	
V/C Ratio(X)				0.90	0.00		0.92	0.34	0.00	0.00	0.23	
Avail Cap(c_a), veh/h				980	0		1277	2446	0	0	1235	
HCM Platoon Ratio				1.00	1.00	1.00	1.67	1.67	1.00	1.00	1.00	1.00
Upstream Filter(I)				1.00	0.00	0.00	0.75	0.75	0.00	0.00	1.00	0.00
Uniform Delay (d), s/veh				44.1	0.0	0.0	28.9	0.0	0.0	0.0	27.7	0.0
Incr Delay (d2), s/veh				10.6	0.0	0.0	7.8	0.3	0.0	0.0	0.4	0.0
Initial Q Delay(d3), s/veh				0.0	0.0	0.0	0.0	0.0	0.0	0.0	0.0	0.0
%ile BackOfQ(95%),veh/ln				18.1	0.0	0.0	15.8	0.2	0.0	0.0	5.2	0.0
Unsig. Movement Delay, s/veh												
LnGrp Delay(d), s/veh				54.7	0.0	0.0	36.7	0.3	0.0	0.0	28.1	0.0
LnGrp LOS				D			D	A			C	
Approach Vol, veh/h					779			1779			280	
Approach Delay, s/veh					54.7			19.9			28.1	
Approach LOS					D			B			C	
Timer - Assigned Phs		2			5	6		8				
Phs Duration (G+Y+Rc), s		86.4			40.2	46.2		33.6				
Change Period (Y+Rc), s		4.5			4.5	4.5		4.5				
Max Green Setting (Gmax), s		78.0			44.0	29.5		33.0				
Max Q Clear Time (g_c+I1), s		2.0			32.7	8.7		27.4				
Green Ext Time (p_c), s		6.5			3.0	1.6		1.6				

Intersection Summary		
HCM 7th Control Delay, s/veh		30.3
HCM 7th LOS		C

Notes  
 User approved volume balancing among the lanes for turning movement.  
 Unsignalized Delay for [WBR, SBR] is excluded from calculations of the approach delay and intersection delay.

Timings  
 7: Kendrick Castillo Way & C-470 WB On-Ramp/C-470 WB Off-Ramp

2045 Total PM  
 02/05/2026

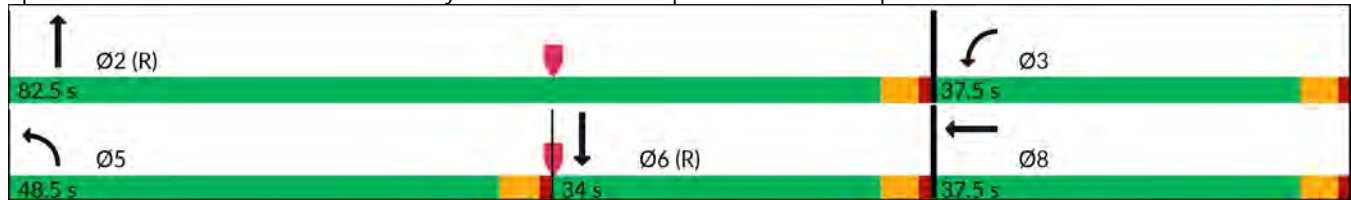


Lane Group	WBL	WBT	WBR	NBL	NBT	SBT	SBR
Lane Configurations	↶	↶	↶	↶↶	↶↶	↶↶	↶
Traffic Volume (vph)	713	1	100	984	530	642	146
Future Volume (vph)	713	1	100	984	530	642	146
Turn Type	Prot	NA	Free	Prot	NA	NA	Free
Protected Phases	3	8		5	2	6	
Permitted Phases			Free				Free
Detector Phase	3	8		5	2	6	
Switch Phase							
Minimum Initial (s)	5.0	5.0		5.0	5.0	5.0	
Minimum Split (s)	9.5	22.5		9.5	22.5	22.5	
Total Split (s)	37.5	37.5		48.5	82.5	34.0	
Total Split (%)	31.3%	31.3%		40.4%	68.8%	28.3%	
Yellow Time (s)	3.5	3.5		3.5	3.5	3.5	
All-Red Time (s)	1.0	1.0		1.0	1.0	1.0	
Lost Time Adjust (s)	0.0	0.0		0.0	0.0	0.0	
Total Lost Time (s)	4.5	4.5		4.5	4.5	4.5	
Lead/Lag				Lead		Lag	
Lead-Lag Optimize?				Yes		Yes	
Recall Mode	None	None		None	C-Max	C-Max	

Intersection Summary

Cycle Length: 120  
 Actuated Cycle Length: 120  
 Offset: 0 (0%), Referenced to phase 2:NBT and 6:SBT, Start of Green  
 Natural Cycle: 80  
 Control Type: Actuated-Coordinated

Splits and Phases: 7: Kendrick Castillo Way & C-470 WB On-Ramp/C-470 WB Off-Ramp



HCM 7th Signalized Intersection Summary  
 7: Kendrick Castillo Way & C-470 WB On-Ramp/C-470 WB Off-Ramp

2045 Total PM  
 02/05/2026



Movement	EBL	EBT	EBR	WBL	WBT	WBR	NBL	NBT	NBR	SBL	SBT	SBR
Lane Configurations				↶	↶	↶	↶↶	↶↶			↶↶	↶
Traffic Volume (veh/h)	0	0	0	713	1	100	984	530	0	0	642	146
Future Volume (veh/h)	0	0	0	713	1	100	984	530	0	0	642	146
Initial Q (Qb), veh				0	0	0	0	0	0	0	0	0
Lane Width Adj.				1.00	1.00	1.00	1.00	1.00	1.00	1.00	1.00	1.00
Ped-Bike Adj(A_pbT)				1.00		1.00	1.00		1.00	1.00		1.00
Parking Bus, Adj				1.00	1.00	1.00	1.00	1.00	1.00	1.00	1.00	1.00
Work Zone On Approach				No			No				No	
Adj Sat Flow, veh/h/ln				1900	1900	1900	1900	1900	0	0	1900	1900
Adj Flow Rate, veh/h				776	0	0	1070	576	0	0	698	0
Peak Hour Factor				0.92	0.92	0.92	0.92	0.92	0.92	0.92	0.92	0.92
Percent Heavy Veh, %				0	0	0	0	0	0	0	0	0
Cap, veh/h				864	0		1139	2478	0	0	1171	
Arrive On Green				0.24	0.00	0.00	0.54	1.00	0.00	0.00	0.32	0.00
Sat Flow, veh/h				3619	0	1610	3510	3705	0	0	3705	1610
Grp Volume(v), veh/h				776	0	0	1070	576	0	0	698	0
Grp Sat Flow(s),veh/h/ln				1810	0	1610	1755	1805	0	0	1805	1610
Q Serve(g_s), s				24.9	0.0	0.0	34.1	0.0	0.0	0.0	19.4	0.0
Cycle Q Clear(g_c), s				24.9	0.0	0.0	34.1	0.0	0.0	0.0	19.4	0.0
Prop In Lane				1.00		1.00	1.00		0.00	0.00		1.00
Lane Grp Cap(c), veh/h				864	0		1139	2478	0	0	1171	
V/C Ratio(X)				0.90	0.00		0.94	0.23	0.00	0.00	0.60	
Avail Cap(c_a), veh/h				995	0		1287	2478	0	0	1171	
HCM Platoon Ratio				1.00	1.00	1.00	1.67	1.67	1.00	1.00	1.00	1.00
Upstream Filter(I)				1.00	0.00	0.00	0.80	0.80	0.00	0.00	1.00	0.00
Uniform Delay (d), s/veh				44.3	0.0	0.0	26.4	0.0	0.0	0.0	34.0	0.0
Incr Delay (d2), s/veh				9.9	0.0	0.0	10.4	0.2	0.0	0.0	2.2	0.0
Initial Q Delay(d3), s/veh				0.0	0.0	0.0	0.0	0.0	0.0	0.0	0.0	0.0
%ile BackOfQ(95%),veh/ln				17.9	0.0	0.0	17.3	0.1	0.0	0.0	13.5	0.0
Unsig. Movement Delay, s/veh												
LnGrp Delay(d), s/veh				54.2	0.0	0.0	36.8	0.2	0.0	0.0	36.2	0.0
LnGrp LOS				D			D	A			D	
Approach Vol, veh/h					776			1646			698	
Approach Delay, s/veh					54.2			24.0			36.2	
Approach LOS					D			C			D	
Timer - Assigned Phs		2			5	6		8				
Phs Duration (G+Y+Rc), s		86.9			43.4	43.4		33.1				
Change Period (Y+Rc), s		4.5			4.5	4.5		4.5				
Max Green Setting (Gmax), s		78.0			44.0	29.5		33.0				
Max Q Clear Time (g_c+I1), s		2.0			36.1	21.4		26.9				
Green Ext Time (p_c), s		4.1			2.8	2.7		1.7				

Intersection Summary		
HCM 7th Control Delay, s/veh		34.2
HCM 7th LOS		C

Notes  
 User approved volume balancing among the lanes for turning movement.  
 Unsignalized Delay for [WBR, SBR] is excluded from calculations of the approach delay and intersection delay.

Intersection												
Int Delay, s/veh	5											
Movement	EBL	EBT	EBR	WBL	WBT	WBR	NBL	NBT	NBR	SBL	SBT	SBR
Lane Configurations		+			+		↑	↑		↑	↑	
Traffic Vol, veh/h	2	0	14	65	0	4	4	21	12	0	40	1
Future Vol, veh/h	2	0	14	65	0	4	4	21	12	0	40	1
Conflicting Peds, #/hr	0	0	0	0	0	0	0	0	0	0	0	0
Sign Control	Stop	Stop	Stop	Stop	Stop	Stop	Free	Free	Free	Free	Free	Free
RT Channelized	-	-	None	-	-	None	-	-	None	-	-	None
Storage Length	-	-	-	-	-	-	0	-	-	0	-	-
Veh in Median Storage, #	-	0	-	-	0	-	-	0	-	-	0	-
Grade, %	-	0	-	-	0	-	-	0	-	-	0	-
Peak Hour Factor	92	92	92	92	92	92	92	92	92	92	92	92
Heavy Vehicles, %	2	2	2	2	2	2	2	2	2	2	2	2
Mvmt Flow	2	0	15	71	0	4	4	23	13	0	43	1

Major/Minor	Minor2		Minor1		Major1		Major2					
Conflicting Flow All	76	89	44	82	83	29	45	0	0	36	0	0
Stage 1	44	44	-	38	38	-	-	-	-	-	-	-
Stage 2	32	45	-	43	45	-	-	-	-	-	-	-
Critical Hdwy	7.12	6.52	6.22	7.12	6.52	6.22	4.12	-	-	4.12	-	-
Critical Hdwy Stg 1	6.12	5.52	-	6.12	5.52	-	-	-	-	-	-	-
Critical Hdwy Stg 2	6.12	5.52	-	6.12	5.52	-	-	-	-	-	-	-
Follow-up Hdwy	3.518	4.018	3.318	3.518	4.018	3.318	2.218	-	-	2.218	-	-
Pot Cap-1 Maneuver	914	802	1026	906	808	1045	1564	-	-	1575	-	-
Stage 1	970	858	-	977	863	-	-	-	-	-	-	-
Stage 2	985	858	-	971	858	-	-	-	-	-	-	-
Platoon blocked, %								-	-	-	-	-
Mov Cap-1 Maneuver	908	799	1026	890	805	1045	1564	-	-	1575	-	-
Mov Cap-2 Maneuver	908	799	-	890	805	-	-	-	-	-	-	-
Stage 1	970	858	-	974	861	-	-	-	-	-	-	-
Stage 2	978	855	-	956	858	-	-	-	-	-	-	-

Approach	EB		WB		NB		SB	
HCM Ctrl Dly, s/v	8.63		9.37		0.79		0	
HCM LOS	A		A					

Minor Lane/Major Mvmt	NBL	NBT	NBR	EBLn1WBLn1	SBL	SBT	SBR
Capacity (veh/h)	1564	-	-	1010	898	1575	-
HCM Lane V/C Ratio	0.003	-	-	0.017	0.084	-	-
HCM Ctrl Dly (s/v)	7.3	-	-	8.6	9.4	0	-
HCM Lane LOS	A	-	-	A	A	A	-
HCM 95th %tile Q(veh)	0	-	-	0.1	0.3	0	-

Intersection												
Int Delay, s/veh	4.9											
Movement	EBL	EBT	EBR	WBL	WBT	WBR	NBL	NBT	NBR	SBL	SBT	SBR
Lane Configurations		+			+		↑	↑		↑	↑	
Traffic Vol, veh/h	1	0	9	41	0	3	14	9	36	1	6	2
Future Vol, veh/h	1	0	9	41	0	3	14	9	36	1	6	2
Conflicting Peds, #/hr	0	0	0	0	0	0	0	0	0	0	0	0
Sign Control	Stop	Stop	Stop	Stop	Stop	Stop	Free	Free	Free	Free	Free	Free
RT Channelized	-	-	None	-	-	None	-	-	None	-	-	None
Storage Length	-	-	-	-	-	-	0	-	-	0	-	-
Veh in Median Storage, #	-	0	-	-	0	-	-	0	-	-	0	-
Grade, %	-	0	-	-	0	-	-	0	-	-	0	-
Peak Hour Factor	92	92	92	92	92	92	92	92	92	92	92	92
Heavy Vehicles, %	2	2	2	2	2	2	2	2	2	2	2	2
Mvmt Flow	1	0	10	45	0	3	15	10	39	1	7	2

Major/Minor	Minor2		Minor1			Major1			Major2			
Conflicting Flow All	50	89	8	68	71	29	9	0	0	49	0	0
Stage 1	10	10	-	60	60	-	-	-	-	-	-	-
Stage 2	40	79	-	9	11	-	-	-	-	-	-	-
Critical Hdwy	7.12	6.52	6.22	7.12	6.52	6.22	4.12	-	-	4.12	-	-
Critical Hdwy Stg 1	6.12	5.52	-	6.12	5.52	-	-	-	-	-	-	-
Critical Hdwy Stg 2	6.12	5.52	-	6.12	5.52	-	-	-	-	-	-	-
Follow-up Hdwy	3.518	4.018	3.318	3.518	4.018	3.318	2.218	-	-	2.218	-	-
Pot Cap-1 Maneuver	950	801	1075	924	820	1045	1611	-	-	1558	-	-
Stage 1	1011	887	-	952	845	-	-	-	-	-	-	-
Stage 2	975	829	-	1013	887	-	-	-	-	-	-	-
Platoon blocked, %								-	-	-	-	-
Mov Cap-1 Maneuver	937	793	1075	906	812	1045	1611	-	-	1558	-	-
Mov Cap-2 Maneuver	937	793	-	906	812	-	-	-	-	-	-	-
Stage 1	1011	887	-	943	837	-	-	-	-	-	-	-
Stage 2	962	821	-	1003	886	-	-	-	-	-	-	-

Approach	EB		WB			NB			SB		
HCM Ctrl Dly, s/v	8.43		9.15			1.72			0.81		
HCM LOS	A		A								

Minor Lane/Major Mvmt	NBL	NBT	NBR	EBLn1WBLn1	SBL	SBT	SBR
Capacity (veh/h)	1611	-	-	1059	915	1558	-
HCM Lane V/C Ratio	0.009	-	-	0.01	0.052	0.001	-
HCM Ctrl Dly (s/v)	7.3	-	-	8.4	9.2	7.3	-
HCM Lane LOS	A	-	-	A	A	A	-
HCM 95th %tile Q(veh)	0	-	-	0	0.2	0	-

Intersection												
Int Delay, s/veh	4.7											
Movement	EBL	EBT	EBR	WBL	WBT	WBR	NBL	NBT	NBR	SBL	SBT	SBR
Lane Configurations		+			+		↑	↑		↑	↑	
Traffic Vol, veh/h	2	0	14	65	0	4	4	23	12	0	48	1
Future Vol, veh/h	2	0	14	65	0	4	4	23	12	0	48	1
Conflicting Peds, #/hr	0	0	0	0	0	0	0	0	0	0	0	0
Sign Control	Stop	Stop	Stop	Stop	Stop	Stop	Free	Free	Free	Free	Free	Free
RT Channelized	-	-	None	-	-	None	-	-	None	-	-	None
Storage Length	-	-	-	-	-	-	0	-	-	0	-	-
Veh in Median Storage, #	-	0	-	-	0	-	-	0	-	-	0	-
Grade, %	-	0	-	-	0	-	-	0	-	-	0	-
Peak Hour Factor	92	92	92	92	92	92	92	92	92	92	92	92
Heavy Vehicles, %	2	2	2	2	2	2	2	2	2	2	2	2
Mvmt Flow	2	0	15	71	0	4	4	25	13	0	52	1

Major/Minor	Minor2		Minor1		Major1		Major2					
Conflicting Flow All	86	99	53	92	93	32	53	0	0	38	0	0
Stage 1	53	53	-	40	40	-	-	-	-	-	-	-
Stage 2	34	47	-	52	53	-	-	-	-	-	-	-
Critical Hdwy	7.12	6.52	6.22	7.12	6.52	6.22	4.12	-	-	4.12	-	-
Critical Hdwy Stg 1	6.12	5.52	-	6.12	5.52	-	-	-	-	-	-	-
Critical Hdwy Stg 2	6.12	5.52	-	6.12	5.52	-	-	-	-	-	-	-
Follow-up Hdwy	3.518	4.018	3.318	3.518	4.018	3.318	2.218	-	-	2.218	-	-
Pot Cap-1 Maneuver	899	791	1015	891	797	1042	1552	-	-	1572	-	-
Stage 1	960	851	-	975	861	-	-	-	-	-	-	-
Stage 2	982	856	-	961	850	-	-	-	-	-	-	-
Platoon blocked, %								-	-	-	-	-
Mov Cap-1 Maneuver	893	788	1015	876	794	1042	1552	-	-	1572	-	-
Mov Cap-2 Maneuver	893	788	-	876	794	-	-	-	-	-	-	-
Stage 1	960	851	-	972	859	-	-	-	-	-	-	-
Stage 2	975	854	-	946	850	-	-	-	-	-	-	-

Approach	EB		WB		NB		SB	
HCM Ctrl Dly, s/v	8.67		9.45		0.75		0	
HCM LOS	A		A					

Minor Lane/Major Mvmt	NBL	NBT	NBR	EBLn1WBLn1	SBL	SBT	SBR
Capacity (veh/h)	1552	-	-	998	884	1572	-
HCM Lane V/C Ratio	0.003	-	-	0.017	0.085	-	-
HCM Ctrl Dly (s/v)	7.3	-	-	8.7	9.5	0	-
HCM Lane LOS	A	-	-	A	A	A	-
HCM 95th %tile Q(veh)	0	-	-	0.1	0.3	0	-

Intersection												
Int Delay, s/veh	4.8											
Movement	EBL	EBT	EBR	WBL	WBT	WBR	NBL	NBT	NBR	SBL	SBT	SBR
Lane Configurations		+			+		+	+		+	+	
Traffic Vol, veh/h	1	0	9	41	0	3	14	9	36	1	7	2
Future Vol, veh/h	1	0	9	41	0	3	14	9	36	1	7	2
Conflicting Peds, #/hr	0	0	0	0	0	0	0	0	0	0	0	0
Sign Control	Stop	Stop	Stop	Stop	Stop	Stop	Free	Free	Free	Free	Free	Free
RT Channelized	-	-	None	-	-	None	-	-	None	-	-	None
Storage Length	-	-	-	-	-	-	0	-	-	0	-	-
Veh in Median Storage, #	-	0	-	-	0	-	-	0	-	-	0	-
Grade, %	-	0	-	-	0	-	-	0	-	-	0	-
Peak Hour Factor	92	92	92	92	92	92	92	92	92	92	92	92
Heavy Vehicles, %	2	2	2	2	2	2	2	2	2	2	2	2
Mvmt Flow	1	0	10	45	0	3	15	10	39	1	8	2

Major/Minor	Minor2		Minor1		Major1		Major2					
Conflicting Flow All	51	90	9	70	72	29	10	0	0	49	0	0
Stage 1	11	11	-	60	60	-	-	-	-	-	-	-
Stage 2	40	79	-	10	12	-	-	-	-	-	-	-
Critical Hdwy	7.12	6.52	6.22	7.12	6.52	6.22	4.12	-	-	4.12	-	-
Critical Hdwy Stg 1	6.12	5.52	-	6.12	5.52	-	-	-	-	-	-	-
Critical Hdwy Stg 2	6.12	5.52	-	6.12	5.52	-	-	-	-	-	-	-
Follow-up Hdwy	3.518	4.018	3.318	3.518	4.018	3.318	2.218	-	-	2.218	-	-
Pot Cap-1 Maneuver	948	800	1073	922	819	1045	1610	-	-	1558	-	-
Stage 1	1010	887	-	952	845	-	-	-	-	-	-	-
Stage 2	975	829	-	1011	886	-	-	-	-	-	-	-
Platoon blocked, %								-	-	-	-	-
Mov Cap-1 Maneuver	936	792	1073	905	810	1045	1610	-	-	1558	-	-
Mov Cap-2 Maneuver	936	792	-	905	810	-	-	-	-	-	-	-
Stage 1	1009	886	-	943	837	-	-	-	-	-	-	-
Stage 2	962	821	-	1001	885	-	-	-	-	-	-	-

Approach	EB		WB		NB		SB	
HCM Ctrl Dly, s/v	8.44		9.16		1.72		0.73	
HCM LOS	A		A					

Minor Lane/Major Mvmt	NBL	NBT	NBR	EBLn1WBLn1	SBL	SBT	SBR
Capacity (veh/h)	1610	-	-	1058	913	1558	-
HCM Lane V/C Ratio	0.009	-	-	0.01	0.052	0.001	-
HCM Ctrl Dly (s/v)	7.3	-	-	8.4	9.2	7.3	-
HCM Lane LOS	A	-	-	A	A	A	-
HCM 95th %tile Q(veh)	0	-	-	0	0.2	0	-

Intersection						
Int Delay, s/veh	0.6					
Movement	WBL	WBR	NBT	NBR	SBL	SBT
Lane Configurations		↗	↘			↑
Traffic Vol, veh/h	0	11	26	14	0	119
Future Vol, veh/h	0	11	26	14	0	119
Conflicting Peds, #/hr	0	0	0	0	0	0
Sign Control	Stop	Stop	Free	Free	Free	Free
RT Channelized	-	None	-	None	-	None
Storage Length	-	0	-	-	-	-
Veh in Median Storage, #	0	-	0	-	-	0
Grade, %	0	-	0	-	-	0
Peak Hour Factor	92	92	92	92	92	92
Heavy Vehicles, %	2	2	2	2	2	2
Mvmt Flow	0	12	28	15	0	129

Major/Minor	Minor1	Major1	Major2		
Conflicting Flow All	-	36	0	0	-
Stage 1	-	-	-	-	-
Stage 2	-	-	-	-	-
Critical Hdwy	-	6.22	-	-	-
Critical Hdwy Stg 1	-	-	-	-	-
Critical Hdwy Stg 2	-	-	-	-	-
Follow-up Hdwy	-	3.318	-	-	-
Pot Cap-1 Maneuver	0	1037	-	-	0
Stage 1	0	-	-	-	0
Stage 2	0	-	-	-	0
Platoon blocked, %			-	-	-
Mov Cap-1 Maneuver	-	1037	-	-	-
Mov Cap-2 Maneuver	-	-	-	-	-
Stage 1	-	-	-	-	-
Stage 2	-	-	-	-	-

Approach	WB	NB	SB
HCM Ctrl Dly, s/v	8.51	0	0
HCM LOS	A		

Minor Lane/Major Mvmt	NBT	NBRWBLn1	SBT
Capacity (veh/h)	-	-	1037
HCM Lane V/C Ratio	-	-	0.012
HCM Ctrl Dly (s/v)	-	-	8.5
HCM Lane LOS	-	-	A
HCM 95th %tile Q(veh)	-	-	0

Intersection						
Int Delay, s/veh	0.4					
Movement	WBL	WBR	NBT	NBR	SBL	SBT
Lane Configurations		↗	↘			↖
Traffic Vol, veh/h	0	7	52	43	0	54
Future Vol, veh/h	0	7	52	43	0	54
Conflicting Peds, #/hr	0	0	0	0	0	0
Sign Control	Stop	Stop	Free	Free	Free	Free
RT Channelized	-	None	-	None	-	None
Storage Length	-	0	-	-	-	-
Veh in Median Storage, #	0	-	0	-	-	0
Grade, %	0	-	0	-	-	0
Peak Hour Factor	92	92	92	92	92	92
Heavy Vehicles, %	2	2	2	2	2	2
Mvmt Flow	0	8	57	47	0	59

Major/Minor	Minor1	Major1	Major2			
Conflicting Flow All	-	80	0	0	-	-
Stage 1	-	-	-	-	-	-
Stage 2	-	-	-	-	-	-
Critical Hdwy	-	6.22	-	-	-	-
Critical Hdwy Stg 1	-	-	-	-	-	-
Critical Hdwy Stg 2	-	-	-	-	-	-
Follow-up Hdwy	-	3.318	-	-	-	-
Pot Cap-1 Maneuver	0	980	-	-	0	-
Stage 1	0	-	-	-	0	-
Stage 2	0	-	-	-	0	-
Platoon blocked, %			-	-		-
Mov Cap-1 Maneuver	-	980	-	-	-	-
Mov Cap-2 Maneuver	-	-	-	-	-	-
Stage 1	-	-	-	-	-	-
Stage 2	-	-	-	-	-	-

Approach	WB	NB	SB
HCM Ctrl Dly, s/v	8.7	0	0
HCM LOS	A		

Minor Lane/Major Mvmt	NBT	NBRWBLn1	SBT
Capacity (veh/h)	-	-	980
HCM Lane V/C Ratio	-	-	0.008
HCM Ctrl Dly (s/v)	-	-	8.7
HCM Lane LOS	-	-	A
HCM 95th %tile Q(veh)	-	-	0

Intersection						
Int Delay, s/veh	0.5					
Movement	WBL	WBR	NBT	NBR	SBL	SBT
Lane Configurations		↗	↘			↑
Traffic Vol, veh/h	0	11	28	14	0	127
Future Vol, veh/h	0	11	28	14	0	127
Conflicting Peds, #/hr	0	0	0	0	0	0
Sign Control	Stop	Stop	Free	Free	Free	Free
RT Channelized	-	None	-	None	-	None
Storage Length	-	0	-	-	-	-
Veh in Median Storage, #	0	-	0	-	-	0
Grade, %	0	-	0	-	-	0
Peak Hour Factor	92	92	92	92	92	92
Heavy Vehicles, %	2	2	2	2	2	2
Mvmt Flow	0	12	30	15	0	138

Major/Minor	Minor1	Major1	Major2			
Conflicting Flow All	-	38	0	0	-	-
Stage 1	-	-	-	-	-	-
Stage 2	-	-	-	-	-	-
Critical Hdwy	-	6.22	-	-	-	-
Critical Hdwy Stg 1	-	-	-	-	-	-
Critical Hdwy Stg 2	-	-	-	-	-	-
Follow-up Hdwy	-	3.318	-	-	-	-
Pot Cap-1 Maneuver	0	1034	-	-	0	-
Stage 1	0	-	-	-	0	-
Stage 2	0	-	-	-	0	-
Platoon blocked, %			-	-		-
Mov Cap-1 Maneuver	-	1034	-	-	-	-
Mov Cap-2 Maneuver	-	-	-	-	-	-
Stage 1	-	-	-	-	-	-
Stage 2	-	-	-	-	-	-

Approach	WB	NB	SB
HCM Ctrl Dly, s/v	8.52	0	0
HCM LOS	A		

Minor Lane/Major Mvmt	NBT	NBRWBLn1	SBT
Capacity (veh/h)	-	- 1034	-
HCM Lane V/C Ratio	-	- 0.012	-
HCM Ctrl Dly (s/v)	-	- 8.5	-
HCM Lane LOS	-	- A	-
HCM 95th %tile Q(veh)	-	- 0	-

Intersection						
Int Delay, s/veh	0.4					
Movement	WBL	WBR	NBT	NBR	SBL	SBT
Lane Configurations		↗	↘			↕
Traffic Vol, veh/h	0	7	52	43	0	55
Future Vol, veh/h	0	7	52	43	0	55
Conflicting Peds, #/hr	0	0	0	0	0	0
Sign Control	Stop	Stop	Free	Free	Free	Free
RT Channelized	-	None	-	None	-	None
Storage Length	-	0	-	-	-	-
Veh in Median Storage, #	0	-	0	-	-	0
Grade, %	0	-	0	-	-	0
Peak Hour Factor	92	92	92	92	92	92
Heavy Vehicles, %	2	2	2	2	2	2
Mvmt Flow	0	8	57	47	0	60

Major/Minor	Minor1	Major1	Major2			
Conflicting Flow All	-	80	0	0	-	-
Stage 1	-	-	-	-	-	-
Stage 2	-	-	-	-	-	-
Critical Hdwy	-	6.22	-	-	-	-
Critical Hdwy Stg 1	-	-	-	-	-	-
Critical Hdwy Stg 2	-	-	-	-	-	-
Follow-up Hdwy	-	3.318	-	-	-	-
Pot Cap-1 Maneuver	0	980	-	-	0	-
Stage 1	0	-	-	-	0	-
Stage 2	0	-	-	-	0	-
Platoon blocked, %			-	-	-	-
Mov Cap-1 Maneuver	-	980	-	-	-	-
Mov Cap-2 Maneuver	-	-	-	-	-	-
Stage 1	-	-	-	-	-	-
Stage 2	-	-	-	-	-	-

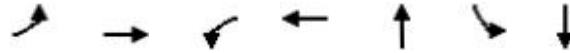
Approach	WB	NB	SB
HCM Ctrl Dly, s/v	8.7	0	0
HCM LOS	A		

Minor Lane/Major Mvmt	NBT	NBRWBLn1	SBT
Capacity (veh/h)	-	-	980
HCM Lane V/C Ratio	-	-	0.008
HCM Ctrl Dly (s/v)	-	-	8.7
HCM Lane LOS	-	-	A
HCM 95th %tile Q(veh)	-	-	0

# Appendix F: Queue Analysis Worksheets

Queues  
4: Greensborough Dr/Plaza Cir & Plaza Dr

2028 Total2 AM\_Signalized  
02/05/2026

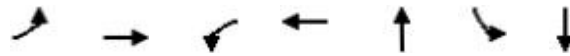


Lane Group	EBL	EBT	WBL	WBT	NBT	SBL	SBT
Lane Group Flow (vph)	27	1027	37	1102	117	166	19
v/c Ratio	0.08	0.43	0.10	0.47	0.33	0.81	0.05
Control Delay (s/veh)	6.6	12.2	9.2	16.1	14.2	74.5	0.2
Queue Delay	0.0	0.0	0.0	0.0	0.0	0.0	0.0
Total Delay (s/veh)	6.6	12.2	9.2	16.1	14.2	74.5	0.2
Queue Length 50th (ft)	5	207	8	248	16	125	0
Queue Length 95th (ft)	11	177	19	244	20	114	0
Internal Link Dist (ft)		726		1812	1011		239
Turn Bay Length (ft)	200		150			250	
Base Capacity (vph)	346	2362	378	2358	530	344	575
Starvation Cap Reductn	0	0	0	0	0	0	0
Spillback Cap Reductn	0	0	0	0	0	0	0
Storage Cap Reductn	0	0	0	0	0	0	0
Reduced v/c Ratio	0.08	0.43	0.10	0.47	0.22	0.48	0.03

Intersection Summary

Queues

4: Greensborough Dr/Plaza Cir & Plaza Dr

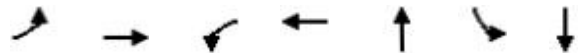


Lane Group	EBL	EBT	WBL	WBT	NBT	SBL	SBT
Lane Group Flow (vph)	33	361	47	377	48	53	9
v/c Ratio	0.04	0.13	0.06	0.14	0.23	0.37	0.01
Control Delay (s/veh)	2.8	5.4	2.8	4.5	5.5	58.7	0.0
Queue Delay	0.0	0.0	0.0	0.0	0.0	0.0	0.0
Total Delay (s/veh)	2.8	5.4	2.8	4.5	5.5	58.7	0.0
Queue Length 50th (ft)	4	40	5	38	0	39	0
Queue Length 95th (ft)	11	63	14	60	9	75	0
Internal Link Dist (ft)		726		1812	1011		244
Turn Bay Length (ft)	200		150			250	
Base Capacity (vph)	925	2748	951	2753	538	511	896
Starvation Cap Reductn	0	0	0	0	0	0	0
Spillback Cap Reductn	0	0	0	0	0	0	0
Storage Cap Reductn	0	0	0	0	0	0	0
Reduced v/c Ratio	0.04	0.13	0.05	0.14	0.09	0.10	0.01

Intersection Summary

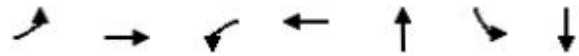
## 4: Greensborough Dr/Plaza Cir &amp; Plaza Dr

02/05/2026



Lane Group	EBL	EBT	WBL	WBT	NBT	SBL	SBT
Lane Group Flow (vph)	31	1201	44	1295	139	176	19
v/c Ratio	0.11	0.54	0.15	0.56	0.36	0.84	0.05
Control Delay (s/veh)	7.8	15.6	7.8	15.1	13.4	77.5	0.2
Queue Delay	0.0	0.0	0.0	0.0	0.0	0.0	0.0
Total Delay (s/veh)	7.8	15.6	7.8	15.1	13.4	77.5	0.2
Queue Length 50th (ft)	6	273	9	305	19	133	0
Queue Length 95th (ft)	13	225	17	243	21	119	0
Internal Link Dist (ft)		726		1812	1011		239
Turn Bay Length (ft)	200		150			250	
Base Capacity (vph)	273	2234	300	2305	540	323	556
Starvation Cap Reductn	0	0	0	0	0	0	0
Spillback Cap Reductn	0	0	0	0	0	0	0
Storage Cap Reductn	0	0	0	0	0	0	0
Reduced v/c Ratio	0.11	0.54	0.15	0.56	0.26	0.54	0.03

## Intersection Summary



Lane Group	EBL	EBT	WBL	WBT	NBT	SBL	SBT
Lane Group Flow (vph)	33	423	56	423	57	53	9
v/c Ratio	0.04	0.15	0.07	0.15	0.27	0.40	0.01
Control Delay (s/veh)	2.8	5.5	2.8	4.7	7.9	60.5	0.0
Queue Delay	0.0	0.0	0.0	0.0	0.0	0.0	0.0
Total Delay (s/veh)	2.8	5.5	2.8	4.7	7.9	60.5	0.0
Queue Length 50th (ft)	4	48	6	45	0	40	0
Queue Length 95th (ft)	11	74	16	69	18	75	0
Internal Link Dist (ft)		726		1812	1011		244
Turn Bay Length (ft)	200		150			250	
Base Capacity (vph)	893	2740	910	2759	538	470	864
Starvation Cap Reductn	0	0	0	0	0	0	0
Spillback Cap Reductn	0	0	0	0	0	0	0
Storage Cap Reductn	0	0	0	0	0	0	0
Reduced v/c Ratio	0.04	0.15	0.06	0.15	0.11	0.11	0.01

## Intersection Summary

Queues  
5: Kendrick Castillo Way & Plaza Dr

2028 Total AM  
02/05/2026



Lane Group	EBL	EBT	WBL	WBT	WBR	NBL	NBT	SBL	SBT
Lane Group Flow (vph)	380	458	27	152	197	288	1520	520	1481
v/c Ratio	1.04	0.59	0.19	0.48	0.31	0.66	0.75	0.78	0.64
Control Delay (s/veh)	110.9	31.6	58.8	56.3	8.3	57.6	34.5	47.9	35.0
Queue Delay	0.0	0.0	0.0	0.0	0.0	0.0	0.0	0.0	0.0
Total Delay (s/veh)	110.9	31.6	58.8	56.3	8.3	57.6	34.5	47.9	35.0
Queue Length 50th (ft)	~164	114	10	61	22	111	375	208	378
Queue Length 95th (ft)	#259	162	26	92	72	152	438	#283	447
Internal Link Dist (ft)		1812		1854			1575		1061
Turn Bay Length (ft)	300		225		300	275		250	
Base Capacity (vph)	364	870	143	530	644	471	2014	666	2319
Starvation Cap Reductn	0	0	0	0	0	0	0	0	0
Spillback Cap Reductn	0	0	0	0	0	0	0	0	0
Storage Cap Reductn	0	0	0	0	0	0	0	0	0
Reduced v/c Ratio	1.04	0.53	0.19	0.29	0.31	0.61	0.75	0.78	0.64

Intersection Summary

~ Volume exceeds capacity, queue is theoretically infinite.  
Queue shown is maximum after two cycles.

# 95th percentile volume exceeds capacity, queue may be longer.  
Queue shown is maximum after two cycles.

Queues  
5: Kendrick Castillo Way & Plaza Dr

2028 Total PM  
02/05/2026



Lane Group	EBL	EBT	WBL	WBT	WBR	NBL	NBT	SBL	SBT
Lane Group Flow (vph)	331	348	141	111	408	134	1584	230	1895
v/c Ratio	0.77	0.67	0.56	0.45	0.77	0.50	0.65	0.44	0.68
Control Delay (s/veh)	72.2	39.9	71.3	67.9	41.1	68.3	30.9	55.9	24.9
Queue Delay	0.0	0.0	0.0	0.0	0.0	0.0	0.0	0.0	0.0
Total Delay (s/veh)	72.2	39.9	71.3	67.9	41.1	68.3	30.9	55.9	24.9
Queue Length 50th (ft)	151	92	64	52	238	61	404	98	445
Queue Length 95th (ft)	205	144	101	83	335	95	515	134	545
Internal Link Dist (ft)		1812		1854			1575		1061
Turn Bay Length (ft)	300		225		300	275		250	
Base Capacity (vph)	462	721	275	464	562	276	2449	599	2791
Starvation Cap Reductn	0	0	0	0	0	0	0	0	0
Spillback Cap Reductn	0	0	0	0	0	0	0	0	0
Storage Cap Reductn	0	0	0	0	0	0	0	0	0
Reduced v/c Ratio	0.72	0.48	0.51	0.24	0.73	0.49	0.65	0.38	0.68

Intersection Summary

Queues  
5: Kendrick Castillo Way & Plaza Dr

2045 Total AM  
02/05/2026



Lane Group	EBL	EBT	WBL	WBT	WBR	NBL	NBT	SBL	SBT
Lane Group Flow (vph)	437	530	31	179	233	338	1800	616	1749
v/c Ratio	0.78	0.59	0.19	0.58	0.37	0.77	0.99	0.86	0.79
Control Delay (s/veh)	66.7	37.8	66.2	68.8	16.0	71.7	62.7	65.8	36.9
Queue Delay	0.0	0.0	0.0	0.0	0.0	0.0	0.0	0.0	0.0
Total Delay (s/veh)	66.7	37.8	66.2	68.8	16.0	71.7	62.7	65.8	36.9
Queue Length 50th (ft)	199	175	14	85	63	155	-650	279	500
Queue Length 95th (ft)	247	225	32	123	138	#212	#733	#421	593
Internal Link Dist (ft)		1812		1854			1575		1061
Turn Bay Length (ft)	300		225		300	275		250	
Base Capacity (vph)	662	898	318	379	635	455	1822	720	2203
Starvation Cap Reductn	0	0	0	0	0	0	0	0	0
Spillback Cap Reductn	0	0	0	0	0	0	0	0	0
Storage Cap Reductn	0	0	0	0	0	0	0	0	0
Reduced v/c Ratio	0.66	0.59	0.10	0.47	0.37	0.74	0.99	0.86	0.79

Intersection Summary

~ Volume exceeds capacity, queue is theoretically infinite.  
Queue shown is maximum after two cycles.

# 95th percentile volume exceeds capacity, queue may be longer.  
Queue shown is maximum after two cycles.

Queues  
5: Kendrick Castillo Way & Plaza Dr

2045 Total PM  
02/05/2026



Lane Group	EBL	EBT	WBL	WBT	WBR	NBL	NBT	SBL	SBT
Lane Group Flow (vph)	384	405	166	129	482	152	1876	273	2233
v/c Ratio	0.85	0.73	0.64	0.45	0.83	0.57	0.84	0.45	0.82
Control Delay (s/veh)	78.0	45.8	74.3	66.1	45.2	70.6	40.5	53.9	31.2
Queue Delay	0.0	0.0	0.0	0.0	0.0	0.0	0.0	0.0	0.0
Total Delay (s/veh)	78.0	45.8	74.3	66.1	45.2	70.6	40.5	53.9	31.2
Queue Length 50th (ft)	178	125	76	60	296	69	583	111	602
Queue Length 95th (ft)	#254	177	116	92	440	108	657	162	732
Internal Link Dist (ft)		1812		1854			1575		1061
Turn Bay Length (ft)	300		225		300	275		250	
Base Capacity (vph)	462	714	275	464	591	275	2233	635	2711
Starvation Cap Reductn	0	0	0	0	0	0	0	0	0
Spillback Cap Reductn	0	0	0	0	0	0	0	0	0
Storage Cap Reductn	0	0	0	0	0	0	0	0	0
Reduced v/c Ratio	0.83	0.57	0.60	0.28	0.82	0.55	0.84	0.43	0.82

Intersection Summary

# 95th percentile volume exceeds capacity, queue may be longer.  
Queue shown is maximum after two cycles.



Lane Group	EBL	EBT	EBR	NBT	NBR	SBL	SBT
Lane Group Flow (vph)	84	85	1123	1370	690	47	870
v/c Ratio	0.18	0.19	0.70	0.46	0.57	0.19	0.37
Control Delay (s/veh)	30.6	29.5	2.6	16.1	11.7	23.7	25.7
Queue Delay	0.0	0.0	0.0	0.0	0.0	0.0	0.0
Total Delay (s/veh)	30.6	29.5	2.6	16.1	11.7	23.7	25.7
Queue Length 50th (ft)	48	48	0	322	288	29	286
Queue Length 95th (ft)	89	90	0	m347	m483	m47	336
Internal Link Dist (ft)		1200		1061			645
Turn Bay Length (ft)			100			550	
Base Capacity (vph)	566	453	1599	2955	1202	484	2347
Starvation Cap Reductn	0	0	0	0	0	0	0
Spillback Cap Reductn	0	0	0	0	0	0	0
Storage Cap Reductn	0	0	0	0	0	0	0
Reduced v/c Ratio	0.15	0.19	0.70	0.46	0.57	0.10	0.37

Intersection Summary

m Volume for 95th percentile queue is metered by upstream signal.



Lane Group	EBL	EBT	EBR	NBT	NBR	SBL	SBT
Lane Group Flow (vph)	41	41	1009	1332	779	123	1050
v/c Ratio	0.09	0.09	0.62	0.49	0.64	0.43	0.44
Control Delay (s/veh)	28.0	28.1	1.8	22.3	4.5	26.1	18.5
Queue Delay	0.0	0.0	0.0	0.0	0.0	0.0	0.0
Total Delay (s/veh)	28.0	28.1	1.8	22.3	4.5	26.1	18.5
Queue Length 50th (ft)	23	23	0	271	3	56	250
Queue Length 95th (ft)	50	50	0	338	86	m111	287
Internal Link Dist (ft)		1200		1061			645
Turn Bay Length (ft)			100			550	
Base Capacity (vph)	571	457	1615	2733	1215	495	2394
Starvation Cap Reductn	0	0	0	0	0	0	0
Spillback Cap Reductn	0	0	0	0	0	0	0
Storage Cap Reductn	0	0	0	0	0	0	0
Reduced v/c Ratio	0.07	0.09	0.62	0.49	0.64	0.25	0.44

Intersection Summary

m Volume for 95th percentile queue is metered by upstream signal.



Lane Group	EBL	EBT	EBR	NBT	NBR	SBL	SBT
Lane Group Flow (vph)	100	100	1329	1619	814	56	1029
v/c Ratio	0.18	0.18	0.83	0.64	0.73	0.32	0.50
Control Delay (s/veh)	30.6	30.6	5.2	25.1	8.9	25.6	31.2
Queue Delay	0.0	0.0	0.0	0.0	0.0	0.0	0.0
Total Delay (s/veh)	30.6	30.6	5.2	25.1	8.9	25.6	31.2
Queue Length 50th (ft)	58	58	0	349	68	35	340
Queue Length 95th (ft)	106	106	0	415	245	m50	392
Internal Link Dist (ft)		1200		1061			645
Turn Bay Length (ft)			100			550	
Base Capacity (vph)	544	544	1599	2511	1120	426	2049
Starvation Cap Reductn	0	0	0	0	0	0	0
Spillback Cap Reductn	0	0	0	0	0	0	0
Storage Cap Reductn	0	0	0	0	0	0	0
Reduced v/c Ratio	0.18	0.18	0.83	0.64	0.73	0.13	0.50

Intersection Summary

m Volume for 95th percentile queue is metered by upstream signal.



Lane Group	EBL	EBT	EBR	NBT	NBR	SBL	SBT
Lane Group Flow (vph)	48	49	1189	1574	921	146	1237
v/c Ratio	0.11	0.11	0.74	0.59	0.76	0.59	0.52
Control Delay (s/veh)	29.3	29.4	3.0	25.0	9.9	37.6	19.5
Queue Delay	0.0	0.0	0.0	0.0	0.0	0.0	0.0
Total Delay (s/veh)	29.3	29.4	3.0	25.0	9.9	37.6	19.5
Queue Length 50th (ft)	27	27	0	347	72	91	294
Queue Length 95th (ft)	57	58	0	435	319	m129	360
Internal Link Dist (ft)		1200		1061			645
Turn Bay Length (ft)			100			550	
Base Capacity (vph)	550	440	1615	2690	1208	456	2394
Starvation Cap Reductn	0	0	0	0	0	0	95
Spillback Cap Reductn	0	0	0	0	0	0	0
Storage Cap Reductn	0	0	0	0	0	0	0
Reduced v/c Ratio	0.09	0.11	0.74	0.59	0.76	0.32	0.54

**Intersection Summary**

m Volume for 95th percentile queue is metered by upstream signal.

Queues

2028 Total AM

7: Kendrick Castillo Way & C-470 WB On-Ramp/C-470 WB Off-Ramp

02/05/2026



Lane Group	WBL	WBT	WBR	NBL	NBT	SBT	SBR
Lane Group Flow (vph)	329	331	163	812	694	238	36
v/c Ratio	0.71	0.71	0.10	0.82	0.30	0.21	0.02
Control Delay (s/veh)	49.0	49.2	0.1	70.6	3.2	30.9	0.0
Queue Delay	0.0	0.0	0.0	0.0	0.0	0.0	0.0
Total Delay (s/veh)	49.0	49.2	0.1	70.6	3.2	30.9	0.0
Queue Length 50th (ft)	246	247	0	351	36	71	0
Queue Length 95th (ft)	362	365	0	416	64	113	0
Internal Link Dist (ft)		1177			645	1677	
Turn Bay Length (ft)			250				500
Base Capacity (vph)	462	463	1583	1271	2323	1159	1583
Starvation Cap Reductn	0	0	0	0	0	0	0
Spillback Cap Reductn	0	0	0	0	0	0	0
Storage Cap Reductn	0	0	0	0	0	0	0
Reduced v/c Ratio	0.71	0.71	0.10	0.64	0.30	0.21	0.02

Intersection Summary

Queues

2028 Total PM

7: Kendrick Castillo Way & C-470 WB On-Ramp/C-470 WB Off-Ramp

02/05/2026



Lane Group	WBL	WBT	WBR	NBL	NBT	SBT	SBR
Lane Group Flow (vph)	329	331	91	904	487	591	135
v/c Ratio	0.70	0.70	0.06	0.84	0.21	0.54	0.08
Control Delay (s/veh)	48.2	48.2	0.1	72.0	6.6	38.1	0.1
Queue Delay	0.0	0.0	0.0	0.0	0.0	0.0	0.0
Total Delay (s/veh)	48.2	48.2	0.1	72.0	6.6	38.1	0.1
Queue Length 50th (ft)	241	243	0	388	44	201	0
Queue Length 95th (ft)	353	356	0	455	60	282	0
Internal Link Dist (ft)		1177			645	1677	
Turn Bay Length (ft)			250				500
Base Capacity (vph)	471	473	1615	1284	2346	1095	1615
Starvation Cap Reductn	0	0	0	0	0	0	0
Spillback Cap Reductn	0	0	0	0	0	0	0
Storage Cap Reductn	0	0	0	0	0	0	0
Reduced v/c Ratio	0.70	0.70	0.06	0.70	0.21	0.54	0.08

Intersection Summary



Lane Group	WBL	WBT	WBR	NBL	NBT	SBT	SBR
Lane Group Flow (vph)	389	391	193	958	821	280	42
v/c Ratio	0.84	0.84	0.12	0.86	0.35	0.27	0.03
Control Delay (s/veh)	58.7	58.9	0.2	74.6	7.8	34.8	0.0
Queue Delay	0.0	0.0	0.0	0.0	0.0	0.0	0.0
Total Delay (s/veh)	58.7	58.9	0.2	74.6	7.8	34.8	0.0
Queue Length 50th (ft)	304	306	0	415	88	90	0
Queue Length 95th (ft)	#481	#483	0	481	131	136	0
Internal Link Dist (ft)		1177			645	1677	
Turn Bay Length (ft)			250				500
Base Capacity (vph)	462	463	1583	1271	2323	1027	1583
Starvation Cap Reductn	0	0	0	0	0	0	0
Spillback Cap Reductn	0	0	0	0	0	0	0
Storage Cap Reductn	0	0	0	0	0	0	0
Reduced v/c Ratio	0.84	0.84	0.12	0.75	0.35	0.27	0.03

Intersection Summary

# 95th percentile volume exceeds capacity, queue may be longer.  
 Queue shown is maximum after two cycles.



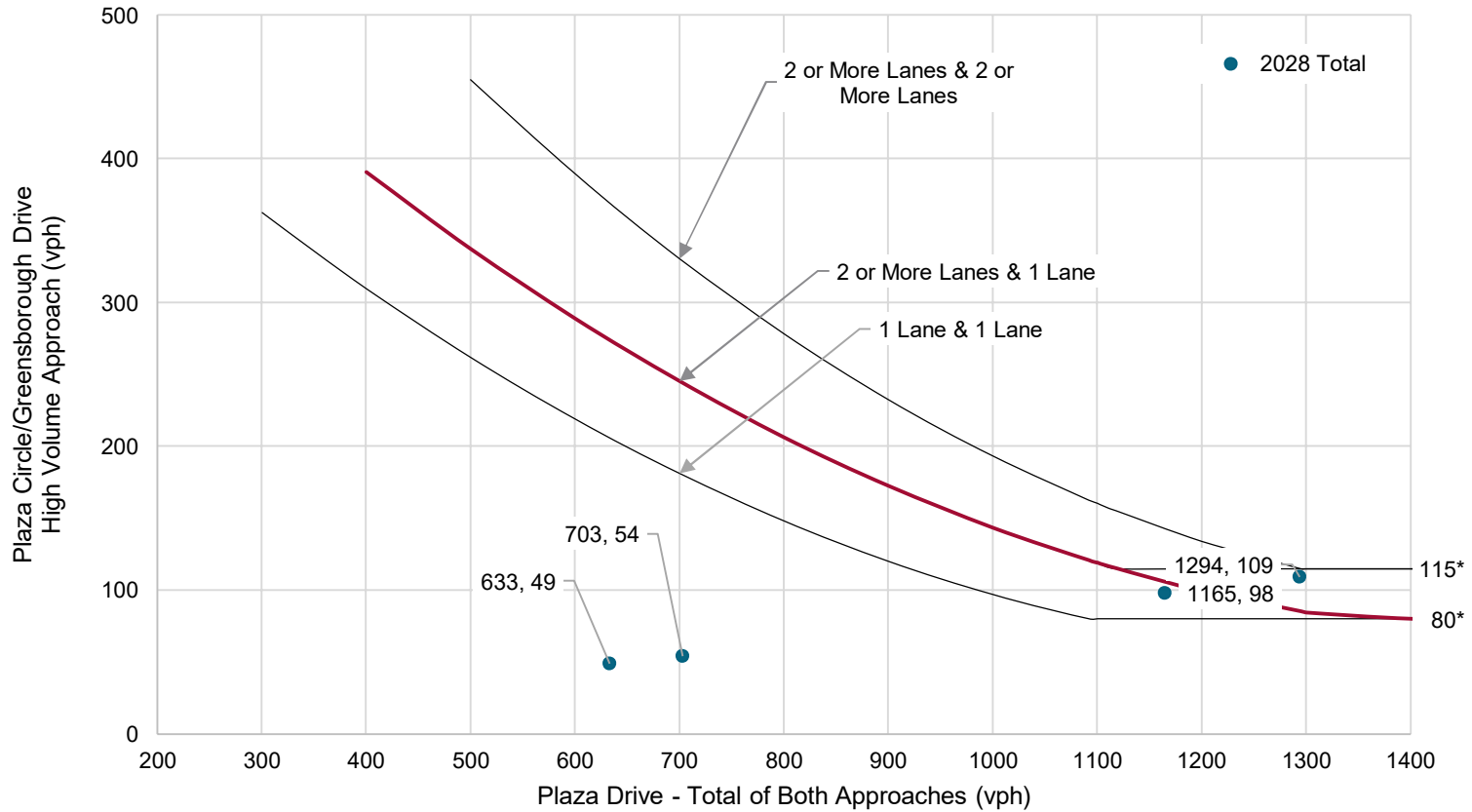
Lane Group	WBL	WBT	WBR	NBL	NBT	SBT	SBR
Lane Group Flow (vph)	387	389	109	1070	576	698	159
v/c Ratio	0.82	0.82	0.07	0.89	0.25	0.72	0.10
Control Delay (s/veh)	56.4	56.6	0.1	73.1	8.7	45.4	0.1
Queue Delay	0.0	0.0	0.0	0.0	0.0	0.0	0.0
Total Delay (s/veh)	56.4	56.6	0.1	73.1	8.7	45.4	0.1
Queue Length 50th (ft)	295	297	0	459	53	264	0
Queue Length 95th (ft)	#462	#464	0	528	120	339	0
Internal Link Dist (ft)		1177			645	1677	
Turn Bay Length (ft)			250				500
Base Capacity (vph)	471	472	1615	1284	2346	971	1615
Starvation Cap Reductn	0	0	0	0	0	0	0
Spillback Cap Reductn	0	0	0	0	0	0	0
Storage Cap Reductn	0	0	0	0	0	0	0
Reduced v/c Ratio	0.82	0.82	0.07	0.83	0.25	0.72	0.10

**Intersection Summary**

# 95th percentile volume exceeds capacity, queue may be longer.  
 Queue shown is maximum after two cycles.

# Appendix G: Signal Warrant Analysis Worksheet

### Warrant 2 - Four-Hour Vehicular Volume



\*Note: 115 vph applies as the lower threshold volume for a minor-street approach with two or more lanes and 80 vph applies as the lower threshold volume for a minor-street approach with one lane.

Plaza Drive & Plaza Circle/Greensborough Drive  
Signal Warrant Analysis  
Four-Hour Volume Warrant

Source: Manual on Uniform Traffic Control Devices 2023

Intersection #4





April 22, 2025

Douglas County Planning Services  
100 Third Street  
Castle Rock, CO 80104

Re: Water and Sewer for Project ZR2025-001, Highlands Ranch Planned Development, 80<sup>th</sup> Amendment

To Whom It May Concern:

Pursuant to Section 1805A.01 of the Douglas County Zoning Resolution, Highlands Ranch Water and Sanitation District (the "District") acknowledges its willingness and ability to serve all future proposed developments in its Highlands Ranch service area, including parcels in Filing 157, Lot 3 and 4.

**Verification of District Status:**

The District hereby verifies that the statements made in the letters and reports submitted by the District for the State Engineer and the County, and in the current materials are true and accurate, with the exception of any updates to the District's available water supply in accordance with the attached information.

**Commitment to Serve:**

The District is committed to providing service for all future developments within its service area based upon the water supply sources so identified. The connection to and use of such lines, mains and facilities is conditioned upon compliance with all the Rules and Regulations of the Districts, including the payment of the appropriate fees. Any applicant, owner or customer desiring water and/or sewer service from the District shall pay a Tap Fee prior to the installation of a water meter. Such fee shall be paid in addition to all other charges relating to water and/or sewer service as established from time to time by the Board of Directors.

**Water Demand:**

Based on the demands at buildout of Highlands Ranch, all existing and future developments within our service area will require 19,600 to 22,600 AF/year. At this time, with the existing development at approximately 95% of buildout, demand has not exceeded 17,000 AF/year.

The representative for the developer has stated that the development will include a mix of commercial uses and associated landscaping totaling 234 Single Family Equivalent (SFE) taps for domestic use. Based on Highlands Ranch's standard water demand requirements, this project will therefore require 117 acre-feet (AF) of water per year.



**Water Supply:**

The District's existing water supply (in accordance with the attached report on sources, storage and decrees) of over 30,000 AF/year is adequate to deliver water to all future development within its service area. Highlands Ranch's water supply includes an amount sufficient to meet the water demands for this property.

**Water Quality:**

The District is in compliance with the Colorado Department of Public Health and Environment testing and quality requirements and provides a high-quality water supply to all of its customers.

**Sanitary Sewer Service:**

The District shall provide sanitary sewer service for all water taps requested for this development. Treatment is provided by Highlands Ranch's Marcy Gulch Wastewater Treatment Plant.

**Feasibility of Service:**

Since its inception, Highlands Ranch has developed and funded an infrastructure plan to provide service to all properties within its service area. It is physically and economically feasible for the District to extend service to the proposed development.

**Documentation:**

Information describing Highlands Ranch's water supply including decrees is contained in the attached letter from Samuel L. Calkins, General Manager of Highlands Ranch Water and Sanitation District.

Sincerely,

A handwritten signature in blue ink that reads "Ryan Edwards".

Ryan Edwards  
Director of Engineering  
Highlands Ranch Water and Sanitation District

Enclosures



April 22, 2025

Douglas County Planning Services  
 100 Third Street  
 Castle Rock, CO 80104

**Re: Statement of Water Availability**

This letter serves as a general summary addressing the water supply for customers seeking water service within the Highlands Ranch Water and Sanitation District’s (HRWSD) service area through the Northern Douglas County Water and Sanitation District (NDCWSD), the Highlands Ranch Metropolitan District and Mirabelle Metropolitan District.

For planning purposes, the water demand projected for all existing and future customers in the HRWSD service area is estimated to be from 19,600 to 22,600 acre-feet per year (AF/yr.). The actual annual demand for the last few years has averaged about 17,000 AF/yr. and the HRWSD’s service area is approximately 95% developed. Approximately 90% of HRWSD’s reusable water is recycled for municipal purposes in the HRWSD water service area.

Water demands in the HRWSD service area are met through a robust conjunctive use system that includes both renewable surface water and reusable Denver Basin ground water. Captured surface-water supplies are stored in four reservoirs and in three of the four Denver Basin aquifers through an aquifer storage and recovery (ASR) program. HRWSD’s surface-water supplies are from several sources on the South Platte River and its tributaries, which are summarized in Table 1.

**Table 1**

Surface-Water Sources	Average Year Yield (AF/yr.)
Augmentation / Exchange Plan	3,000
Plum Creek	550
Cline Ranch	400
South Platte River / Reservoir	700
Hock Hocking Mine	100
Tingle Reservoir	100
Englewood Agreements	6,120
Denver Water (“Patti water”)	1,000
Bargas Ranch	900
Castle Pines North	50
WISE	1,000
Chatfield Reservoir	2,500
<b>Total Surface Water Supply (current)</b>	<b>16,420</b>



HRWSD's decreed annual yield of Denver Basin ground-water rights total 17,717 AF/yr., which are defined in Table 2. Ground water can be pumped from the Denver Basin aquifers through a well field array comprised of more than 50 wells.

**Table 2**

<b>Bedrock Aquifer</b>	<b>Decree Yield (af/yr.)</b>
Arapahoe	4,915
Denver	5,111
Laramie-Fox Hills	4,500
Laramie-Fox Hills West	340
Dawson	390
Not-Nontributary Denver	1,876
Phipps Arapahoe	585
<b>TOTAL</b>	<b>17,717</b>

In an average year, the total volume of water currently available for use by CWSD customers is more than 30,000 AF. In addition to these water rights, HRWSD has the use of 3,885 AF of storage space in McLellan Reservoir, 6,400 AF of storage space in South Platte Reservoir, 205 AF of storage space in James Tingle Reservoir, and 6,922 AF of storage space in the Chatfield Reservoir Reallocation Project. The total storage space is 17,412 AF.

HRWSD operates a successful ASR program that stores treated surface water in three of the four Denver Basin aquifers, and makes that water available for use at any time. The ASR program has been operated for over 20 years. To date, nearly 15,300 AF of treated potable water has been stored in the Denver Basin aquifers beneath Highlands Ranch and is available when needed to supplement the annual decreed quantities defined above.

The attached sheet lists the water right decrees for the various water sources available for service to HRWSD customers.

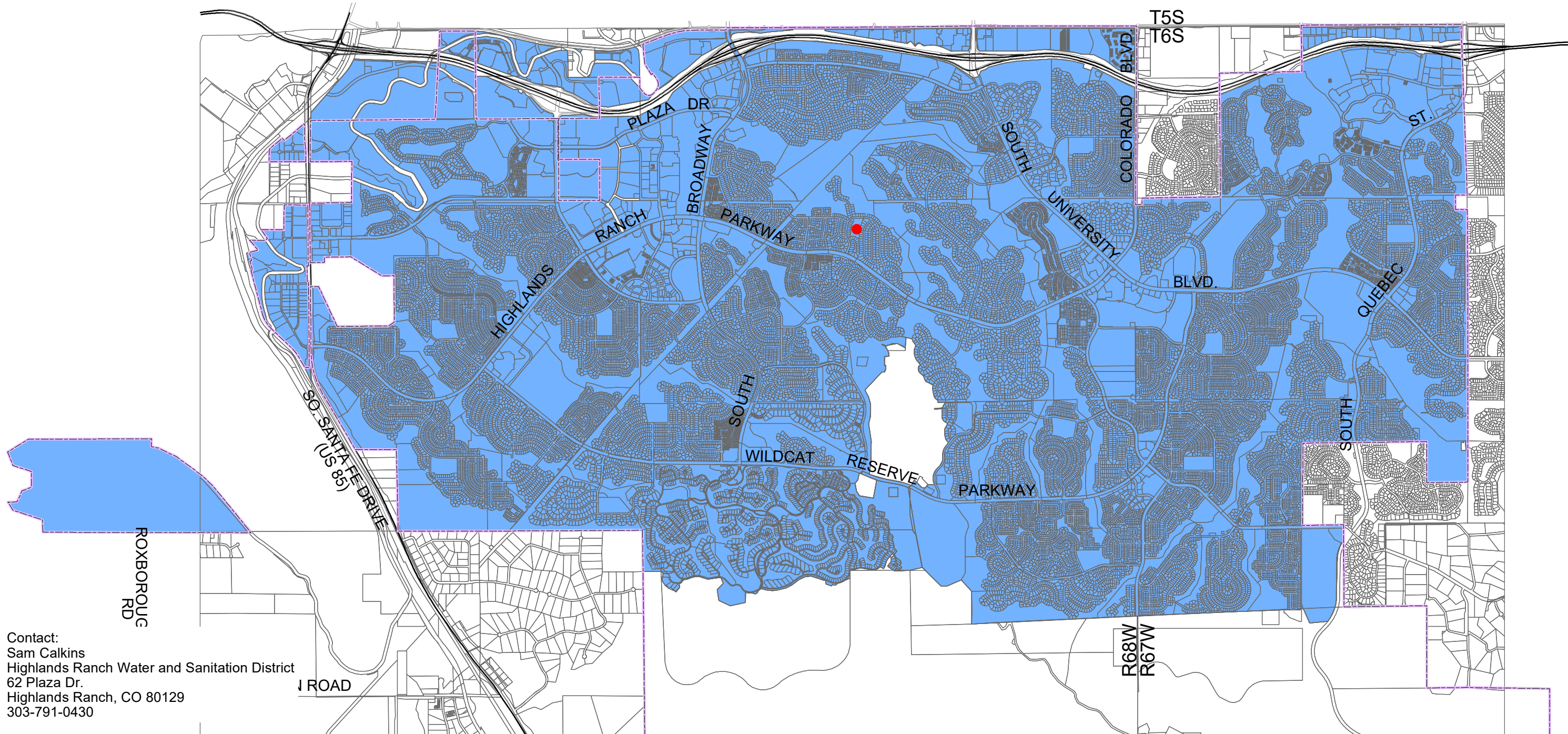
Sincerely,

Samuel L. Calkins  
General Manager

Cc: Ryan Edwards

Attachment: Water Right Decree List

Highlands Ranch WSD's Water Court Case Numbers								12/9/24
Water Right Description	Original Decree	Change Case Decree	Diligence/ Absolute Decrees				When next diligence due	
			First	Second	Third	Fourth		Fifth/Sixth
<b>Surface Water Rights</b>								
Plum Creek	W - 6072	85CW415 93CW177	NA					
Augmentation Plan/ Exchange	85CW415 19CW3257	93CW178	94CW286	02CW037	11CW244	19CW3140	1/31/2027	
So. Platte Direct	88CW222	93CW179	96CW219	04CW033	12CW184	19CW3222	11/30/2026	
Chatfield Storage	84CW411	93CW082 83CW184*	93CW081 95CW111	01CW101 02CW041	14CW3155 09CW076	21CW3183 17CW3176	24CW3140 6/30/2028 <b>TBD</b>	
So. Platte Reservoir	95CW239	93CW082	03CW295	12CW199	20CW3078		2/28/2028	
Highlands Ranch Reservoirs	79CW316 to 330		85CW288 to 294	89CW168	96CW124	03CW266	12CW291 19CW3139 2/28/2026	
Highlands Ranch Gulches	86CW332 to 336	95CW160 (Big Dry)	95CW159 to 164	02CW311 to 315	BD-11CW171 DC-11CW024 SPG-11CW129 MG-11CW130		Dropped Dropped Dropped Dropped	
Cline	99CW199(A)		08CW20	15CW3133	22CW3180		6/30/2029	
Fairview Senior Junior	84CW058 85CW314		01CW276	12CW119	18CW3222		8/31/2026	
Hock Hocking	W-1318		83CW214	87CW161	97CW222	04CW271	Completed	
Randall Ditch/ Tingle Res Junior Application	05CW111 09CW180		13CW3029 17CW3207	19CW3223 24CW3092			10/31/2026 11/30/2030	
CD Catholic Schools United Development	07CW62	18CW3188						
<b>Groundwater Rights</b>								
Dawson	82CW480							
Denver Trib	85CW415							
Denver Non-Trib	80CW445	97CW145 (locations)			88CV335 D-3 Settlemt			
Arapahoe	W-9192-78	84CW483 (locations)	84CW482 (diligence)	06CW202 (A-1 reloca.)				
Laramie-Foxhills	W-9192-78	83CW237 (locations)	83CW237					
Chatfield LFH	82CW479							
Willows Arap.(PA -5,7)	W-9310-78	90CW109	also	85CW163, 85CW170, 88CW079, and 99CW163			10CW171 PA-7	
Plum Creek Non-Trib	W-6072							

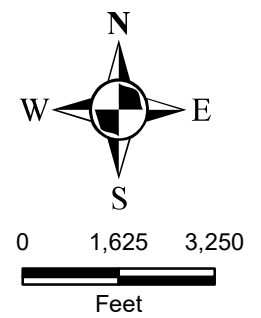


Contact:  
 Sam Calkins  
 Highlands Ranch Water and Sanitation District  
 62 Plaza Dr.  
 Highlands Ranch, CO 80129  
 303-791-0430

# Boundary Map Highlands Ranch Water and Sanitation District Tax Authority # 4058

● LGID 18025 - 39°32'53.23" N, 104°58'26.21" W

■ Highlands Ranch Water and Sanitation District



January 1, 2025



12600 West Colfax Avenue  
Suite A-270  
Lakewood, CO, 80215  
P: 303.350.4090



May 30, 2025

Douglas County Department of Community Development  
100 Third Street  
Castle Rock, Colorado 80104

Attn: Mr. Matt Jakubowski, AICP  
Chief Planner

Subject: Review of Water Supply and Demand for the Highlands Ranch Filing 157, Lots 3 and 4, File No. ZR2025-001.

Project No. 24822

Dear Matt,

Moore Engineering, Inc, dba Lytle Water Solutions, LLC ("LWS"), has reviewed the pertinent documents related to Lots 3 and 4 in Highlands Ranch Filing No. 157, File No. ZR2025-001. This property is comprised of 4.61 acres ("ac") on Lot 3 and 10.2 ac on Lot 4. This application is a major amendment to the Highlands Ranch Planned Development (PD), 80<sup>th</sup> Amendment, which seeks to add 400 residential units to Planning Area 85. Water service for this property will be provided by Highlands Ranch Water.

Highlands Ranch Water has provided a will-serve letter for this property, dated April 22, 2025, which commits to serve the proposed development described above. Based on the mix of uses within the parcel, it was estimated that the 400 residential units equates to 234 single family equivalents ("SFEs"). According to Highland Ranch Water's presumptive water demand of 0.50 acre-feet per year ("ac-ft/yr") per SFE, the total water demand for this proposed development is 117 ac-ft/yr.

According to an April 22, 2025 attachment to the will-serve letter, Highlands Ranch Water has 17,717 ac-ft/yr of Denver Basin aquifer water and an additional average-year yield from renewable sources of 12,870 ac-ft/yr. There was 1,000 ac-ft/yr of water from the Water Infrastructure System Efficiency ("WISE") project and 50 ac-ft/yr from Castle Pines North Metropolitan District included in Table 1 of the April 22 letter as renewable water sources. However, these supplies are not firm in a dry year analysis and, therefore, were excluded in our analysis. We also excluded the estimated yield from Chatfield Reservoir as no data have been provided that this is a firm yield.

Highlands Ranch Water has also stored approximately 14,700 ac-ft of treated water in the Denver Basin aquifers, which can be recovered through its existing Denver Basin wells. This provides additional flexibility in meeting demands during dry years; however, while it is an additional supply, this injected water is not considered a firm water supply as it doesn't provide a reliable, permanent water source.

Lytle Water Solutions is proud to be part of Moore Engineering, Inc., a 100% employee-owned company.

[mooreengineeringinc.com](http://mooreengineeringinc.com) | [lytlewater.com](http://lytlewater.com)

Highlands Ranch Water also has use of 3,885 ac-ft of water storage in McLellan Reservoir, 6,350 ac-ft of water storage in the South Platte River Reservoir, and 205 ac-ft of water storage in the James Tingle Reservoir. Highlands Ranch Water is also participating in the Chatfield Reservoir re-allocation project, with a storage subscription of 7,000 ac-ft and an estimated future average-year yield of 2,500 ac-ft. This allows Highlands Ranch Water the ability to carryover water in storage from wet to dry years to firm its water supply yields. Given these supplies, Highlands Ranch Water currently has a firm average-year supply in excess of 30,000 ac-ft/yr, with the ability to manage this supply through multiple storage projects.

Highlands Ranch Water estimates that its buildout demand will be in the range of 19,600-22,600 ac-ft/yr. According to its April 22 will-serve letter, Highlands Ranch Water's current water demand has not exceeded 17,000 ac-ft/yr. As such, Highlands Ranch Water currently has over 13,000 ac-ft/yr of excess water supply available, including service to the Highlands Ranch Filing No. 157, Lots 3 and 4, and approximately 8,000 ac-ft of excess supply at buildout.

In summary, it is our opinion that Highlands Ranch Water has sufficient water to serve this proposed development. If you have questions regarding our review of the Highlands Ranch Filing No. 157, Lots 3 and 4 application, please feel free to give us a call.

Yours truly,



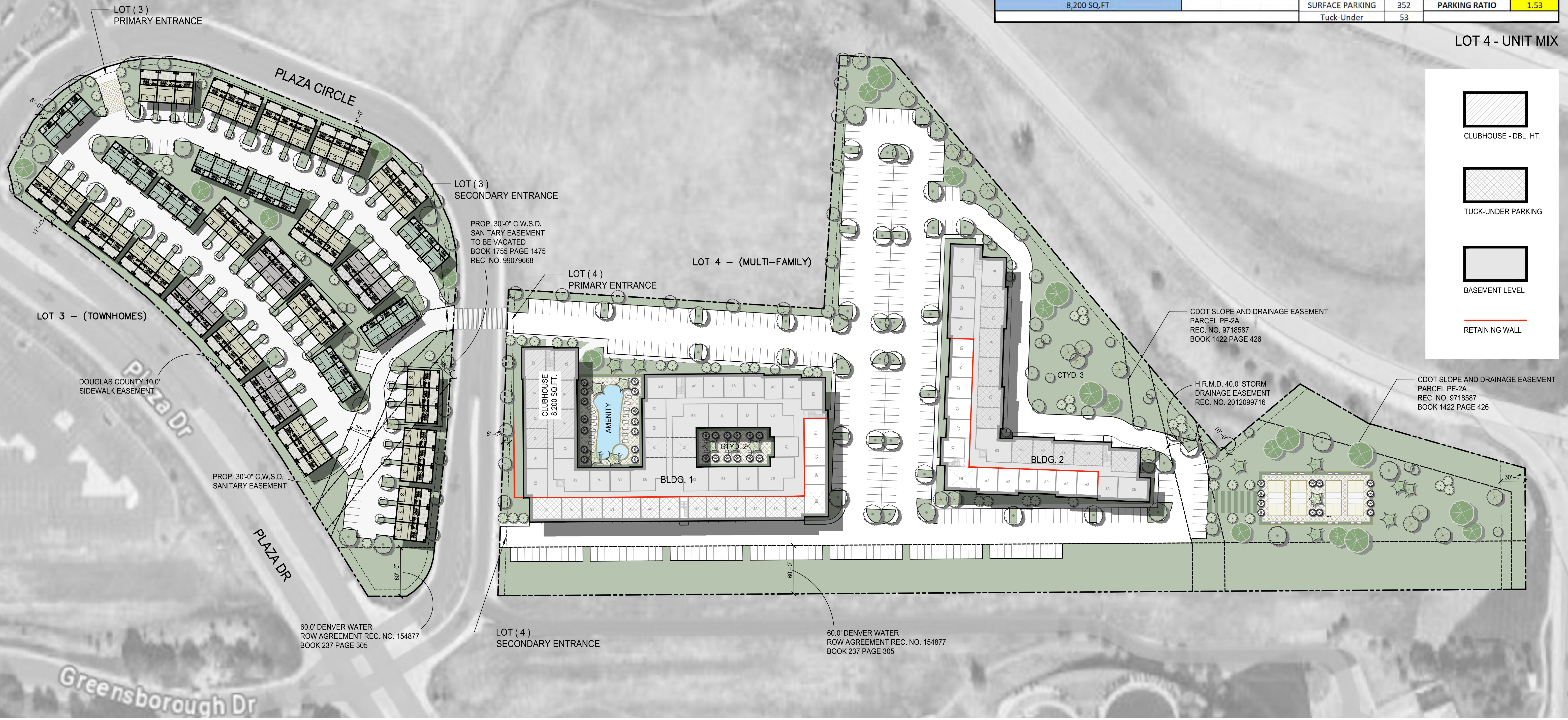
Bruce A. Lytle, P.E.  
Senior Project Manager

UNITS				TOTALS			
UNIT TYPE	DESCRIPTION	NET SQ. FT.	GROSS SQ. FT.	TOTAL NO. OF UNITS	UNIT %	NET SQ. FT. PER UNIT TYPE	GROSS SQ. FT. PER UNIT TYPE
B	2 BED / 2.5 BATH	1,274	1,734	24	28.6%	30,576	41,616
C	3 BED / 2.5 BATH	1,475	1,935	48	57.1%	70,800	92,880
D	4 BED / 2.5 BATH	1,722	2,182	12	14.3%	20,664	26,184
				<b>TOTAL</b>	<b>84</b>	<b>122,040</b>	<b>160,680</b>
AVERAGE UNIT SIZE					100%		
							1,453

LOT 3 - UNIT MIX

HIGHLANDS RANCH - UNIT MIX													
UNITS				BUILDING					UNIT %	NET SF TOTAL	GROSS SF TOTAL		
NAME	BEDS	NET	GROSS	SUB	LVL 1	LVL 2	LVL 3	TOTAL					
A0	1 BED	650	675	4	10	15	15	44	173	28600	29700		
A1	1 BED	725	750	12	17	26	26	81		58725	60750		
A2	1 BED	825	850	3	15	15	15	48		39600	40800		
									<b>66%</b>				
B1	2 BED	1060	1105	4	9	12	12	37	91	39220	40885		
B2	2 BED	1175	1225	4	4	9	9	26		30550	31850		
B3	2 BED + STUDY	1444	1494	7	7	7	7	28		40432	41832		
									<b>34%</b>				
<b>TOTAL</b>									<b>264</b>	<b>237127</b>	<b>245817</b>		
									<b>100%</b>				
AVERAGE UNIT SIZE													
898													
CLUBHOUSE													
8,200 SQ.FT													
									<b>PARKING TOTALS</b>		<b>TOTAL PARKING</b>	<b>405</b>	
									SURFACE PARKING		352	<b>PARKING RATIO</b>	<b>1.53</b>
									Tuck-Under		53		

LOT 4 - UNIT MIX



1 SITE PLAN  
1"=60'-0"

# SITE PLAN - HIGHLANDS RANCH APARTMENTS

HIGHLANDS RANCH, CO - PAGESWEST

**MEEKS PARTNERS**  
16000 Memorial Drive  
Suite 100  
Houston, Texas 77079  
281558.8787

10.30.2025  
**A-01**  
JOB NO. 23095

Highlands Ranch Planned Development, 84th Amendment  
Project File: ZR2026-002  
Board of County Commissioners Staff Report - Page 290 of 292

These are copyright and are subject to copyright protection as an "architectural work" under Section 102 of the Copyright Act, 17 U.S.C. as amended December 1, 1990, and known as the Architectural Works Protection Act of 1990. This protection includes but is not limited to, the overall form as well as the arrangement and disposition of space and elements of the design. Under such protection, unauthorized use of these plans, whether in whole or in part, for the construction of any building or structure, or the reproduction of any such building or structure, without the written consent of MEEKS PARTNERS, is prohibited. © 2018 M.P.P., CO.

**URBAN USES**

RESIDENTIAL DENSITY-LOW 1,5,7,23 & 51	PA <sup>1</sup>	GRA <sup>2</sup>	DU/GRA <sup>4</sup>	TOTAL DU
1	165	2.6		433
2	66	3.2		212
3	165	3.6		594
4	51	2.0		102
5	53	3.8		198
7	194	2.9		562
23	64	1.6		104
51	77	3.2		246
<b>SUB TOTAL</b>	<b>835</b>	<b>2.9</b>		<b>2,451</b>

MEDIUM-LOW 20,24-32,52,57 & 58	PA <sup>1</sup>	GRA <sup>2</sup>	DU/GRA <sup>4</sup>	TOTAL DU
6	87	4.9		429
20	353	4.3		1,518
24	185	4.0		740
25	77	4.0		308
26	234	4.0		936
27	95	4.0		380
28	94	4.0		376
29	108	4.0		432
30	91	4.0		364
31	253	4.1		1,032
32	187	4.0		748
52	226	4.4		1,004
57	391	4.4		1,737
58	336	4.2		1,400
<b>SUB TOTAL</b>	<b>2,717</b>	<b>4.2</b>		<b>11,404</b>

MEDIUM 33,40-50,53-56 & 59	PA <sup>1</sup>	GRA <sup>2</sup>	DU/GRA <sup>4</sup>	TOTAL DU
33	65	6.4		419
40	87	5.3		465
41	216	5.3		1,134
42	43	5.9		275
43	179	5.0		893
44	186	5.0		957
45	86	5.0		430
46	224	5.9		1,330
47	46	5.0		230
48	72	5.0		360
49	98	5.0		490
50	181	5.0		905
53	154	5.0		770
54	47	5.6		265
55	258	5.8		1,493
56	101	5.0		505
59	362	4.8		1,749
<b>SUB TOTAL</b>	<b>2,405</b>	<b>5.3</b>		<b>12,670</b>

For the addition of residential dwelling units to the PD, the following changes are proposed:  
 -Add new line under High for PA 85 with:  
 -GRA: --  
 -DU/GRA: 8.0-25.0  
 -Total DU: 350  
 -Update High Sub Total:  
 - DU/GRA: 8.0 - 25.0  
 - Total DU: 9,893  
 -Update Total Residential:  
 -Total DU: 36,418

HIGH 60-69	PA <sup>1</sup>	GRA <sup>2</sup>	DU/GRA <sup>4</sup>	TOTAL DU
60	32	8.0-15.0		284
61	168	8.0-15.0		1,794
62	51	8.0-15.0		447
63	35	8.0-15.0		280
64	98	8.0-15.0		863
65	151	8.0-15.0		2,187
66	229	8.0-15.0		1,832
67	44	8.0-15.0		456
68	17	8.0-15.0		255
69	36	8.0-15.0		725
84,87	--	--		135
85-A	--	--		285
<b>SUB TOTAL</b>	<b>861</b>	<b>8.0-15.0</b>		<b>9,543</b>
<b>TOTAL RESIDENTIAL</b>	<b>6,818</b>			<b>36,068</b>

NONRESIDENTIAL	PA <sup>2</sup>	GNA <sup>3</sup>
70, 89-91	70	85
COMMUNITY ACTIVITY CENTER	89	11
	90	13
	91	14
71	71	151
CIVIC CENTER	72	173
TOWN CENTER	73	286
74	74	132
CORRIDOR ACTIVITY CENTER	13	13
SHOP-N-RIDE	75	45
INDUSTRIAL PARK	76	57
	77	107
	78	80
	79	12
	80	61
	81	40
	84	72
	85	69
	86	27
	87	15
	88	8
<b>SUB TOTAL</b>	<b>1,471</b>	

CIRCULATION	TOTAL ARTERIALS	TOTAL NONRESIDENTIAL
2 LANE ARTERIAL HIGHWAYS	443	1,914
4 LANE ARTERIAL HIGHWAYS		
6 LANE ARTERIAL HIGHWAYS		

**NON-URBAN USES**

SCHOOLS	GNA <sup>3</sup>
E ELEMENTARY SCHOOLS	462
MS MIDDLE SCHOOL	
HS HIGH SCHOOL	
L LIBRARY	3
P MASS TRANSIT PARKING SITE	7
RP REGIONAL PARK	300
A HIGHLANDS RANCH COMMUNITY ASSOCIATION FACILITY SITE	35
CP COMMUNITY PARK	160
NONURBAN	
EASEMENTS	600
FLOODPLAINS (100 YR.)	741
REMAINING AREA	2,382

OPEN SPACE CONSERVATION AREA	PA	GNA <sup>3</sup>
A	467	
B	87	
C	191	
D	87	
E	272	
F	34	
G	19	
H	10	
I	33	
<b>SUBTOTAL</b>	<b>1,200</b>	
J	125	
	6,875	
	7,000	
<b>TOTAL OPEN SPACE CONSERVATION AREA</b>	<b>8,200</b>	

**TOTAL NONURBAN 12,890**

**TOTAL PLANNED COMMUNITY DISTRICT (ACRES) 21,622**

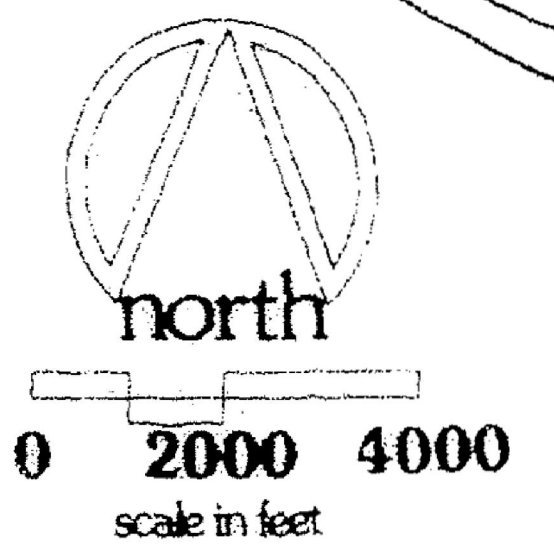
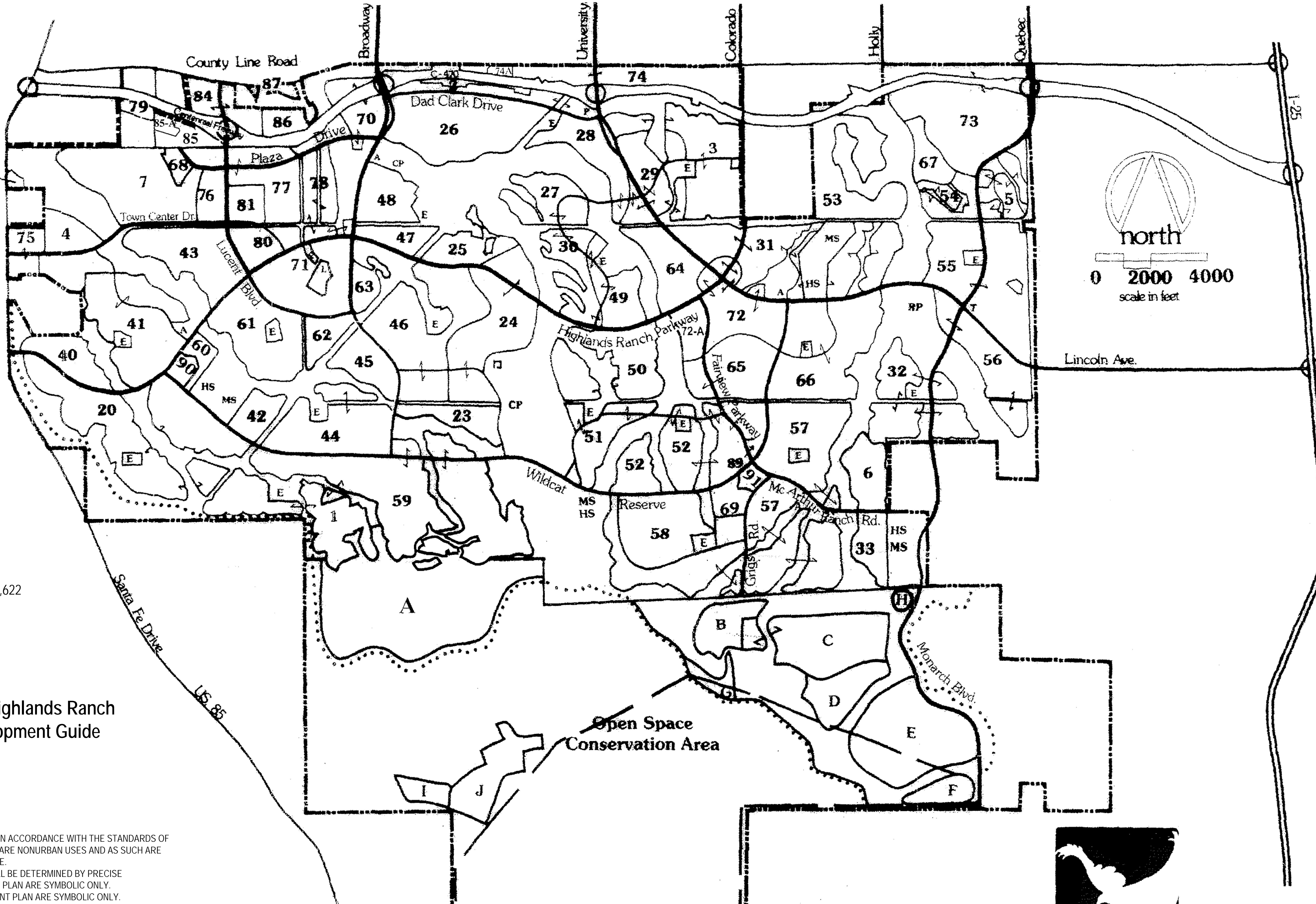
**Section XVIII of the New Town of Highlands Ranch Planned Community District Development Guide**

FOOTNOTES:  
<sup>1</sup>PLANNING AREA  
<sup>2</sup>GROSS RESIDENTIAL ACRES  
<sup>3</sup>GROSS NONRESIDENTIAL ACRES  
<sup>4</sup>DWELLING UNITS/GROSS RESIDENTIAL ACRE

GENERAL NOTES:  
 1: SCHOOL SITES WILL BE PRECISELY SCALED AND LOCATED IN ACCORDANCE WITH THE STANDARDS OF THE DOUGLAS COUNTY SCHOOL DISTRICT. SCHOOL SITES ARE NONURBAN USES AND AS SUCH ARE NOT A PART OF THE RESIDENTIAL PLANNING AREA ACREAGE.  
 2: THE SPECIFIC LOCATIONS AND SIZES OF SHOP-N-RIDES WILL BE DETERMINED BY PRECISE ENGINEERING STUDIES. THE FACILITIES INDICATED ON THE PLAN ARE SYMBOLIC ONLY.  
 3: COMMUNITY PARK SITES DESIGNATED ON THE DEVELOPMENT PLAN ARE SYMBOLIC ONLY.  
 4: PLANNING AREA BOUNDARIES OTHER THAN THOSE DELINEATED BY STREETS ARE SHOWN BY THE FOLLOWING SYMBOL:  
 5: HIGHLANDS RANCH BOUNDARY IS SHOWN BY THE FOLLOWING SYMBOL:  
 6: OFF-STREET HIKING AND BIKING TRAIL  
 7: THE CULTURAL AND HISTORICAL PROTECTION OVERLAY ZONE IS DELINEATED BY THE FOLLOWING SYMBOL:  
 8: SOME NONURBAN AREAS EXIST INTERIOR TO ADJACENT PLANNING AREAS, AND ARE NOT GRAPHICALLY REPRESENTED. THESE NONURBAN AREAS REMAIN SUBJECT TO SECTION XIII OF THE HIGHLANDS RANCH DEVELOPMENT GUIDE.

I HEREBY CERTIFY THAT THIS PLAN WAS FILED IN MY OFFICE ON THIS \_\_\_\_ DAY OF \_\_\_\_ 20\_\_\_\_ A.D. AT \_\_\_\_ O'CLOCK A.M./P.M., AND WAS RECORDED PER RECEPTION NO. \_\_\_\_\_  
 Douglas County Clerk and Recorder

THIS MAJOR AMENDMENT OF THE HIGHLANDS RANCH PLANNED DEVELOPMENT PLAN AMENDING THE TOTAL RESIDENTIAL DWELLING UNITS AND ADJUSTING THE BOUNDARY OF PLANNING AREA 43 AS DEPICTED ON THE HIGHLANDS RANCH DEVELOPMENT PLAN ZONING MAP AS DEPICTED HEREON HAS BEEN APPROVED BY BOARD MOTION NO. \_\_\_\_ ON \_\_\_\_ 20\_\_\_\_.  
 THIS AMENDMENT NO. 77 AFFECTS ONLY PLANNING AREA 43 AS DESCRIBED IN FILE NO. ZR2022-011.  
 Chair, Board of Douglas County Commissioners Date  
 Director of Community Development Date

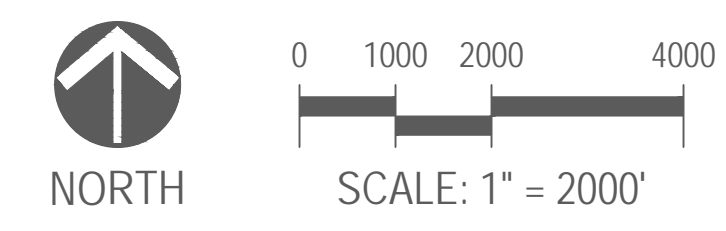


Updated to read:  
 THIS MAJOR AMENDMENT OF THE HIGHLANDS RANCH PLANNED DEVELOPMENT PLAN AMENDING THE TOTAL RESIDENTIAL DWELLING UNITS IN PLANNING AREA 85 AS DEPICTED HEREON HAS BEEN APPROVED BY BOARD MOTION NO. \_\_\_\_ ON \_\_\_\_ 2026.

Update to:  
 AMENDMENT NO. 84  
 ZR2026-002  
 (File No. TBD)

Update to read:  
 THIS AMENDMENT NO. 84 AFFECTS ONLY PLANNING AREA 85 AS DESCRIBED IN FILE NO. ZR2026-002.

**HIGHLANDS RANCH**  
 PLANNED COMMUNITY DISTRICT  
 DEVELOPMENT PLAN  
 ZONING MAP  
 AMENDMENT NO. 77  
 ZR2022-011  
 PAGE 1 OF 1



Removed per staff instruction.

**URBAN USES**

RESIDENTIAL DENSITY-LOW 1,5,7,23 & 51	PA <sup>1</sup>	GRA <sup>2</sup>	DUI/GRA <sup>4</sup>	TOTAL DU
1	165	2.6		433
2	66	3.2		212
3	165	3.6		594
4	51	2.0		102
5	53	3.8		198
7	194	2.9		562
23	64	1.6		104
51	77	3.2		246
<b>SUB TOTAL</b>	<b>835</b>	<b>2.9</b>		<b>2,451</b>

MEDIUM-LOW 20,24-32,52,57 & 58	PA <sup>1</sup>	GRA <sup>2</sup>	DUI/GRA <sup>4</sup>	TOTAL DU
6	87	4.9		429
20	353	4.3		1,518
24	185	4.0		740
25	77	4.0		308
26	234	4.0		936
27	95	4.0		380
28	94	4.0		376
29	108	4.0		432
30	91	4.0		364
31	253	4.1		1,032
32	187	4.0		748
52	226	4.4		1,004
57	391	4.4		1,737
58	336	4.2		1,400
<b>SUB TOTAL</b>	<b>2,717</b>	<b>4.2</b>		<b>11,404</b>

MEDIUM 33,40-50,53-56 & 59	PA <sup>1</sup>	GRA <sup>2</sup>	DUI/GRA <sup>4</sup>	TOTAL DU
33	65	6.4		419
40	87	5.3		465
41	216	5.3		1,134
42	43	5.9		275
43	179	5.0		893
44	186	5.0		957
45	86	5.0		430
46	224	5.9		1,330
47	46	5.0		230
48	72	5.0		360
49	98	5.0		490
50	181	5.0		905
53	154	5.0		770
54	47	5.6		265
55	258	5.8		1,493
56	101	5.0		505
59	362	4.8		1,749
<b>SUB TOTAL</b>	<b>2,405</b>	<b>5.3</b>		<b>12,670</b>

HIGH 60-69	PA <sup>1</sup>	GRA <sup>2</sup>	DUI/GRA <sup>4</sup>	TOTAL DU
60	32	8.0-15.0		284
61	168	8.0-15.0		1,794
62	51	8.0-15.0		447
63	35	8.0-15.0		280
64	98	8.0-15.0		863
65	151	8.0-15.0		2,187
66	229	8.0-15.0		1,832
67	44	8.0-15.0		456
68	17	8.0-15.0		255
69	36	8.0-15.0		725
84,87	--	--		135
85	--	8.0-25.0		350
85-A	--	--		285
<b>SUB TOTAL</b>	<b>861</b>	<b>8.0-25.0</b>		<b>9,983</b>

**TOTAL RESIDENTIAL 6,818 36,418**

NONRESIDENTIAL	PA <sup>2</sup>	GNA <sup>3</sup>
70, 89-91 COMMUNITY ACTIVITY CENTER	70	85
	89	11
	90	13
	91	14
71 CIVIC CENTER	71	151
72,73 TOWN CENTER	72	173
	73	286
74 CORRIDOR ACTIVITY CENTER	74	132
T SHOP-N-RIDE		13
75-88 INDUSTRIAL PARK	75	45
	76	57
	77	107
	78	80
	79	12
	80	61
	81	40
	84	72
	85	69
	86	27
	87	15
	88	8
<b>SUB TOTAL</b>	<b>1,471</b>	

CIRCULATION	TOTAL ARTERIALS	TOTAL NONRESIDENTIAL
2 LANE ARTERIAL HIGHWAYS	443	1,914
4 LANE ARTERIAL HIGHWAYS		
6 LANE ARTERIAL HIGHWAYS		

**NON-URBAN USES**

SCHOOLS	GNA <sup>3</sup>
E ELEMENTARY SCHOOLS	462
MS MIDDLE SCHOOL	
HS HIGH SCHOOL	
L LIBRARY	3
P MASS TRANSIT PARKING SITE	7
RP REGIONAL PARK	300
A HIGHLANDS RANCH COMMUNITY ASSOCIATION FACILITY SITE	35
CP COMMUNITY PARK	160
NONURBAN EASEMENTS	600
FLOODPLAINS (100 YR.)	741
REMAINING AREA	2,382

OPEN SPACE CONSERVATION AREA	GNA <sup>3</sup>
PA	467
A	87
B	191
C	87
D	272
E	34
F	19
G	10
H	33
I	125
J	125
<b>SUBTOTAL</b>	<b>1,200</b>
TOTAL OPEN SPACE CONSERVATION AREA	<b>7,000</b>
<b>TOTAL NONURBAN</b>	<b>12,890</b>

**TOTAL PLANNED COMMUNITY DISTRICT (ACRES) 21,622**

**Section XVIII of the New Town of Highlands Ranch Planned Community District Development Guide**

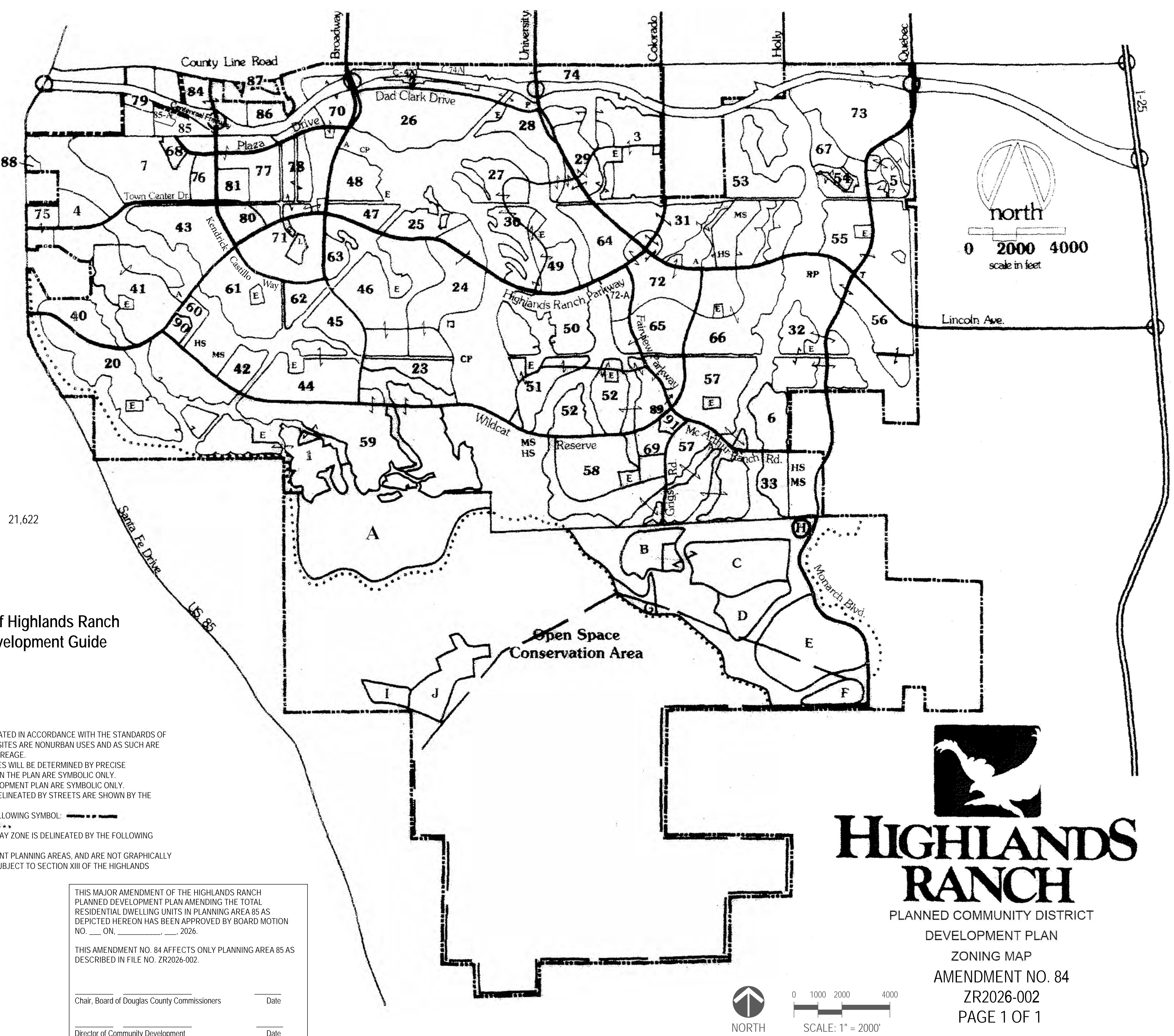
**FOOTNOTES:**  
<sup>1</sup>PLANNING AREA  
<sup>2</sup>GROSS RESIDENTIAL ACRES  
<sup>3</sup>GROSS NONRESIDENTIAL ACRES  
<sup>4</sup>DWELLING UNITS/GROSS RESIDENTIAL ACRE

**GENERAL NOTES:**  
 1: SCHOOL SITES WILL BE PRECISELY SCALED AND LOCATED IN ACCORDANCE WITH THE STANDARDS OF THE DOUGLAS COUNTY SCHOOL DISTRICT. SCHOOL SITES ARE NONURBAN USES AND AS SUCH ARE NOT A PART OF THE RESIDENTIAL PLANNING AREA ACREAGE.  
 2: THE SPECIFIC LOCATIONS AND SIZES OF SHOP-N-RIDES WILL BE DETERMINED BY PRECISE ENGINEERING STUDIES. THE FACILITIES INDICATED ON THE PLAN ARE SYMBOLIC ONLY.  
 3: COMMUNITY PARK SITES DESIGNATED ON THE DEVELOPMENT PLAN ARE SYMBOLIC ONLY.  
 4: PLANNING AREA BOUNDARIES OTHER THAN THOSE DELINEATED BY STREETS ARE SHOWN BY THE FOLLOWING SYMBOL: \_\_\_\_\_  
 5: HIGHLANDS RANCH BOUNDARY IS SHOWN BY THE FOLLOWING SYMBOL: \_\_\_\_\_  
 6: OFF-STREET HIKING AND BIKING TRAIL \_\_\_\_\_  
 7: THE CULTURAL AND HISTORICAL PROTECTION OVERLAY ZONE IS DELINEATED BY THE FOLLOWING SYMBOL: \_\_\_\_\_  
 8: SOME NONURBAN AREAS EXIST INTERIOR TO ADJACENT PLANNING AREAS, AND ARE NOT GRAPHICALLY REPRESENTED. THESE NONURBAN AREAS REMAIN SUBJECT TO SECTION XIII OF THE HIGHLANDS RANCH DEVELOPMENT GUIDE.

THIS MAJOR AMENDMENT OF THE HIGHLANDS RANCH PLANNED DEVELOPMENT PLAN AMENDING THE TOTAL RESIDENTIAL DWELLING UNITS IN PLANNING AREA 85 AS DEPICTED HEREON HAS BEEN APPROVED BY BOARD MOTION NO. \_\_\_ ON \_\_\_, 2026.

THIS AMENDMENT NO. 84 AFFECTS ONLY PLANNING AREA 85 AS DESCRIBED IN FILE NO. ZR2026-002.

Chair, Board of Douglas County Commissioners \_\_\_\_\_ Date \_\_\_\_\_  
 Director of Community Development \_\_\_\_\_ Date \_\_\_\_\_



**PLANNED COMMUNITY DISTRICT DEVELOPMENT PLAN**  
**ZONING MAP**  
**AMENDMENT NO. 84**  
**ZR2026-002**  
**PAGE 1 OF 1**

